



INTEROPERABILITY UNIT

TAP TSI: ANNEX B.10

**ELECTRONIC RESERVATION OF ASSISTANCE FOR PERSONS WITH REDUCED MOBILITY -
EXCHANGE OF MESSAGES**

REFERENCE: ERA/TD/2010-01/INT

DOCUMENT TYPE: TECHNICAL DOCUMENT

VERSION: 1.3 FINAL

TAP TSI

DATE: 10.02.2015

AMENDMENT RECORD

Version	Date	Section number	Modification/description
1.1	05.05.2011	All sections	First release
1.2	16.01.2013	All sections 8.2.1 All sections	Correction of text errors discovered in TAP TSI phase 1 Introduction of a self-contained message catalogue Including ticket vendors as requesting party
1.3	09.01.2015		Numbering changes

Introduction

The present document belongs to the set of Technical Documents described in Annex III 'List of Technical Documents referenced in TAP TSI' of the COMMISSION REGULATION (EU) No 454/2011.

**Electronic reservation of assistance for persons with
reduced mobility - Exchange of messages**

Application:

With effect from 30 April 2015.

All actors of the European Union falling under the provisions of the TAP TSI.

1 Content

1	CONTENT	6
2	SUMMARY	8
3	OVERVIEW	9
4	STAKEHOLDERS INVOLVED IN BOOKING OF PRM ASSISTANCE	10
5	USE CASE MODEL	11
6	STRUCTURAL MODEL FOR PRM BOOKING STANDARD	15
6.1	DEFINITION OF DATA MODEL	15
6.2	ENTITY „ADDRESS“	17
6.3	ENTITY „ASSISTANCE“	18
6.4	ENTITY „BOOKING“	18
6.5	ENTITY „CUSTOMER“	18
6.6	ENTITY „HANDICAP“	18
6.7	ENTITY „HANDICAPPEDCARD“	19
6.6	ENTITY „LOCALFACILITY“	19
6.9	ENTITY „ONBOARDFACILITY“	19
6.10	ENTITY „PLATFORM“	19
6.11	ENTITY „PRM“	20
6.12	ENTITY „PRMBOOKINGSYSTEM“	20
6.13	ENTITY „STATION“	20
6.14	ENTITY „TOOLS“	20
6.15	ENTITY „TRAIN“	21
6.16	ENTITY „TRAIN STOP“	21
6.17	DEFINITION OF CODE LISTS.....	22
6.17.1	<i>Booking Type : see ERA code list B.10.1</i>	22
6.17.2	<i>Facilities for Assistance: see ERA code list B.10.2</i>	22
6.17.3	<i>Meeting points: see ERA code list B.10.3</i>	22
6.17.4	<i>Disability: see ERA code list B.10.4</i>	22
6.17.5	<i>LocalFacility: see ERA code list B.10.5</i>	22
6.17.6	<i>OnBoardFacility: see ERA code list B.10.6</i>	22
6.17.7	<i>Reply Codes: see ERA code list B.10.7</i>	22
7	FUNCTIONAL MODEL FOR PRM BOOKING STANDARD	23
7.1	AVAILABILITY AND BOOKING WITHOUT FAILURE	24
7.2	CANCELLATION	25
7.3	ERROR SCENARIO – LOST COMMUNICATION	26
7.4	MANUAL BOOKING WITHOUT FAILURE.....	27
7.5	MANUAL BOOKING WITH FAILURE	28
7.6	REQUEST STATUS.....	29
8	XML MESSAGE SPECIFICATION	30
8.1	XML MESSAGE SPECIFICATION BASICS	30
8.1.1	<i>Foundations</i>	30
8.1.2	<i>Name spaces</i>	30
8.1.3	<i>Character Sets</i>	30
8.2	XML SPECIFICATION DOCUMENTS.....	30
8.2.1	<i>Schema files</i>	30
8.2.2	<i>Imported schema files</i>	Error! Bookmark not defined.
8.3	ADDITIONAL DOCUMENTATION FILES	ERROR! BOOKMARK NOT DEFINED.
8.4	REFERENCED DOCUMENTATION FILES	31

European Railway Agency

ERA/TD/2010-01/INT: ANNEX B.10 of TAP TSI

8.5	XML VERSIONING	31
8.6	XML VERSIONS	31
8.6.1	Version 01	31
8.7	RECOMMENDATIONS FOR XML IMPLEMENTATION.....	31
9	ABBREVIATIONS	33
10	REFERENCED DOCUMENTS	34
Figure 1	use cases with customers	13
Figure 2	use cases without customer	14
Figure 3	use case “contact customer” (outside the system)	15
Figure 4	object diagram	17
Figure 5	sequence diagram - availability and booking	24
Figure 6	sequence diagram - cancellation.....	25
Figure 7	sequence diagram – error handling.....	26
Figure 8	sequence diagram – manual booking	27
Figure 9	sequence diagram – manual booking with failure	28
Figure 10	sequence diagram – request status for information	29
Table 1	Actors.....	10
Table 2	Systems	10
Table 3	Use Cases.....	12
Table 4	Data Entities.....	16
Table 5	sequence diagrams	23

2 Summary

This Technical Document describes the regulations and procedures to be observed when exchanging messages between actors that have to book assistance for persons with reduced mobility (PRM) at stations.

The arrangements contained in this Technical Document enable an RU to request assistance for a PRM at a station managed by another RU, IM or SM.

This Technical Document is accompanied by XSD schema files defining the messages. These schema files are part of the Technical Document. Future changes of the Technical Document have to ensure to keep the model definition in the Technical Document and the accompanying schema files consistent.

The Technical Document is accompanied by an XSD schema file documentation generated from the schema files. This documentation is provided for the convenience of the reader only, the valid specification is defined in the schema files.

This Technical Document does not cover the processes needed for organizing the assistance between the different actors involved

3 Overview

This Technical Document defines messages and functions to be used for requesting the availability of assistance and to book assistance. The messages support an automatic allocation system and an allocation system including manual steps for allocation of assistance. Both implementation models are fully interoperable.

The Technical Document consists of the following parts:

- **Stakeholders**

All systems and roles involved in the booking of assistance are defined if they are required for the booking functionality specified in the Technical Document.

- **Use Cases**

All Use Cases supported by the specification are listed.

- **Structural Model**

The structural model provides a data model for all information object involved. The structural model is the base reference for the exchange of information defined by the messages.

- **Functional Model**

The functional model defines the scenarios as sequence diagrams and links the functions with the messages used.

- **Message definition**

The message definition refers to the XML schema files and the documentation generated from the schemas. This section specifies additionally the versioning of the messages.

The diagrams used in this document follow the UML 2 specification.

4 Stakeholders involved in booking of PRM assistance

Actor	Description
PRM customer	Person with reduced mobility for which the assistance is required
Accompanying Person of PRM	Person accompanying the PRM on his/her journey or at least on the part of the journey where the assistance is required.
Contact Person of PRM	Person to be contacted in case of problems in providing the assistance
Point of Sale	Point of Sale, where the Customer is requesting the assistance for the whole journey. This includes also travel agencies, internet booking functions and call center.
Assistance coordinator of the requesting RU	Coordinator of the assistance booking at the RU handling the customer request (Point of Sale). This is the person, who receives the customer requests for assistance on the whole journey
Assistance coordinator of allocating RU, IM or SM (=Station Coordinator)	This is the person handling the requests for assistance on a set of stations.
staff on board/station	This is the staff in the station or on board providing the assistance to the PRM.

Table 1 Actors

System	Description
Requesting system	System to request availability and booking of PRM assistance via the specified interface. The system is responsible for requests of the RU/ticket vendor of the Point of Sale.
Allocating system	System to receive requests for availability and booking of PRM assistance. The system is responsible for a set of stations.

Table 2 Systems

5 Use Case Model

The use cases are defined to support two different implementations:

Implemented as a synchronous booking function the booking would be made directly by a booking system and the booking reply would be given instantaneously. This implementation is called "synchronous model" during the description. The rules for the decision to provide or not to provide assistance must be formally defined and implemented in the system.

The process flow would be less complex in this case, but the implementation would be complex.

An asynchronous booking function would only implement the process flow and standardize the existing processes. This implementation is called "workflow model" during the description. The booking itself would be organized manually by the coordinator of the requesting RU and the coordinators responsible for the stations of RUs, IMs or SMs. In this implementation there are additional use cases for the tasks of the coordinators. There is also an additional use case for the customer, as the customer does not get an immediate confirmation, so there must be a possibility for the customer to request the booking status later.

Use Case	Description
Request facilities and availability of assistance on station	Requesting the availability of assistance at stations or the available facilities at a station or on board either by the customer (i.e. via Internet) or a sales office or a call center.
Book assistance for journey at stations	Request booking of assistance either by the customer (i.e. via Internet) or a sales office or a call center.
Cancel Booking request	Request to cancel a booking or booking request by the customer (i.e. via Internet) or a sales office or a call center.
Retrieve booking status	Request the status of a booking by the customer (i.e. via Internet) or a sales office or a call center. This use case is part of the use cases needed in case of manual asynchronous booking procedures. The use case is used in synchronous booking functions for error handling.
Inform customer on failed booking	Inform the customer in case, that the assistance can not be provided as requested. This use case is part of the use cases needed in case of manual asynchronous booking procedures. Additional information on alternatives might be given.
Forward booking request to coordinator of stations	The coordinator of the requesting RU forwards the request to the system responsible for the station. This use case is part of the use cases needed in case of manual asynchronous booking procedures. In case of synchronous booking systems

European Railway Agency

ERA/TD/2010-01/INT: ANNEX B.10 of TAP TSI

	those would have to implement the functionality internally.
Cancel rest of failed booking	The coordinator of the requesting RU cancels the requests he has sent to other systems in case that one of the systems could not book the assistance. This use case is part of the use cases needed in case of manual asynchronous booking procedures. In case of synchronous booking systems those would have to implement the functionality internally.
Inform requesting RU on booking results	The coordinator of the stations informs the requesting RU system on the success or failure of the booking. This use case is part of the use cases needed in case of manual asynchronous booking procedures. In case of synchronous booking systems those would have to implement the functionality internally.

Table 3 Use Cases

The defined use cases are:

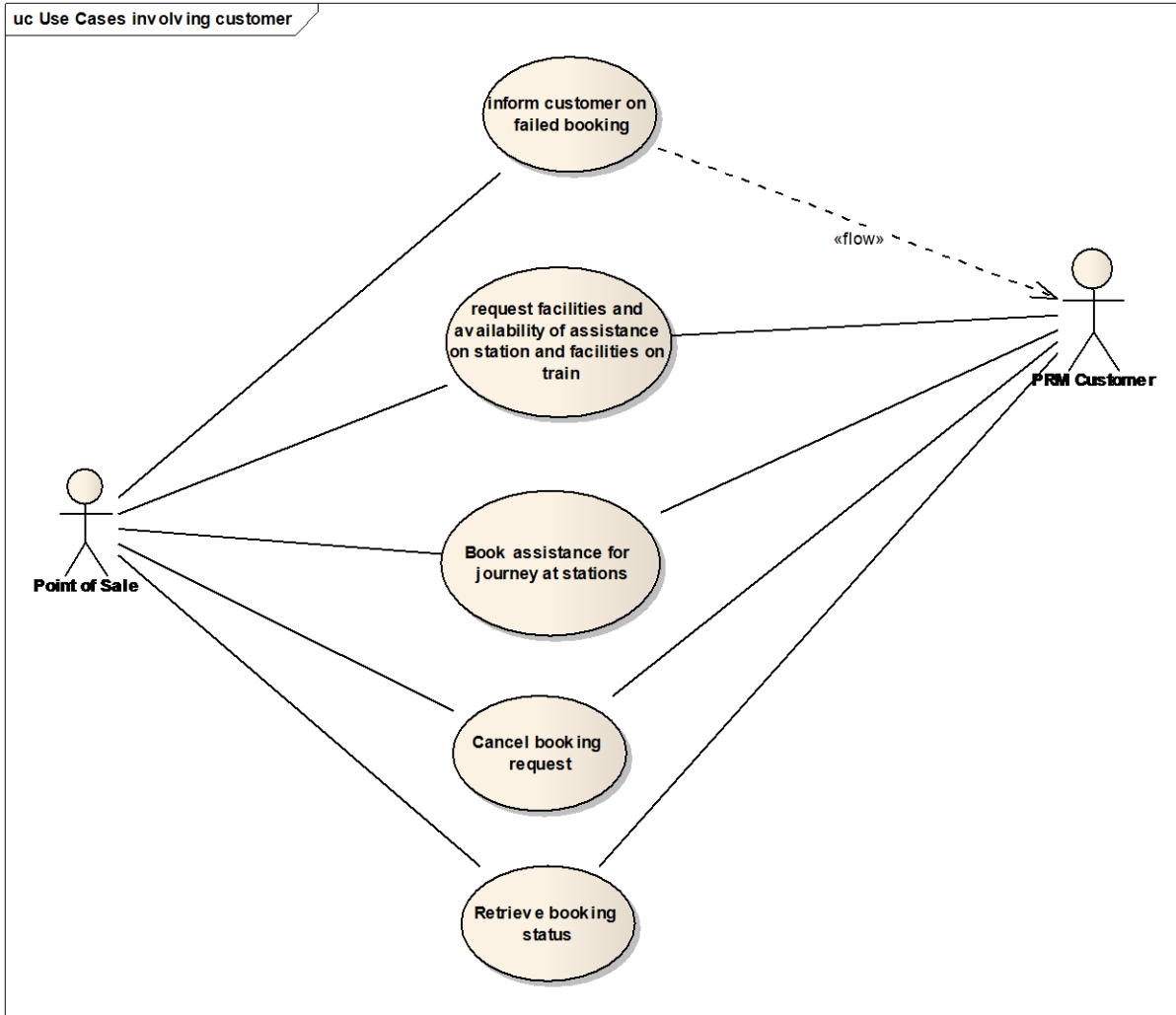

Figure 1 use cases with customers

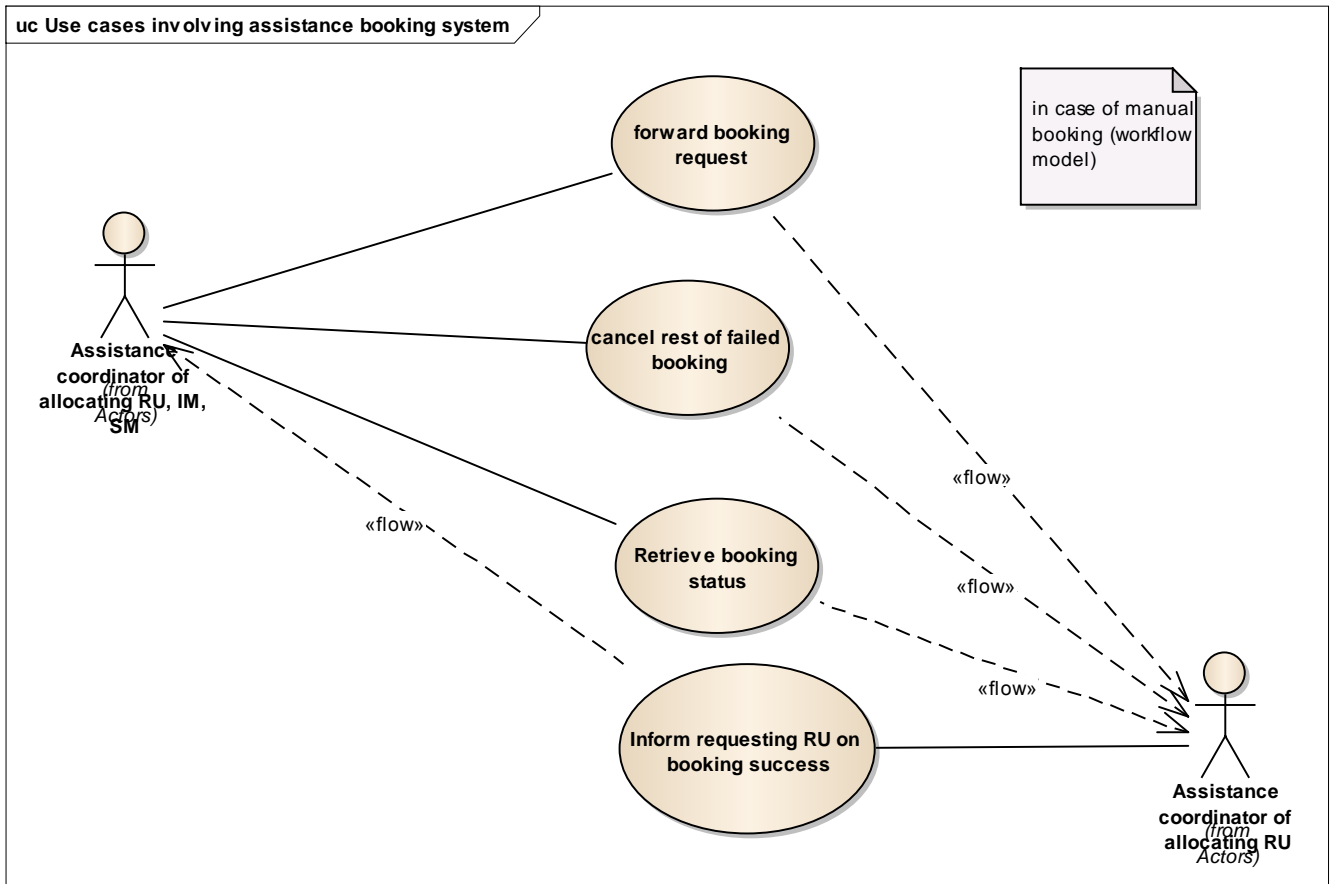

Figure 2 use cases without customer

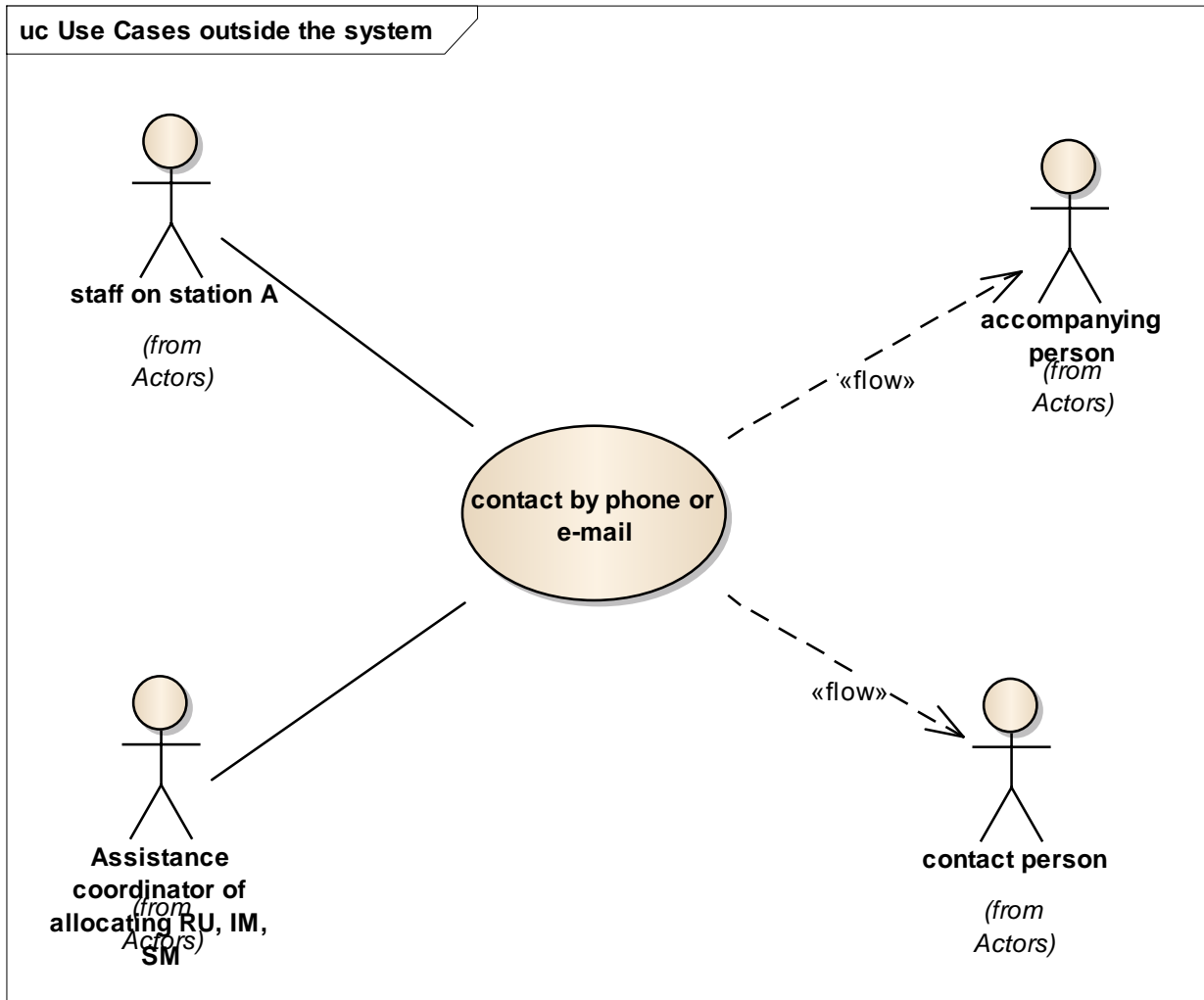

Figure 3 use case “contact customer” (outside the system)

6 Structural model for PRM booking standard

6.1 Definition of data model

Data Entity	Description
Address	General address definition
Assistance	Assistance provided to a PRM at a particular station and time
Booking	Reference to a booking (i.e. the booking of the assistance itself or a travel ticket or a PNR)
Customer	Any type of involved person
Handicap	Type of a handicap
HandicappedCard	Handicapped card of a PRM. The model contains only the type of the card, not the individual number.

European Railway Agency

ERA/TD/2010-01/INT: ANNEX B.10 of TAP TSI

LocalFacility	Type of a facility provided at a station or on a platform
OnBoardFacility	Type of a facility provided on board of a train for a PRM.
Platform	Platform described by its number and the tracks on both sides.
PRM	The person with reduced mobility
PrmBookingSystem	System to provide booking functions
Station	Identification of the station, where the assistance is required.
Tools	Mobile Tools for a PRM either carried by the PRM or provided by a station.
Train	Identification and description of a train.
Train stop	Connecting entity between train station and travel date and time

Table 4 Data Entities

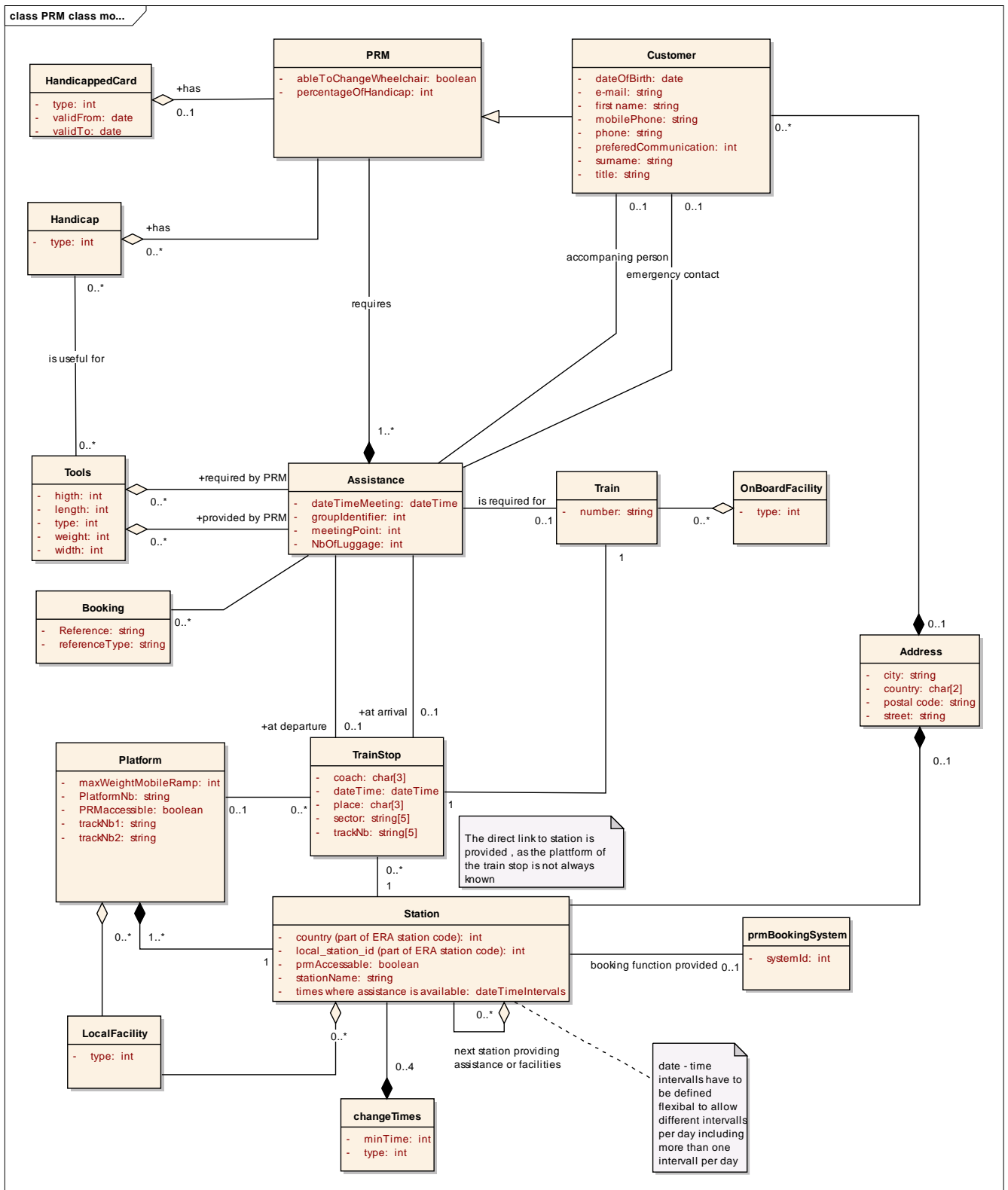

Figure 4 object diagram

6.2 Entity „Address“

The entity defines an address.

Attributes:

- Country
- City
- Postal code
- street

This entity is part of the passenger data catalogue.

6.3 Entity „Assistance“

The entity “Assistance” defines the assistance to be provided to a PRM at a given Place and time.

Assistance is linked to train stop(s) at the station where the assistance has to be provided.

The attributes of the assistance specify the situation of the assistance:

- Meeting point
- Meeting Date and Time
- Number of luggage of the PRM
- Group Identification (to identify PRM traveling in a group)

Via associations the following information is available:

- Tools provided by the PRM
- Tools required by the PRM
- Reference to booking data of the journey
- Arriving Train Stop
- Departure Train Stop
- Accompanying person
- Emergency contact

6.4 Entity „Booking“

The entity booking provides links to bookings with a booking type and a booking reference.

6.5 Entity „Customer“

Customer identifies and describes a Customer.

- Data to identify and contact the customer
- Languages the customer speaks
- Preferred communication channel

Phone numbers have to be given according to the ITU-T E.164 including the international area code.

This entity is part of the passenger data catalogue.

6.6 Entity „Handicap“

The entity provides a list of Handicaps. Codes are according to ERA Code List B.10.4.

6.7 Entity „HandicappedCard”

The entity provides handicapped card data. The card id is not included.

Attributes:

- Valid from
- Valid until
- Percentage of handicap

6.6 Entity „LocalFacility“

The entity provides a code list of facilities provided at stations and platforms. Codes are according to ERA Code List B.10.5.

6.9 Entity „OnBoardFacility“

The entity provides a code list of facilities provided on board of a train. Codes are according to ERA Code List B.10.6.

6.10 Entity „Platform“

The entity platform identifies and describes a platform at a station.

- Is it accessible for PRMs?
- Maximum weight for the mobile ramp (if available)
- Track number of track 1
- Track number of track 2

Via associations the following information is available:

- Local Facilities

This entity is part of the passenger data catalogue.

6.11 Entity „PRM“

More detailed customer description for PRMs. Including:

- percentageOfHandicap
- ability to change a wheelchair

Via associations the following information is available:

- HandicappedCard (Type only)
- Handicap
- requested assistance

6.12 Entity „PrmBookingSystem“

Identification of the booking system providing the booking functions for a station.

The system must be registered in ERA Code List B.10.1, the unique system code is provided there.

6.13 Entity „Station“

“Station” identifies a station by the Station code described in ERA TAP TSI Technical Document B.9. The station provides the following attributes relevant for PRM:

- PRM accessible
- Time range during which assistance is provided (e.g. Mo – Fr 9:00 – 18:00)

Via associations the following information is available:

- Available facilities
- Minimum change time without tool and without platform change
- Minimum change time without tool and with platform change
- Minimum change time with tool and without platform change
- Minimum change time with tool and with platform change
- Platforms of the station

This entity is part of the passenger data catalogue.

6.14 Entity „Tools“

“Tools” provides a code list for mobile facilities either carried by the PRM or to be provided by the station. Codes are according to ERA Code Lists B.10.2.

6.15 Entity „Train“

The entity train identifies and describes a train.

In the PRM system the identification of a train is done via the parameters:

- Station
- Date of the stop
- Train number (external 5 position number)

This identification was chosen, as it is required to identify a train by attributes known and meaningful to the customer.

Via associations the following information is available:

- On board facilities

6.16 Entity „Train stop“

The Entity describes the Stop of a Train at a Station/Platform.

Describing the exact platform is relevant for the assistance booking, as the platform determines the tools available at the station (e.g. not all platforms have elevators). Changing a platform also requires more time in a train change.

- Date and time of the stop
- Track number (optional, can be given in the reply message to the customer)
- Sector of the track
- Coach number of coach used to enter or leave the train at the stop
- Place number the customer wants to enter or leave at the stop

Via associations the following information is available:

- Train (train number only, which identifies the train together with the date and station)
- Platform

This entity is part of the passenger data catalogue.

6.17 Definition of code lists

- 6.17.1 Booking Type : see ERA code list B.10.1
- 6.17.2 Facilities for Assistance: see ERA code list B.10..2
- 6.17.3 Meeting points: see ERA code list B.10.3
- 6.17.4 Disability: see ERA code list B.10.4
- 6.17.5 LocalFacility: see ERA code list B.10.5
- 6.17.6 OnBoardFacility: see ERA code list B.10.6
- 6.17.7 Reply Codes: see ERA code list B.10.7

7 Functional model for PRM booking standard

The functional model describes the scenarios for a fully synchronous distributed system (synchronous model) as well as for distributed systems including manual steps (workflow model) for coordinating the assistance and for a centralized workflow system. The synchronous implementation requires less but more complex functions.

Implementing a mixture would be possible, but would require the combined set of functions.

The following scenarios describe the sequence of the processes from customer on one side till the station staff on the other side to give a full view on the logic. The standardization itself applies only to the functions / messages used between systems of different RUs. Only for these functions the messages used are given in the function calls by their TAG names from the XML schema files. The other functions are due to local implementations.

There are sequence diagrams given for pure synchronous and for pure asynchronous implementation. Combining a mixture of both is not shown, as it does not add additional information.

Sequence Diagrams	Description
Availability and booking (synchronous)	Simple sequence of availability request and booking with systems implementing the direct booking (synchronous)
Cancellation	Cancel a booking or a booking request. As the cancel request does not need manual checks, it can be processed synchronous in all implementations.
Error scenario with lost communication	Error scenario in case of a lost communication. The scenario applies to synchronous as well as to asynchronous implementation.
Manual booking	Booking in case of an asynchronous implementation. The availability request before booking would be the same as in the availability-and-booking scenario, so it was omitted here to keep the diagram small. The availability reply would provide less information, as it would only give some general information on the facilities of the station.
Manual booking with failure	Booking in case of an asynchronous implementation where one of the stations cannot provide the assistance. The availability reply would provide less information, as it would only give some general information on the facilities of the station.

Table 5 sequence diagrams

7.1 Availability and Booking without failure

This sequence diagram describes the behavior in an environment using online booking systems without intermediate manual steps.

The customer starts with an availability request which is split in the booking system of the requesting RU or ticket vendor and forwarded to the systems responsible for the stations. The replies are combined by the booking system of the requesting RU railway to be given to the customer.

The customer starts the booking request. The booking system of the requesting RU or requesting ticket vendor splits the request and sends the request to the systems responsible for the stations. The replies are combined by the booking system of the requesting railway to be given to the customer.

The message standard covers the communication between the booking system of the requesting RU or ticket vendor and the systems responsible for the stations.

The sequence for displaying the availability will be the same in implementations with manual booking procedures, except that the information given will be less accurate.

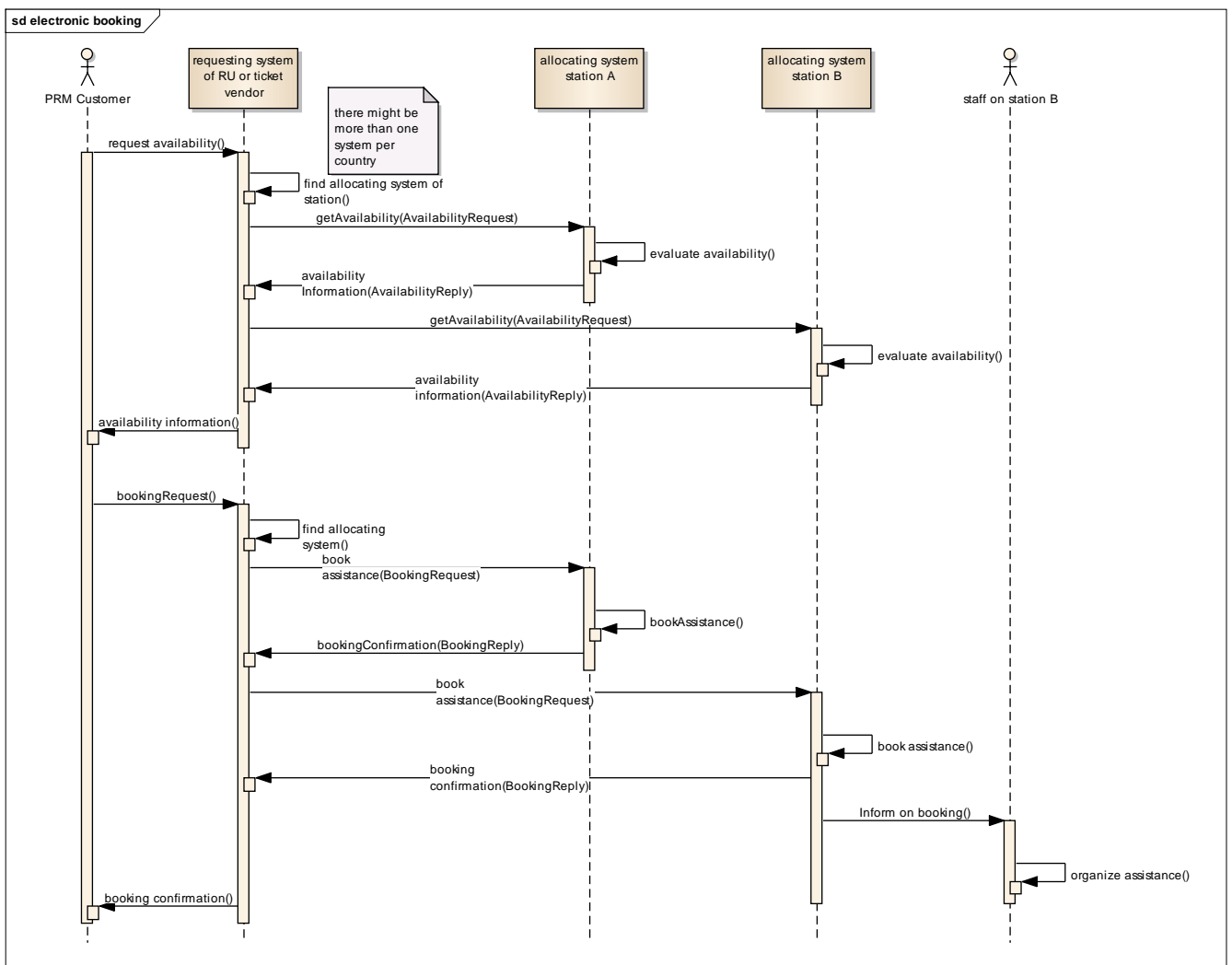

Figure 5 sequence diagram - availability and booking

7.2 Cancellation

The customer cancels a booking or a booking request. A booking request can be cancelled in case of manual booking procedures where the booking reply does not contain a confirmation. The requesting system splits the request and sends the parts to the system responsible for the stations. The sequence is identical for online systems and for systems with manual reservation procedures. A customer can cancel the booking only at the requesting system. The message standard covers the communication between the booking system of the requesting RU or ticket vendor and the systems responsible for the stations.

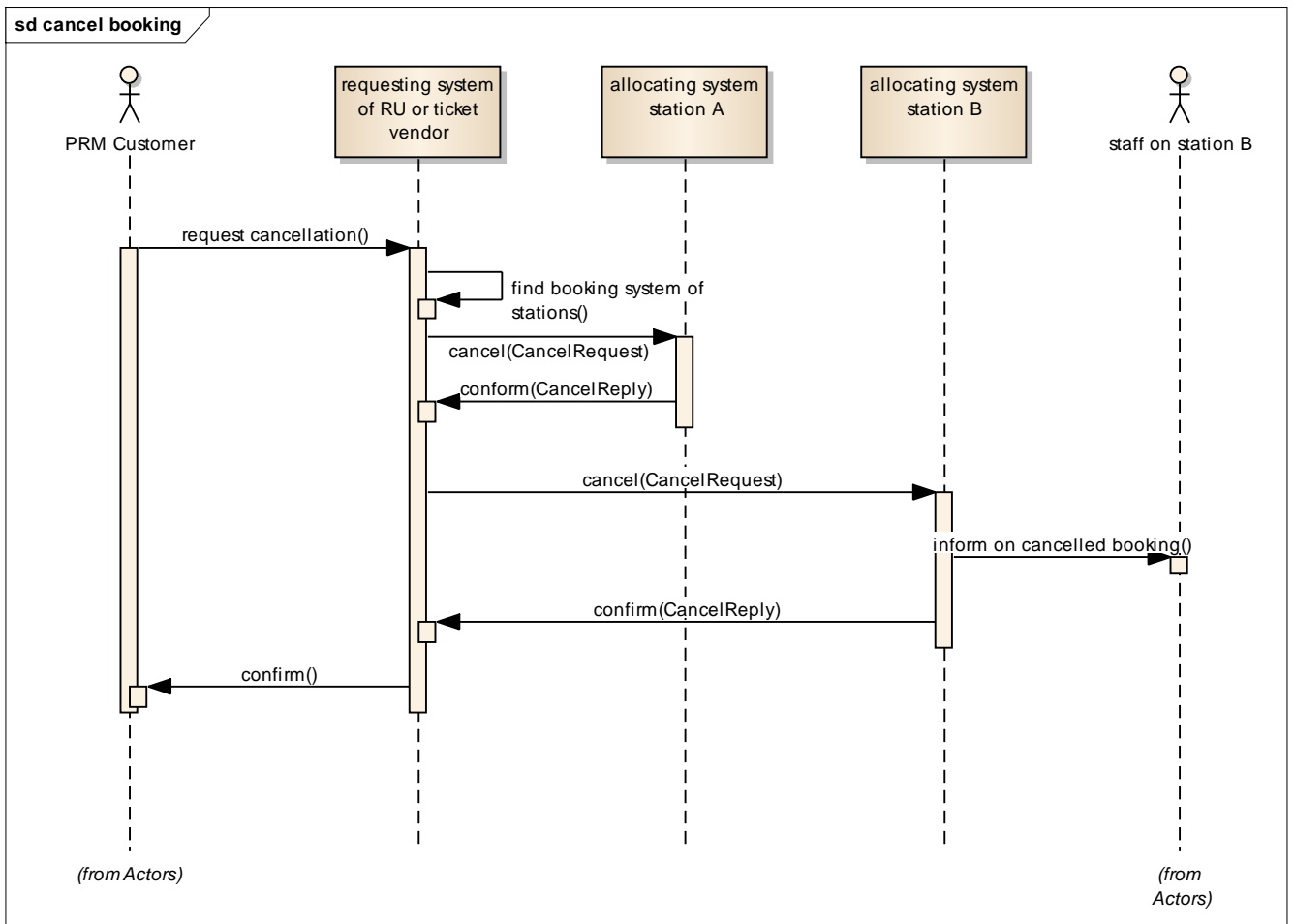

Figure 6 sequence diagram - cancellation

7.3 Error scenario – lost communication

In case of a communication problem the situation after the time out error is unknown. The failure might be inside the booking system of the station or on the communication to or from the booking system of the station.

The requesting system has to resynchronize with the booking system of the station to clear the situation. After clearing the situation by the synchronization dialogue, the requesting system can retrieve the booking data from the “retrieve booking” request.

The message standard covers the communication between the booking system of the requesting RU or ticket vendor and the systems responsible for the stations.

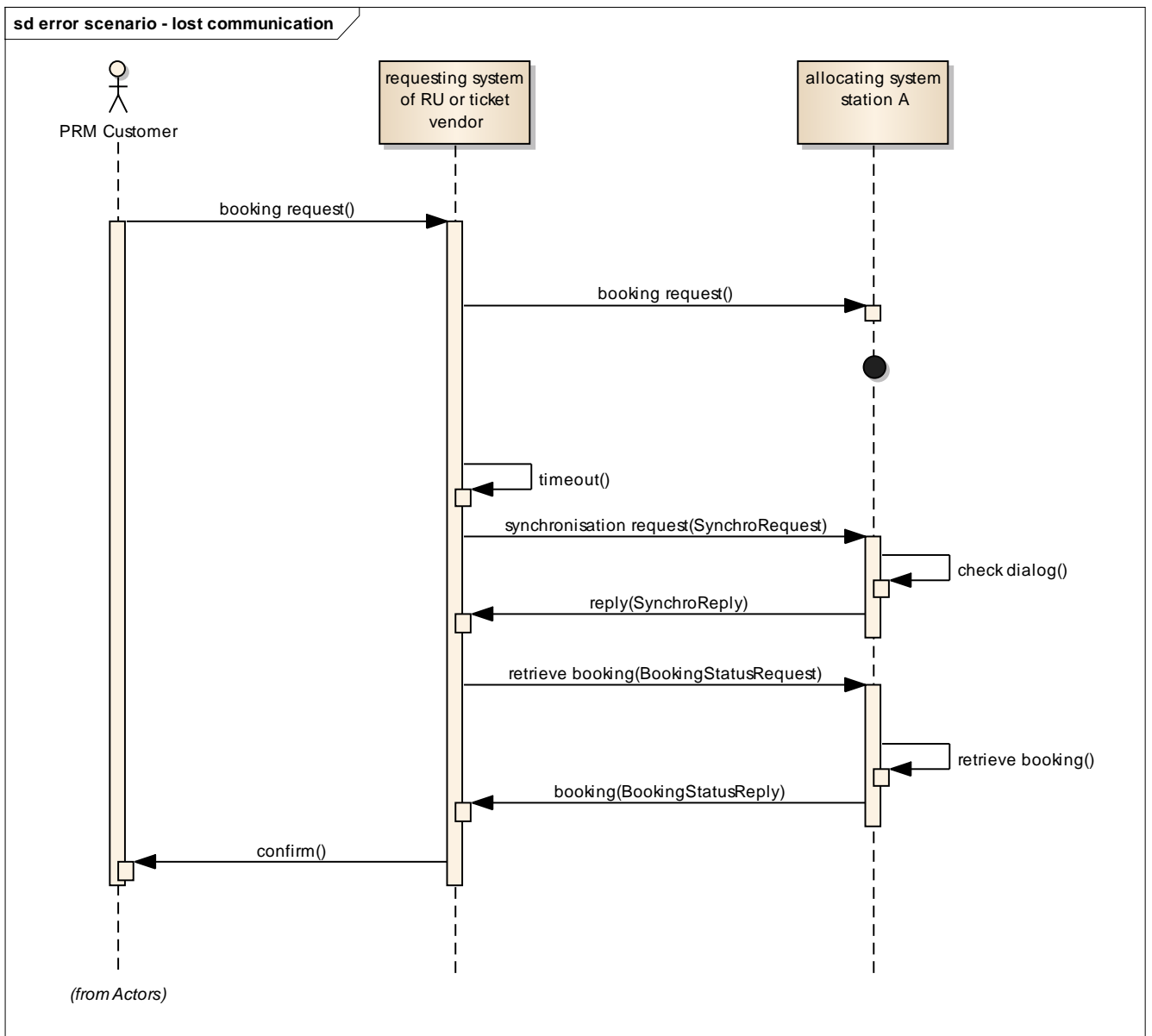

Figure 7 sequence diagram – error handling

7.4 Manual Booking without failure

This scenario includes systems with manual booking procedures. As the availability request is identical to the request in the online scenario only the booking function is detailed here.

There are two additional actors, the coordinator of the requesting RU and the coordinator responsible for the booking of assistance on the stations. To complete the scenario description also the staff at the station is included.

The message standard covers the communication between the booking system of the requesting RU or ticket vendor and the systems responsible for the stations.

As there are manual steps included the process flow (thick vertical bars) are interrupted and continue after a manual interaction only (i.e. the station coordinator manually checks the booking requests and manually confirms the assistance in the system).

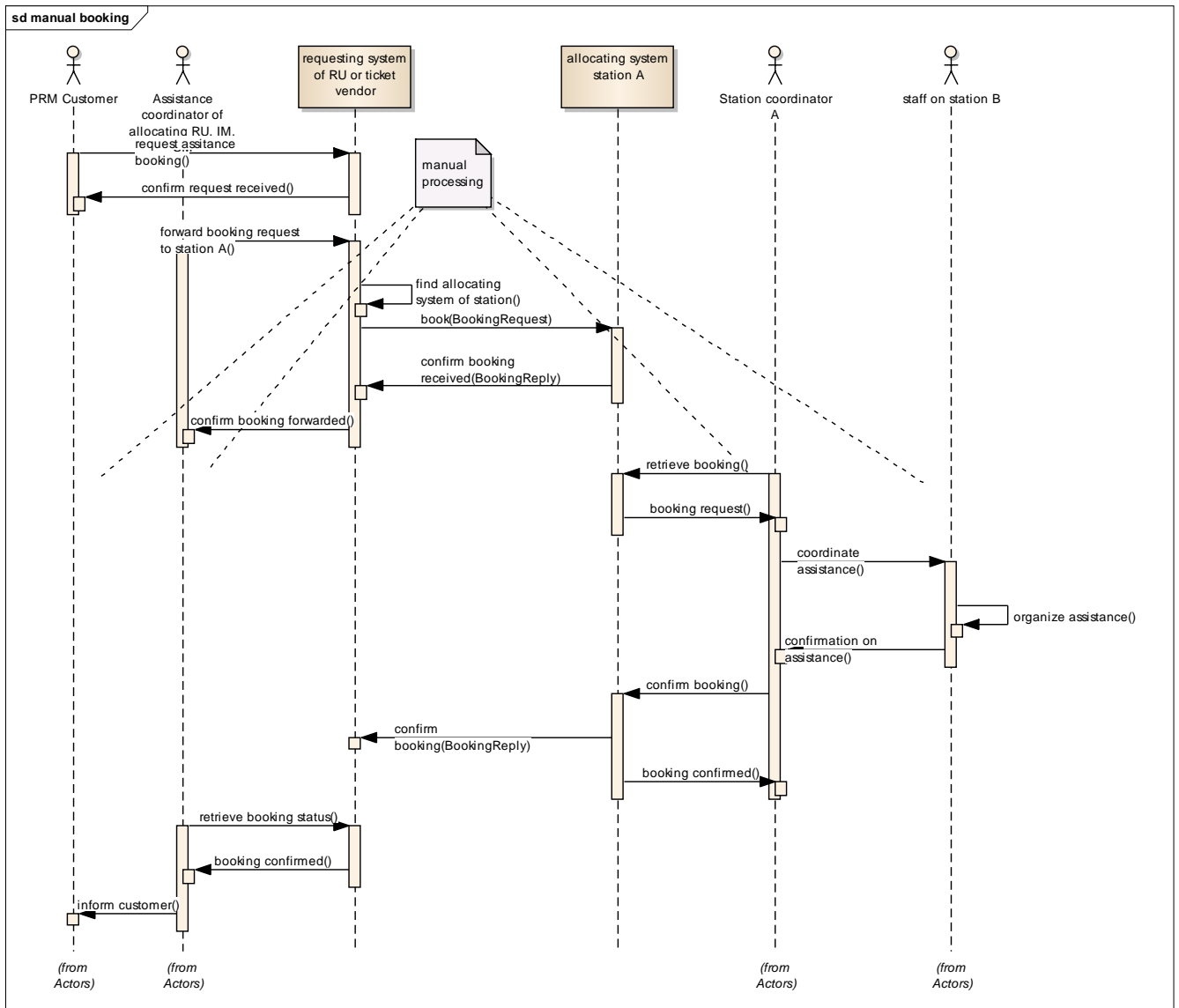

Figure 8 sequence diagram – manual booking

7.5 Manual Booking with failure

This scenario includes systems with failed manual booking procedures. As the availability request is identical to the request in the online scenario only the booking function is detailed here.

The message standard covers the communication between the booking system of the requesting RU or ticket vendor and the systems responsible for the stations.

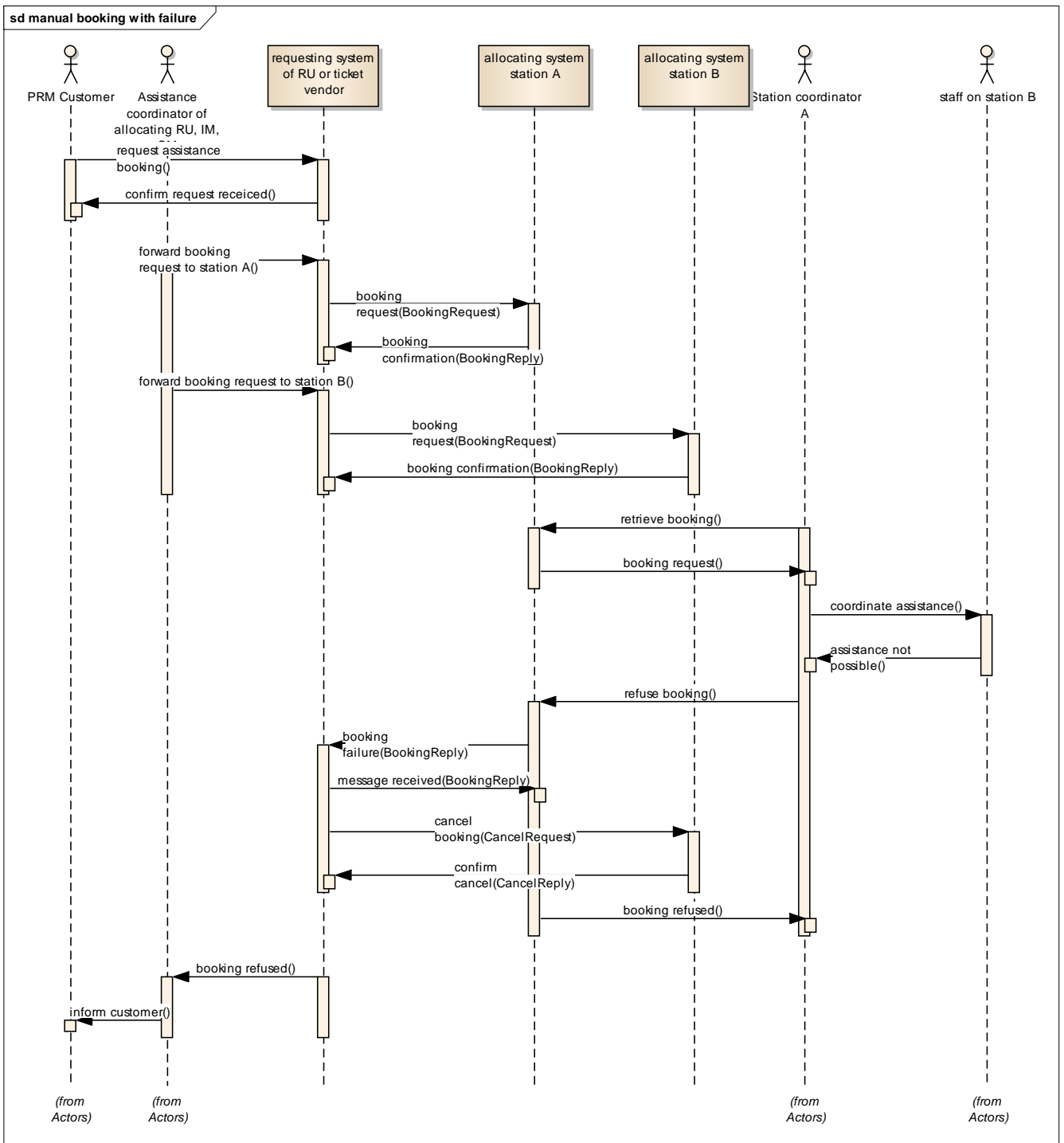

Figure 9 sequence diagram – manual booking with failure

7.6 Request status

The customer should be able to retrieve the actual status of his booking. This scenario is identical in the workflow model and the synchronous booking scenario.

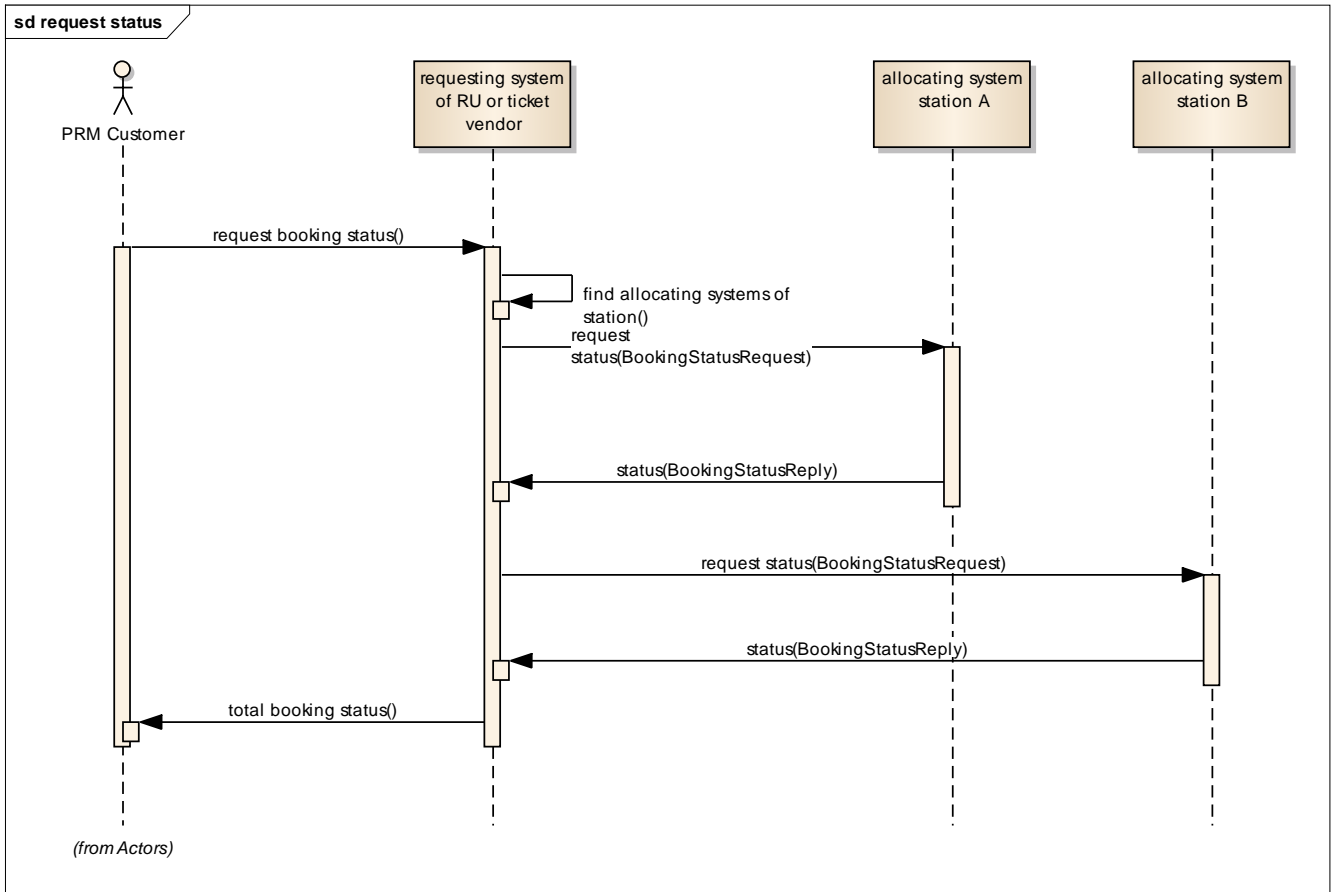

Figure 10 sequence diagram – request status for information

8 XML message specification

8.1 XML message specification basics

8.1.1 Foundations

The specification tries to fulfill the following requirements:

- Defining XML messages according to the best practice standard for XML
- Reuse of type definitions from the XML passenger type catalogue for all data items not specific to PRM booking messages.

8.1.2 Name spaces

The specific definitions are located in the namespace <http://www.era.europa.eu/schemes/TAPTSL>. Note, that the namespace is a virtual address in the ERA web area, which does not necessarily lead to the real specification.

The specification is versioned. The major version number is indicated by the last section of the namespace.

8.1.3 Character Sets

The character set to be used is ISO-8859-1.

8.2 XML specification documents

The specification is provided by schema files (xsd files).

For the convenience of the user, generated documentation files are provided additionally in word format, pdf format and html format. These documentation files are generated and do not contain any additional information. The relevant master documents for implementing an interface based on this specification are the schema files only.

The generated document files contain the complete documentation of the imported catalogues, regardless whether a type definition of the catalogue is used or not.

8.2.1 Schema files

The schema file is organized as follows: The file contains all messages and data types for them in a self-contained xsd-file.

Message Definitions:

- TAP TSI B.10_v1.3.xsd

8.4 Referenced documentation files

- Imported passenger schemas are included in html and pdf documentation.

8.5 XML Versioning

Versions are classified into major releases and minor releases. Major releases get a higher version number in the name space, minor releases keep the version number in the name space and are only accompanied by release notes.

Major releases must be published in the following cases:

- New elements
- New attributes
- Changed multiplicity of elements
- Changed format of elements or attributes (except if only type names are changed)

Minor releases must be published in all other cases of changes in the schema e.g.:

- Additional values in enumeration
- Changed versions of imported schemas if the changes in the imported schema does not affect the messages
- Additional comments
- Changes of type names

Each version must be accompanied by a release note explaining the changes made compared to the previous version.

8.6 XML Versions

8.6.1 Version 1.1.0

Version 1.1.0 is the initial version, so no release note on changes is given.

8.6.1 Version 1.2

- Introduction of BookingReplyId in BookingRequest, BookingReply and BookingStatusRequest
- Introduction of ExternalBookingReference in BookingReply

8.6.1 Version 1.3

- version number in the namespace
- MeetingPointType replaced by MeetingPointTypeCodeList
- all code lists are based on xs:nonNegativeInteger

8.7 Recommendations for XML implementation

Implementation of changes:

New elements and attributes will in general be implemented within two steps. In a first step each system must accept the new elements in received messages. In the second step the elements must be sent and processed by each system.

An implementation of this interface should therefore include mechanisms to support the first step of implementation without software changes.

Implementation of syntax and semantic checks:

It is recommended to implement checks on the syntax of messages generally within the interface and implement checks on the semantics (checks on codes defined in enumeration) in the application, if the error messages generated by the application are more detailed.

9 Abbreviations

Abbreviation	Description
IM	Infrastructure Manager
PRM	Person with reduced mobility
PRR	Passenger Rights Regulation
RU	Railway Undertaking
SM	Station Manager
TV	Ticket vendor
UML	Unified Modeling Language
XML	Extensible Markup Language
XSD	XML Schema Definition

10 Referenced documents

[1] ITU-T E.164 : Assigned Country Codes

[2] ISO-8859-1 : Information technology — 8-bit single-byte coded graphic character sets — Part 1: Latin alphabet No. 1

