

## ERTMS UNIT

### ASSIGNMENT OF VALUES TO ETCS VARIABLES

<b>Reference:</b> ERA_ERTMS_040001	<b>Document type:</b> Technical
<b>Version :</b> 1.38	
<b>Date :</b> 22/12/25	

**ERA ERTMS UNIT**

**ASSIGNMENT OF VALUES TO ETCS VARIABLES**

**AMENDMENT RECORD**

<b>Version</b>	<b>Date</b>	<b>Section number</b>	<b>Modification/description</b>	<b>Author(s)</b>
1.0	17/02/10		Creation of file	E. LEPAILLEUR
1.1	26/02/10		Update of values	E. LEPAILLEUR
1.2	28/06/10		Update of values	E. LEPAILLEUR
1.3	24/01/11		Use of new template, scope and application field, description of the procedure, update of values	E. LEPAILLEUR
1.4	08/04/11		Update of values, inclusion of procedure, request form and statistics, frozen lists for variables identified as baseline dependent	E. LEPAILLEUR
1.5	11/08/11		Update of title and assignment of values to NID_ENGINE, update of url in annex A.	E. LEPAILLEUR
1.6	17/11/11		Update of values	E. LEPAILLEUR
1.7	15/03/12		New assignment of values to various variables	E. LEPAILLEUR
1.8	03/05/12		Update of values	E. LEPAILLEUR
1.9	10/07/12		Update of values, see detailed history of assignments in A.2	E. LEPAILLEUR
1.10	08/10/12		Update of values, see detailed history of assignments in A.2	A. HOUGARDY
1.11	20/12/12		Update of values, see detailed history of assignments in A.2 Update of the contact address of the request form in A.4	O. GEMINE A. HOUGARDY
1.12	22/03/13		Update of values, see detailed history of assignments in A.2	O. GEMINE A. HOUGARDY
1.13	19/06/14		Update of values, see detailed history of assignments in A.2	O. GEMINE A. HOUGARDY
1.14	04/08/14		Update of values, see detailed history of assignments in A.2	O. GEMINE
1.15	17/11/14		Update of values, see detailed history of assignments in A.2	O. GEMINE A. HOUGARDY
1.16	16/01/15		Update of values, see detailed history of assignments in A.2	O. GEMINE A. HOUGARDY
1.17	04/08/15		Update of values, see detailed history of assignments in A.2	O. GEMINE A. HOUGARDY
1.18	18/11/15		Update of values, see detailed history of assignments in A.2	A. HOUGARDY
1.19	29/03/16		Update of values, see detailed history of assignments in A.2	A. HOUGARDY
1.20	14/06/16		Update of values, see detailed history of assignments in A.2	A. HOUGARDY

## ERA ERTMS UNIT

### ASSIGNMENT OF VALUES TO ETCS VARIABLES

Version	Date	Section number	Modification/description	Author(s)
1.21	18/10/16		Update of values, see detailed history of assignments in A.2	O. GEMINE A. HOUGARDY
1.22	26/05/17		Update of values, see detailed history of assignments in A.2	A. HOUGARDY
1.23	13/09/17		Update of values, see detailed history of assignments in A.2	A. HOUGARDY
1.24	31/01/18		Update of values, see detailed history of assignments in A.2	A. HOUGARDY
1.25	29/05/18		Update of values, see detailed history of assignments in A.2	A. HOUGARDY
1.26	14/12/18		Update of values, see detailed history of assignments in A.2	A. HOUGARDY
1.27	21/06/19		Update of values, see detailed history of assignments in A.2	A. HOUGARDY
1.28	12/12/19		Update of values, see detailed history of assignments in A.2	A. HOUGARDY
1.29	03/08/20		Update of values, see detailed history of assignments in A.2	A. HOUGARDY
1.30	22/02/21		Update of values, see detailed history of assignments in A.2	A. HOUGARDY
1.31	20/10/21		Update of values, see detailed history of assignments in A.2	A. HOUGARDY
1.32	12/05/22		Update of values, see detailed history of assignments in A.2	A. HOUGARDY
1.33	24/02/23		Update of values, see detailed history of assignments in A.2	A. HOUGARDY
1.34	25/09/23		Update of values, see detailed history of assignments in A.2	A. HOUGARDY
1.35	25/06/24		Update of values, see detailed history of assignments in A.2	A. HOUGARDY
1.36	17/12/24		Update of values, see detailed history of assignments in A.2	A. HOUGARDY
1.37	27/06/25		Update of values, see detailed history of assignments in A.2	A. HOUGARDY
1.38	22/12/25		Update of values, see detailed history of assignments in A.2	A. HOUGARDY

**TABLE OF CONTENTS**

<b>AMENDMENT RECORD</b>	<b>2</b>
Table of contents	4
<b>1. INTRODUCTION</b>	<b>5</b>
1.1. Foreword	5
1.2. Scope & field of application	5
1.3. Document description	6
<b>2. REFERENCES, TERMS AND ABBREVIATIONS</b>	<b>8</b>
2.1. Reference documents	8
<b>3. LIST OF ASSIGNED VALUES</b>	<b>9</b>
3.1. NID_C: Identity number of the country or region	9
3.2. NID_ENGINE: On-board ETCS [equipment] identity	16
3.3. NID_NTC: National system identity	29
3.4. NID_XUSER: Identity of user system [identity of User Design Authority]	32
3.5. Intentionally deleted	34
3.6. NID_CTRACTION: Identity of the traction system	34
3.7. Intentionally deleted	35
3.8. Intentionally deleted	35
<b>ANNEXES</b>	<b>36</b>
<b>A.1 Procedure for the assignment of the values</b>	<b>36</b>
A.1.1 Definition of requesting organisations	36
A.1.2 Request Procedure	36
A.1.3 Workflow	36
<b>A.2 Detailed history of assignments</b>	<b>39</b>
<b>A.3 Statistics about the use of the variables</b>	<b>57</b>
<b>A.4 Request Form for the assignment of values</b>	<b>58</b>
<b>A.5 Specific additional Form(s)</b>	<b>60</b>
A.5.1 NID_CTRACTION	60
A.5.1.1 Extract from the Infrastructure Interoperability Register	61
<b>A.6 Frozen lists of values</b>	<b>63</b>
A.6.1 M_TRACTION	63
A.6.2 NC_TRAIN: International Category to which belongs the train	64
A.6.3 Q_TEXT	64
A.6.4 M_LOADINGGAUGE (As part of Train data): load profile	66
<b>A.7 Detailed description of the traction systems defined by NID_CTRACTION</b>	<b>67</b>

## 1. INTRODUCTION

### 1.1. FOREWORD

- 1.1.1. The ETCS system uses its own language to exchange data between the trackside and the on-board assemblies. This language is composed of messages, packets and variables and is fully described in the chapter 7 and 8 of the ETCS SRS [2].
- 1.1.2. Among the whole set of the ETCS variables, some are used to configure the system to allow the proper working of certain functionalities. This configuration is either done on a temporary basis and is subject to changes as for instance when crossing a national border, or is done on a permanent basis.
- 1.1.3. Reason for permanent configuration comes from the need to identify uniquely an ETCS constituent as e.g. an ETCS on-board or to give a unique identity to an intangible data as e.g. the identity of a country, in order to avoid functional or safety impacts.
- 1.1.4. The ETCS variables concerned by a permanent assignment are listed in the document [3]. Giving a permanent value to an ETCS variable is then called '*assignment of values to ETCS variables*'. Some assignments can be managed locally as explained in document [3] but others need international coordination and shall be managed at a centralized level.
- 1.1.5. In its role as system authority [1] for ERTMS, the European Railway Agency is responsible for the assignment of values to ETCS variables that need international coordination.

### 1.2. SCOPE & FIELD OF APPLICATION

- 1.2.1. This document gives the whole list of values that have already been assigned.
- 1.2.2. ETCS is a European project that has been set up by the European Commission. Even if the field of application of ETCS is not strictly limited to the European Union, the legal obligations as stated in the interoperability directives concern only the Member States or legal entities that aim to use ETCS products within the European Union areas.
- 1.2.3. Nevertheless, especially as the use of GSM-R as radio system will make it possible to transmit ERTMS/ETCS information worldwide, it is strongly recommended that any entity not member of the European Union follows the principles defined both in annex A.1 and in document [2] for the assignment of values to the ETCS variables of its own project. On purpose, the Agency will manage the related request and/or keep track of the assigned values. The use, by unauthorized entity, of values already assigned, in or outside the European Union shall not occur.
- 1.2.4. As soon as a value has been assigned to a given variable, it will follow its own life: it can continue to be used as foreseen by the originator of the request, could be removed from a constituent in which it has be programmed or could be programmed in another constituent for the replacement of a defective one. Others situations can exists as for instance the selling of an engine equipped with ETCS from a rolling stock owner to another one. The Agency is not responsible of what happens to an ETCS variable after it has been assigned to a legal entity. The legal entity is fully responsible to any misuse of values for ETCS variables. The legal entity must immediately inform the Agency in case it wishes to release a certain range of values or in case it transfers its own responsibility to any another entity.

**1.3. DOCUMENT DESCRIPTION**

- 1.3.1. Chapter 3 lists the concerned ETCS variables and their related assigned values.
- 1.3.2. All the values in the tables of the chapter 3 are given in decimal.
- 1.3.3. When a line of any table of the chapter 3 is background coloured in white, that means values really used in projects or reservation confirmed through the ERA questionnaire performed by the Agency in 2006. Lines still background coloured in yellow means that the related reservation has never been confirmed even if demanded several times by the Agency. They are temporarily kept in this version of the document but the Agency will release them if not confirmed at short notice.
- 1.3.4. The variables previously referred in sections 3.5 (M\_LOADINGGAUGE), 3.6 (M\_TRACTION), 3.7 (NC\_TRAIN) and 3.8 (Q\_TEXT) do affect the ERTMS/ETCS on-board functionality. They are therefore considered as baseline dependent, which means that from now on they cannot be assigned new values. However the list of their previously assigned values is kept in this document for recording purpose.
- 1.3.4.1 Note: Specific care has to be taken when using the variable M\_TRACTION for the traction system information sent to the train through the packet 39, as defined in baseline 2: the interoperability can neither be guaranteed with on-board compliant with baseline 2 nor with on-board compliant with baseline 3.
- The responsibility for the management of the variable M\_TRACTION and for the use of any of its values as well as for the implementation of the packet 39 is taken over by the Member States.
- In case the backward compatibility versus on-board compliant with baseline 3 is to be ensured, any existing or new trackside implementation operated with M\_VERSION = 1 should use the new ETCS variable NID\_CTRACTION encapsulated in the ad hoc packet with M\_VERSION=1.1.
- For existing lines where the variable M\_TRACTION has been used and where it is intended to continue to operate trains that are only able to interpret the packet 39, it is possible to use both variables NID\_CTRACTION and M\_TRACTION, encapsulated respectively in the new ad hoc packet and in packet 39.
- The assignment of a value for the variable NID\_CTRACTION is managed by the Agency and shall be submitted according to the procedure.
- The needed information to be filled for requesting a value for NID\_CTRACTION is described in the Annex A.5.
- 1.3.5. Annex A.1 describes the procedure for a value assignment starting from the request from a submitting entity to the registration of the final value within this document and the corresponding publication on the Agency web site.
- 1.3.6. Annex A.2 gives some more details about the history of values assignment.
- 1.3.7. Annex A.3 gives charts about the statistics on the use of the values.
- 1.3.8. Annex A.4 gives the template of the form to be addressed to the Agency for submission of request.
- 1.3.9. Annex A.5 lists the detailed information that must be provided for the values assignment of specific variables.
- 1.3.10. Annex A.6 gives the lists of previously assigned values for the variables that have been identified as being baseline dependent.

- 1.3.11. Annex A.7 gives the detailed description of those traction systems which are identified by a NID\_CTRACTION value.

**2. REFERENCES, TERMS AND ABBREVIATIONS****2.1. REFERENCE DOCUMENTS***Table 1 : Reference documents*

<b>Ref. N°</b>	<b>Document Reference</b>	<b>Title</b>	<b>Last Issue</b>
[1]	(EU) 2023/1695	Commission implementing Regulation (EU) 2023/1695 of 10 August 2023 on the technical specification for interoperability relating to the control-command and signalling subsystems of the rail system in the European Union and repealing Regulation (EU) 2016/919	-
[2]	SUBSET-026	ERTMS/ETCS System Requirements Specification	4.0.0
[3]	SUBSET-054	Responsibilities and rules for the assignment of values to ETCS variables	4.0.0



### 3. LIST OF ASSIGNED VALUES

#### 3.1. NID\_C: IDENTITY NUMBER OF THE COUNTRY OR REGION

Values	Country	Lines	Confirmed by
1	UK	Cambrian line	Network Rail
2	UK	Thameslink	Network Rail
3	UK	Great Western	Network Rail
4	UK	Crossrail Central Section	Network Rail
5	UK	Thameslink (non ETCS)	Network Rail
6	UK	East Coast	Network Rail
7 to 25	UK	Reserved	Network Rail
26	UK	ENIF	Network Rail
27 to 50	UK	Reserved	Network Rail
51	Portugal	Northern international corridor – Section: Pampilhosa – Vilar Formoso	Portuguese NSA – IMT
52	Portugal	Southern international corridor – Section: Évora – Caia	Portuguese NSA – IMT
53	Portugal	Cascais Line	Portuguese NSA – IMT
55	Spain	Euskal Trenbide Sarea (ETS)	Euskal Trenbide Sarea (ETS)
56	Luxembourg		Thales
57	Luxembourg		Thales
58	Luxembourg		Thales
59 to 61	Luxembourg	Reserved (CFL)	Thales
62	Luxembourg		Thales
63	Luxembourg	Reserved	
64	Germany	Pilot line SBAR(DB), JH-L	Siemens, CER
65 to 104	Germany	Reserved	CER
105	Germany	S-Bahn Berlin	Siemens, CER
106 to 127	Germany	Reserved	CER
128	France	RFF – HSL East	CER, Ansaldo
129 to 191	France	RFF	CER
251 to	Belgium	Infrabel conventional lines	Infrabel

## ERA ERTMS UNIT

### ASSIGNMENT OF VALUES TO ETCS VARIABLES

Values	Country	Lines	Confirmed by
253			
254	Belgium	Infrabel high speed lines	Infrabel
255	Belgium	Infrabel conventional lines	Infrabel
256	Italy	RFI network (both SCMT and ERTMS)	Alstom, Ansaldo, CER, Thales, Bombardier
257	Italy	RFI network	Alstom, CER, Thales, Bombardier
258 to 288	Italy	Requested for SCMT	Bombardier
289	Italy	RFT (Rete Ferroviaria Toscana)	RFT/RFI
290	Italy	STA (Strutture Trasporto Alto Adige)	STA/RFI
291 to 294	Italy	RFI network	RFI
295	Italy	Circumvesuviana lines	EAV
296	Italy	FSE (Ferrovie del Sud Est)	FSE
322 to 335	Finland	Finnish Transport Agency Lines (Liikennevirasto)	Finnish Transport Agency
336	Romania		Ansaldo
337	Romania	Reserved	
338	Republic of Macedonia	Corridor VIII- line section : Kumanovo-Beljakovce	Macedonian Railways Infrastructure
339	Poland	Pomeranian Metropolitan Railway	Pomorska Kolej Metropolitalna / UTK
340	Poland	Reserved	PKP Polish Railway Lines JSC
341	Poland	Reserved	PKP Polish Railway Lines JSC
342	Poland	Reserved	PKP Polish Railway Lines JSC
343	Poland	Reserved	PKP Polish Railway Lines JSC
344	Denmark	Fjernbane Infrastructure System West	BaneDanmark
345	Denmark	Fjernbane Infrastructure System East	BaneDanmark
346 to 350	Denmark	Private railway lines	BaneDanmark
351	Spain/France	Perpignan-Figueras mixed traffic line	TP FERRO
352	Spain	Madrid – Zaragoza – Barcelona – French Border	ADIF
353	Spain	Zaragoza – Huesca and Barcelona – Figueres	ADIF
354	Spain	La Sagra – Toledo	ADIF
355	Spain	Córdoba – Málaga	ADIF
356	Spain	Reserved	ADIF
357	Spain	Madrid – Valladolid	ADIF
358	Spain	Orense – Santiago	ADIF
359 to 360	Spain	Reserved	ADIF

## ERA ERTMS UNIT

### ASSIGNMENT OF VALUES TO ETCS VARIABLES

Values	Country	Lines	Confirmed by
361	Spain	Madrid – Valencia	ADIF
362 to 363	Spain	Reserved	ADIF
364	Spain	Madrid Cercanías	ADIF
365 to 366	Spain	Reserved	ADIF
367	Spain	Ferrocarriles Generalitat (P44)	Siemens
368	Spain	Reserved	ADIF
369	Spain	Reserved	ADIF
370	Spain	Pilot Line Albacete – Villar de Chincilla	ADIF
371 to 383	Spain	Reserved	ADIF
384	Austria	Wien – Nickelsdor	Siemens, Thales
385	Austria		CER
386 to 390	Austria	Reserved	ÖBB
391	Israel	Reserved	Israel railways Ltd
392	Bulgaria	Plovdiv – Svilengrad, Danube-Bridge 2 Vidin-Calafat ETCS L1 projects	NSA of Bulgaria, Railway Administration Executive Agency
393	Spain	ETCS Lines for FGV	Siemens Rail Automation
400	Serbia	Belgrade Centre (excl.) - Stara Pazova - Novi Sad – Subotica - state border with Hungary - Kelebia (excl.)	Infrastructure of Serbian Railways JSC (IZS)
401	Serbia	Belgrade Centre - Stara Pazova – Šid - state border with Croatia -Tovarnik (excl.)	Infrastructure of Serbian Railways JSC (IZS)
402	Serbia	Belgrade Centre - Junction “G” – Rakovica – Mladenovac – Lapovo – Niš - Preševo - state border with North Macedonia - Tabanovce (excl.)	Infrastructure of Serbian Railways JSC (IZS)
403	Serbia	Niš – Dimitrovgrad - state border with Bulgaria - Dragoman (excl.)	Infrastructure of Serbian Railways JSC (IZS)
404	Serbia	Belgrade Centre (excl.) – Resnik – Požega – Vrbnica - state border with Montenegro - Bijelo Polje (excl.)	Infrastructure of Serbian Railways JSC (IZS)
405	Serbia	Belgrade Marshalling Yard „A“ – Ostružnica - Batajnica and Belgrade Marshalling Yard „A“- Junction “B”- Junction “K/K1” – Resnik	Infrastructure of Serbian Railways JSC (IZS)
406	Serbia	Subotica – Horgos - state border with Hungary - Rösztke (excl.)	Infrastructure of Serbian Railways JSC (IZS)
408	Albania	Railway line Durres – Tirana Public Transport Terminal (PTT) New railway connection to Rinas airport (TIA) Other new railway lines	Albanian Railway
409	Turkey	Eskisehir (Excluding) - Balikesir Line	ALSTOM Transport / TCDD

## ERA ERTMS UNIT

### ASSIGNMENT OF VALUES TO ETCS VARIABLES

Values	Country	Lines	Confirmed by
410	Turkey	Ankara-Istanbul High Speed Line	TCDD
411	Turkey	Marmaray ERTMS project	ALSTOM Transport Belgium
412	Turkey	Mersin – Toprakkale ETCS L1 project	Ansaldo STS / TCDD
413	Turkey	Boğazköprü – Yenice ETCS L1 project	Ansaldo STS / TCDD
414	Turkey	Reserved	Ansaldo STS / TCDD
415	Turkey	Ankara Konya High Speed line.	Invensys / TCDD
416	Hungary	Budapest-Kelenföld (excl.) – Hegyeshalom (Austrian border) line ERTMS/ETCS L1	MÁV
417	Hungary	West-Hungary (Transdanubian part)	MÁV
418	Hungary	East-Hungary	MÁV
419	Hungary	Budapest Area	MÁV
420	Slovakia	ZSR	Slovak Transport authority (Dopravný úrad)
424 to 426	Netherlands	various projects	CER
427	Netherlands	HSL-Zuid	Alstom, Siemens, Thales
428	Netherlands	ProRail connecting line to HSL-Zuid	Siemens, Thales
429 to 431	Netherlands	Reserved	CER
448 To 451	Switzerland	Level 2	Federal Office of Transport
452 to 454	Switzerland	ETCS L1 LS and P44 applications (SIGNUM / ZUB / ZSI 127)	Federal Office of Transport
455	Switzerland	Specific cases at border sections	Federal Office of Transport
456 To 458	Switzerland	Level 2	Federal Office of Transport
459 To 465	Switzerland	Spare	Federal Office of Transport
472	Greece	Athens Suburban Railways lines (ASR)	Alstom
473	Greece	Athens Suburban Railway line Ska – Kyato project	Alstom, Siemens
474	Greece	Pireaus – Athens – Three Bridges	EDISY S.A.
475	Greece	Athens – Thessaloniki – Bulgaria Level 1 corridor	EDISY S.A.
476 to 478	Slovenia	Reserved	AŽP
479	Slovenia	State border-SEŽANA/KOPER-HODOŠ-State border (Corridor D)	SŽ/IM
480 to 489	Slovenia	Reserved	AŽP

## ERA ERTMS UNIT

### ASSIGNMENT OF VALUES TO ETCS VARIABLES

Values	Country	Lines	Confirmed by
501	Croatia	Vinkovci-Tovarnik-state border Okucani-Novska	Ministry of Sea, Transport and Infrastructure
502	Croatia	Reserved	Ministry of Sea, Transport and Infrastructure
503	Croatia	Reserved	Ministry of Sea, Transport and Infrastructure
504	Czech Republic	AZD test line Čížkovice–Obrnice	AZD
510	Kazakhstan	Kazakhstan State Railway lines	Bombardier
511	Kazakhstan	Kandyagash – Nikeltau	Siemens / AO NK "KTZh"
512	Czech Republic	VUZ	CER
513 to 519	Czech Republic	SZDC	SZDC
520 to 529	Norway	Reserved	Norwegian National Railway Administration (Jernbaneverket)
530 to 531	Sweden	Swedish Transport Administration lines (Trafikverket)	Swedish Transport Agency (Transportstyrelsen)
532 to 535	Sweden	Reserved	Swedish Transport Agency (Transportstyrelsen)
540	Australia	New South Wales network ETCS Level 1	RailCorp
541	Australia	Reserved	RailCorp
542	Australia	Reserved	RailCorp
543	Australia	Reserved	RailCorp
544	Australia	Reserved	RailCorp
545	Australia	Reserved	RailCorp
546	Australia	Seaford line, Belair line and Gawler line	Department of Planning, Transport & Infrastructure (DPTI) South Australia
547	Australia	Qld North Coast Line L1	Queensland Rail
548	Australia	Reserved	Queensland Rail
549	Australia	Reserved	Queensland Rail
550	Kazakhstan	Zhetygen – Korgas line ETCS Level 1	Ansaldo – STS
551	Kazakhstan	Reserved	Ansaldo – STS
552	Kazakhstan	Reserved	Ansaldo – STS
553	Kazakhstan	Reserved	Ansaldo – STS
554	China	HS line Zhengzhou-Xi'an Railway Passenger Dedicated Line (ETCS Level 2)	Ansaldo – STS
555	Mongolia	Trans-Mongolian railway corridor	Bombardier
570	Russia	ITARUS project, ATC TRIAL SITE Khosta – Matsesta, ETCS Level 2	Ansaldo – STS
571	Russia	Reserved	Ansaldo – STS
572	Russia	Reserved	Ansaldo – STS
573	Russia	Reserved	Ansaldo – STS

## ERA ERTMS UNIT

### ASSIGNMENT OF VALUES TO ETCS VARIABLES

Values	Country	Lines	Confirmed by
580 to 599	Canada	GO Network/Reserved	Metrolinx
600	New Zealand	ETCS Level 1 system for the Auckland Metropolitan Rail Network	New Zealand Railways Corporation (KiwiRail)
617	Australia	Capital Project 00204	Siemens/Aurizon
700	Libya	Coastal Line ETCS level 1 and level 2	Ansaldo – STS
701	Libya	South Line ETCS level 2	Ansaldo – STS
702	Libya	Reserved	Ansaldo – STS
703	Libya	Reserved	Ansaldo – STS
704	Egypt	Electric Express Train (High Speed Rail)	Siemens Mobility GmbH
705	Egypt	Reserved (Level 2 High Speed Rail)	Siemens Mobility GmbH
706	Egypt	Level 1 Projects	Siemens Mobility GmbH
707	Egypt	Level 1 Projects with ZUB	Siemens Mobility GmbH
800	Algeria	Algeria: Rocade Nord	Thales
801	Algeria	Reserved	Thales
802	Algeria	Reserved	Thales
803	Algeria	Reserved	Thales
804	Algeria	Reserved	Thales
805	Senegal	TER Dakar	Ministère des Infrastructures, des Transports et du Désenclavement du Sénégal (MITTD)
806 to 807	India	Delhi – Ghaziabad – Meerut RRTS Corridor of NCRTC	National Capital Region Transport Corporation
808	Republic of Tanzania	Dar Es Salaam – Morogoro – Makutupora Standard Gauge Railway (SGR).	Tanzania Railway Corporation
809	Ethiopia	Awash-Kombolcha-Haragebeya (AKH) Railway Project	Ethiopian Railway Corporation
810	Morocco	ETCS level 1 line Rabat-Casablanca	Thales
811 to 819	Morocco	Reserved	Thales
820 and 821	South Africa	Gauteng region	PRASA
822	South Africa	Kwa-Zulu natal region	PRASA
823	South Africa	Western cape region	PRASA
830 to 850	Thailand	SRT - ETCS	Thales on behalf of State Railway of Thailand
870	UAE	Hafeet Rail Line between UAE and Oman	Siemens on behalf of Hafeet Rail
871	Oman	Hafeet Rail Line between UAE and Oman	Siemens on behalf of Hafeet Rail
880	Saudi Arabia	Makkah-Madinah, Haramain High Speed Railway	Siemens / SRO
882	UAE	Network of up to 1,200 km stretching across the Emirates	Etihad Rail
883	Saudi Arabia	NSR	Thales
884	Saudi Arabia	NSR	Thales
885	Saudi Arabia	Dammam-Riyadh	Siemens

## ERA ERTMS UNIT

### ASSIGNMENT OF VALUES TO ETCS VARIABLES

Values	Country	Lines	Confirmed by
886	Taiwan	Taiwan Railway Administration	Bombardier
887	Korea	Korean National Railroad KNR	Bombardier
888	China	Reserved	Siemens
889	China	Line Wuhan-Guangzhou	Bombardier
900	India	Indian Railways	Ansaldo
901	Malaysia	Malaysian Railways	Bombardier
902	Republic of the Philippines	Manila - LRT Line 1 Cavite Extension	Alstom/LRTA
903	Republic of the Philippines	Greater Manila Area - North-South Commuter Railway (NSCR) - N1 section (Malolos-Tutuban)	Department of Transportation (DOTr), Philippines
904	Republic of the Philippines	North-South Commuter Railway Extension (NSCR-EX)	Alstom Transport India Limited
918 to 919	Mexico	Tren Maya Mexico line	Fondo Nacional de Fomento al Turismo - FONATUR
920	Mexico	Line Mexico-Toluca	Thales on behalf of Secretaria de Comunicaciones y Transportes
921	Mexico	Transit line Buenavista-Cuautitlán	Thales Rail Signalling Solution, S.L.U.
922	Chile	Line Santiago-Rancagua	EFE
930 to 935	Brazil	Project "Supervia" to equip the rail commuter network of Rio de Janeiro (Brazil) with ERTMS.	Bombardier – Rail Control Solutions (RCS)
936	Uruguay	Ferrocarril central del Uruguay	Dirección Nacional de Transporte Ferroviario, Ministerio de Transporte y Obras Públicas
940	Indonesia	LRT Palembang	Siemens, DGR
941 to 950	Indonesia	Reserved	Siemens, DGR
951 to 960	Poland	Reserved	PKP Polskie Linie Kolejowe S.A.
961	Poland	HSR Lines	Centralny Port Komunikacyjny sp. z o. o. (CPK)
1022 to 1023	Ireland	Iarnród Éireann network	Iarnród Éireann (Irish Rail)

## ERA ERTMS UNIT

### ASSIGNMENT OF VALUES TO ETCS VARIABLES

#### 3.2. NID\_ENGINE: ON-BOARD ETCS [EQUIPMENT] IDENTITY

Values	Information on rolling stock fleet/on-board equipment supplier	Confirmed by
0 to 1023	Bombardier RCS	Bombardier
1024 to 1199	FS: Reserved	FS
1200 to 1399	FS / Assigned Ansaldo	FS
1400 to 3024	FS: Reserved	FS
3025 to 3042	Renfe / Assigned: Alstom – S-100	Renfe
3043 to 3060	Renfe / Reserved	Renfe
3061 to 3072	Renfe / Assigned: Alstom – S-100	Renfe
3073 to 3099	Renfe / Reserved	Renfe
3100 to 3131	Renfe / Assigned: Siemens – S-102	Renfe
3132 to 3199	Renfe / Reserved	Renfe
3200 to 3259	Renfe / Assigned: Siemens – S-112	Renfe
3260 to 3299	Renfe / Reserved	Renfe
3300 to 3331	Renfe / Assigned: Siemens – S-103	Renfe
3332 to 3351	Renfe / Assigned: Siemens – S-103	Renfe
3352 to 3399	Renfe / Reserved	Renfe
3400 To 3411	Renfe / Assigned: Ansaldo – S-120	Renfe
3412 to 3449	Renfe / Reserved	Renfe
3450 to 3465	Renfe / Assigned: Ansaldo – S-120.050	Renfe



## ERA ERTMS UNIT

### ASSIGNMENT OF VALUES TO ETCS VARIABLES

Values	Information on rolling stock fleet/on-board equipment supplier	Confirmed by
3466 to 3499	Renfe / Reserved	Renfe
3500 to 3539	Renfe / Assigned: Alstom - S-104	Renfe
3540 to 3599	Renfe / Reserved	Renfe
3600 to 3625	Renfe / Assigned: Alstom - S-114	Renfe
3626 to 3699	Renfe / Reserved	Renfe
3700 to 3728	Renfe / Assigned: Ansaldo - S-121	Renfe
3729 to 3799	Renfe / Reserved	Renfe
3800 to 3889	Renfe / Assigned: Bombardier - S-130 / S-730 (12 of 6 S130 train with Siemens equipment)	Renfe
3890 to 4999	Renfe / Reserved	Renfe
5000 to 6999	Alstom	Alstom
7000 to 11999	Switzerland	SBB
12000 to 12199	Lloyd's Register Rail Europe B.V. For Class'66 and G1206 loco's retrofitting	Lloyd's Register Rail Europe B.V.
12200 to 12699	Hitachi	Hitachi Rail Europe
12700 to 12719	ADIF ETCS trains	ADIF
12720 to 12919	Hitachi - India	Hitachi Rail Europe
12920 to 12929	Trafikverket rolling stock	Hitachi Rail STS Sweden
12930 to 12939	Infranord rolling stock / Hitachi Rail STS	Hitachi Rail STS Sweden
12940 to 12959	Rescue train "RTZ" for Österreichische Rail Equipment GmbH & Co KG, with the ETCS on- Board Product Trainguard 200 from Siemens Mobility GmbH	Stadler Signalling AG
12960 to 12965	Stadler SMILE EC250 for WESTbahn with Trainguard 200	Stadler Bussnang AG

## ERA ERTMS UNIT

### ASSIGNMENT OF VALUES TO ETCS VARIABLES

Values	Information on rolling stock fleet/on-board equipment supplier	Confirmed by
12966 to 12999	Eurostar e320 Velaro Siemens	Eurostar international Limited
13000 to 14999	Alstom	Alstom
15000 to 15999	UK	Ansaldo
16000 to 16120	Ansaldo Breda: Reserved	Ansaldo Breda
16121 to 16999	Slovenia	SŽ/RU
17000 to 17050	NV Infrabel: Reserved	Infrabel
17051 to 20550	Bombardier	Bombardier
20551 to 20566	Austrian Private Railways – ES64U4 / Trainguard 200: STLB (Steiermärkische Landesbahnen) WLC (Wiener Lokalbahnen) LTE / ADRIA (LTE Logistik- und Transport-GmbH / ADRIA Transport) CARGOSERV (Cargo Service GmbH )	Siemens
20567 to 20568	Vossloh Locomotives / Trainguard 200	Siemens
20569 to 20570	Skoda locomotive 109 E – ZSR locomotive 381 (Slovak railway)	Siemens
20571 to 20573	AngelStar ETCS-OBU retrofit prototypes for DB	Stadler Bussnang AG
20574 to 20576	Stadler Flirt ADIF diagnostic train	Stadler Signalling AG
20580 to 20585	CFR Locomotives 477 / Trainguard 200	Siemens
20586 to 20595	Haramain Rescue Locomotives – Trainguard 200 OBU	Siemens
20596 to 20599	Stadler Flirt FGC Lleida Rodalies	Stadler Signalling AG
20600 to 20699	Bombardier reserved values for “EFE project “ (Santiago de Chile, Chile)	Bombardier – Rail Control Solutions (RCS)
20700 to 20949	UK DesiroCity ETCS / Trainguard 200	Siemens
20950 to 20989	ETR610 (ED250) Pendolino	PKP Intercity S.A.

## ERA ERTMS UNIT

### ASSIGNMENT OF VALUES TO ETCS VARIABLES

Values	Information on rolling stock fleet/on-board equipment supplier	Confirmed by
20990 to 20997	Stadler KISS EMU 6 cars ZSSK with Siemens Trainguard 200	Stadler Polska Sp. z o.o.
21000 to 21499	Bombardier reserved values for "Supervia project" (Rio de Janeiro, Brazil)	Bombardier – Rail Control Solutions (RCS)
21500 to 21999	Euroloco PH37Aci project. (Belgium, Luxembourg, Netherlands, Germany)	General Electric Transportation
30001 to 32000	Project AM08 (305 engines) Migration to ETCS for 450 existing engines	SNCB / NMBS
32001 to 32500	Siemens Vectron Locomotives / Trainguard 200: Reserved	Siemens
32501 to 32550	Eurosprinter Locomotives ES64U4 / Trainguard 200: Austrian Private Railways PKP-IC Poland Slovenian Railway Company	Siemens
32551 to 32565	Stadler FLIRT NRH / Trainguard 200	Siemens
32566 to 32625	PESA 43WE « Dart » (ED161) PKP-IC Poland PESA 218Mc (SA133) PKM PESA 219M (SA136) PKM	PESA Bydgoszcz SA
32626 to 32665	EMU ED160 series (type FLIRT3 L-4292)	PKP Intercity S.A
32666 to 32736	Flirt with Angelstar On-board System (Project Koleje Mazowieckie)	Stadler Polska
32737 to 32760	Flirt with Angelstar On-board System (Project PKP IC II)	Stadler Polska
32761 to 32780	Stadler FLIRT LKA / Trainguard 200	Stadler Polska Sp. z o.o.
32781 to 32796	Stadler Mermec AngelStar RFI Diagnostic Train	Stadler Signalling AG
32800 to 32849	ProRail ESC lab testing activities	ProRail
32850 to 32899	Siemens Desiro City trains / Govia Thameslink Railway (GTR) / Trainguard 200 UK Moorgate Branch	Siemens
32900 to 32999	Newag Impuls vehicles / Trainguard 200	Siemens
33000 to 33999	Auriga OBS: Netherlands - Sprinter New Generation – Civity CAF UK - Arriva Rail North – Civity CAF México – Toluca - Secretaria de Comunicaciones y Transporte de México (SCT)	CAF
34000 to 34299	<ul style="list-style-type: none"> <li>• E494 TRAXX DC3 Locomotives built by Bombardier Transportation Italy to be delivered to Mercitalia Rail and other private companies</li> <li>• Yellow Machines for track maintenance already installed with national Class B Italian system to</li> </ul>	ECM S.p.A.

## ERA ERTMS UNIT

### ASSIGNMENT OF VALUES TO ETCS VARIABLES

Values	Information on rolling stock fleet/on-board equipment supplier	Confirmed by
	be upgraded with class A system for Rete Ferroviaria Italiana. <ul style="list-style-type: none"> <li>• New purchasing of Yellow Machines for track maintenance installed with class A+B systems to be bought in the next years by Rete Ferroviaria Italiana.</li> <li>• E405 Locomotives built by Bombardier Transportation already installed with national Class B Italian system to be upgraded also with class A system for Mercitalia Rail upgrading project</li> <li>• E412 Locomotives built by Bombardier Transportation already installed with national Class B Italian system to be upgraded also with class A system for Mercitalia Rail upgrading project</li> </ul>	
34300 to 34399	HRI Caravaggio EMUs / Ansaldo STS	Ansaldo STS
34400 to 34599	Siemens Trainguard 200 Stadler Flirt MAV & Flirt3 GySEV	Siemens Mobility GmbH
34600 to 34649	Siemens Trainguard 200 Rheintal Desiro & Mireo	Siemens Mobility GmbH
34650 to 34769	Class 43 retrofit project	Thales Germany
34770 to 34869	German Rail Companies / Trainguard 200	Siemens Mobility GmbH
34870 to 34889	JSC "Serbia Train" / Trainguard 200	JSC "Serbia Train"
34890	ČD VUZ Skoda 124.601-6	Thales Austria
34891	Raaberbahn AG, Ventus Trains with Trainguard 200 OBU	Raab-Oedenburg-Ebenfurter Eisenbahn AG
34892 to 34899	DB Regio Franken-Südthüringen / Siemens Trainguard 200	Siemens Mobility GmbH
34900 to 34999	Newag EMU Impuls 2, electric locomotives Dragon E6 and Griffin E4 / Trainguard 200 OBU	Siemens Mobility GmbH
35000 to 35099	Desiro HC Israel Railways / Siemens Trainguard 200	Siemens Mobility GmbH
35100 to 35219	German Rail, Siemens High Speed Trains with Trainguard 200	Siemens Mobility GmbH
35220 to 35359	German Rail, Siemens High Speed Trains Velaro Multisystem BR408 with Trainguard 200	Siemens Mobility GmbH
35360 to 35459	Newag EMU Impuls 2, electric locomotives Dragon E6 and Griffin E4 / Trainguard 200 OBU	Siemens Mobility GmbH
35460 to 35499	TGV S-108/S-109	OUIGO España

## ERA ERTMS UNIT

### ASSIGNMENT OF VALUES TO ETCS VARIABLES

Values	Information on rolling stock fleet/on-board equipment supplier	Confirmed by
35500 to 35599	VZES ILSA Rolling Stock	Hitachi Rail STS
35600 to 35699	Thales Qishuyan Project - CDA5B1 Locomotive	Thales Austria GmbH
35700 to 35799	Hitachi Rail STS SpA for UAE	Hitachi Rail STS SpA
35800 to 35824	Trainguard 200 OBU on electrical multiple units EJ660/661	BETAMONT s.r.o.
35825 to 35934	ETCS Retrofit project for LINEAS locomotives HLD77	The Signalling Company
35935 to 35984	Nordic Re-Finance railway locomotives	Hitachi Rail STS Sweden
35985 to 36184	ÖBB Yellow Fleet with Siemens Trainguard 200 OBU	Siemens Mobility GmbH
36185 to 36384	LEMA - Softronic with ETCS OB	Softronic
36385 to 36884	Iarnród Éireann (Irish Rail) retrofitment and new fleets	Iarnród Éireann (Irish Rail)
36885 to 36925	Trainguard 200 OBU on Loco Class 130 ČD Cargo, a.s.	ŽOS Vrútky, a.s.
36926 to 36975	Network Rail Heritage and Charter vehicles	Thales UK
36976 to 37165	Single Deck Hybrid Multiple Unit (HMU) for Trenitalia	Hitachi Rail STS
37166 to 37225	Upgrade to ERTMS B2 of E414 fleet for Trenitalia	Hitachi Rail STS
37226 to 37385	High Capacity Double Deck EMU Train for Trenitalia	Hitachi Rail STS
37386 to 37585	High Capacity Double Deck EMU for Trenord	Hitachi Rail STS
37586 to 38585	Auriga ETCS Onboard Unit	CAF Signalling
38586 to 38615	Tågakeriet i Bergslagen AB (Tågab)	Hitachi Rail STS Sweden
38616 to 38636	Trainguard 200 OBU on Loco Class 361 Železničná spoločnosť Slovensko, a.s	ŽOS Vrútky, a.s.
38637 to 38736	ADIF Rolling Stock	ADIF

## ERA ERTMS UNIT

### ASSIGNMENT OF VALUES TO ETCS VARIABLES

Values	Information on rolling stock fleet/on-board equipment supplier	Confirmed by
38737 to 38761	ETCS OBS STM	Medway, Operador Ferroviário de Mercadorias S.A
38762 to 38781	Single Deck Hybrid Multiple Unit (HMU) for Trenitalia	Hitachi Rail STS
38782 to 39221	High Capacity Double Deck EMU Train for Trenitalia	Hitachi Rail STS
39222 to 39250	Trainguard 200 OBU on Loco Class 240 ČD Cargo	ŽOS Vrútky, a.s.
39251 to 39300	0916E EAV NAPOLI - AUTOMATIC TRAIN PROTECTION SYSTEM	Hitachi Rail STS
39301 to 39330	Trainguard 200 OBU on Loco 363.5 CD Cargo	CD Telematika a.s.
39331 to 39349	Eurostar e300	Eurostar International Limited
39350 to 39499	VZI6 Full Hitachi for Trenitalia	Hitachi Rail STS
39500 to 39549	STADLER – MEDWAY PROJECT	Hitachi Rail, GTS Deutschland GmbH
39550 to 39558	Stadler FLIRT NRE (Germany) with the ETCS On-Board Product Guardia from Angelstar	Stadler Signalling AG
39559	Raaberbahn AG, Ventus Trains with Trainguard 200 OBU	Raab-Oedenburg-Ebenfurter Eisenbahn AG
39560 to 39659	Trainguard 200 OBU on vehicles Newag EMU Impuls 2, electric locomotives Dragon E6 and Griffin E4	Siemens Mobility GmbH
39660 to 39719	German Rail, Siemens High Speed Trains Velaro Multisystem BR408 with Trainguard 200	Siemens Mobility GmbH
39720 to 39899	NS Retrofit VIRM / Siemens Trainguard 200	Siemens Mobility GmbH
39900 to 39999	Newag Griffin multi system Locomotives E4MSUa	Siemens Mobility GmbH
40000 to 40499	Siemens Trainguard 200 Mireo	Siemens Mobility GmbH
40500 to 40999	Siemens Vectron / Trainguard 200 OBU	Siemens Mobility GmbH
41000 to 41099	Velaro EMU for Egypt High Speed Railways / Siemens Trainguard 200	Siemens Mobility GmbH
41100 to 41199	Desiro HC EMU for Egypt High Speed Railways / Siemens Trainguard 200	Siemens Mobility GmbH

## ERA ERTMS UNIT

### ASSIGNMENT OF VALUES TO ETCS VARIABLES

Values	Information on rolling stock fleet/on-board equipment supplier	Confirmed by
41200 to 41299	Desiro HC Israel Railways / Siemens Trainguard 200	Siemens Mobility GmbH
41300 to 41399	Vossloh DM20 locomotives / Siemens Trainguard 200	Siemens Mobility GmbH
41400 to 41515	ATR 220 TR SWING of TRENITALIA (vehicle fleet is related to the types ATR 220 Tr NFB and ATR 220 TR NFB-4)	ANGELSTAR Srl
41516 to 41590	Project VDV Tram Train, operator AVG (Germany)	Stadler Signalling AG
41591 to 41620	Project VDV Tram Train, operator RSBNA (Germany)	Stadler Signalling AG
41621 to 41640	Project VDV Tram Train, operator SOÖ (Austria)	Stadler Signalling AG
41641 to 41660	Project VDV Tram Train, operator Schiene Salzburg (Austria)	Stadler Signalling AG
41661 to 41687	Project SZU Flirt (Switzerland) with the ETCS on-board Product Guardia from Angelstar	Stadler Signalling AG
41688 to 41709	ETCS OBS for Speno International Yellow Fleet OTMs	Hitachi Rail GTS Austria GmbH
41710 to 41729	Trainguard 200 OBU on electrical multiple units EJ660/661	DOPSYS s.r.o.
41730 to 41739	Desiro HC Isar-Noris-Altmühl / Siemens Trainguard 200	Siemens Mobility GmbH
41740 to 41749	Desiro HC Netz Werdenfels / Siemens Trainguard 200	Siemens Mobility GmbH
41750 to 41766	Trainguard 200 OBU for Loco Class CFR483	Siemens Mobility, s. r. o.
41770 to 41829	Project Stadler ETCS ERFIT FLIRT NS (Netherlands) with the ETCS On-Board Product Guardia from Angelstar	Stadler Signalling AG
41830 to 41849	0916E EAV NAPOLI - AUTOMATIC TRAIN PROTECTION SYSTEM – SECOND BATCH	Hitachi Rail STS
41850 to 41900	Siemens Desiro UK Eversholt UK Rails Group Class 185 / Siemens Trainguard 200	Siemens Mobility GmbH
41901 to 42000	Thailand OBS	Hitachi Rail GTS Austria

## ERA ERTMS UNIT

### ASSIGNMENT OF VALUES TO ETCS VARIABLES

Values	Information on rolling stock fleet/on-board equipment supplier	Confirmed by
42001 to 42080	AngelStar ETCS-OBU retrofit of DB Netz vehicles for track and catenary maintenance	Stadler Wallisellen AG
42081 to 42180	Wabtec diesel locomotives ES30ACi / Siemens Trainguard 100 OBU	Siemens Mobility GmbH
42181 to 42430	WINDHOFF MPV® VentuS® (Trainguard® 200 OBU)	Siemens Mobility GmbH
42431 to 42500	Flirt with Hitachi Rail STS On-board System for VR	Stadler Polska Sp. z o.o.
42501 to 42550	Manila NSCRCP04 fleet	Hitachi Rail STS
42551 to 42600	HARSCO project	Hitachi Rail, GTS Deutschland GmbH
42601 to 42800	Deutsche Bahn	Hitachi Rail, GTS Deutschland GmbH
42801 to 42900	Trainguard 200 OBU on vehicles Newag EMU Impuls 2, electric locomotives Dragon E6 and Griffin E4	Siemens Mobility GmbH
43001 to 43035	S900 Euskotren vehicles – Trainguard 100	Siemens Rail Automation
43036 to 43050	TD2000 Euskotren locomotives – Trainguard 100	Siemens Rail Automation
43051 to 43060	RGX, RGC and C44 Builds/Retro-fittings	Loram UK
43061 to 43168	S-Bahn Hamburg - Retrofitting of trains with Siemens Trainguard 200	Siemens Mobility GmbH
43169 to 43179	Trainguard 200 OBU on vehicles EMU Flirt3XL L-4613	Siemens Mobility GmbH
43180 to 43184	EET Yellow Fleet	Siemens Mobility GmbH
43200 to 43249	STADLER – MEDWAY PROJECT	Hitachi Rail , GTS Deutschland GmbH
43250 to 43299	CRRC AZ Loco S-Bahn Berlin Project	Hitachi Rail , GTS Deutschland GmbH
43300 to 43339	Trainguard 200 OBU on Loco CL242 (91 54 7 242 xxx - x) ČD Cargo	ČD - Telematika a.s.
43340 to 43439	Siemens Trainguard 100 S4300 FGV	Siemens Rail Automation
90000 to 90999	Ankara-Konya High Speed Line Project, Ankara-Istanbul High Speed Line Project, Ankara-Izmir High Speed Line Project, Ankara-Sivas High Speed Line Project.	TCDD



## ERA ERTMS UNIT

### ASSIGNMENT OF VALUES TO ETCS VARIABLES

Values	Information on rolling stock fleet/on-board equipment supplier	Confirmed by
91000 to 91049	Cumaovasi-Tepekoy vehicles – Trainguard 200	Siemens
91050 to 91099	Bandirma vehicles / Trainguard Futur 3000	Siemens
91100 to 91119	Marmaray Auxiliary vehicles – Trainguard Futur 3000	Siemens
91120 to 91149	Samsun-Kalin vehicles – Trainguard 100	Siemens
91150 to 91199	Banedanmark / Reserved	Banedanmark
91200 to 91349	Red Line Project, Thailand	Thales
91350 to 91519	Austria Rail, Siemens Commuter Trains with Trainguard 200 OBU	Siemens Mobility GmbH
91520 to 91619	ATR803 Stadler Flirt DMU-B / Angelstar Guardia	Stadler Bussnang AG
91640 to 91799	STADLER Dr19 locomotives. VR.	Hitachi Rail STS Sweden
91800 to 91999	SJ rolling stock	Hitachi Rail STS Sweden
92000 to 92019	LRT Palembang vehicles – Trainguard 100	Siemens
92020 to 92762	UK Freight ETCS On-board Project	Siemens Mobility Limited
92763 to 92773	Diagnostic vehicles “MM800 T4 RFI” for Rete Ferroviaria Italiana (RFI)	Angelstar Srl
92774 to 92785	Stadler FLIRT NBS (Netz Berlin Stettin - Germany and Poland) with the ETCS On-Board Product Guardia from Angelstar	Stadler Signalling AG
93000 to 106999	Alstom	Alstom
107000 to 107319	Queensland Rail	Queensland Rail
107350 to 107400	PCW-Wildenrath, ETCS Test IDs	Siemens Mobility GmbH
107401 to 107442	EUROLIGHT DUAL TRENITALIA DE406	Angelstar Srl
107443 to 107449	Project of MERMEC spa for the supply to RFI of multifunction diagnostic vehicles (MM800DC - Semipilota diagnostica) for the detection of rail integrity and defects of gallery	Angelstar Srl

## ERA ERTMS UNIT

### ASSIGNMENT OF VALUES TO ETCS VARIABLES

Values	Information on rolling stock fleet/on-board equipment supplier	Confirmed by
313002 to 313011	Project KISS Double Decker, Slovenia SZ	Stadler Polska Sp. z o.o.
313012 to 313086	Flirt with Angelstar On-board System (Project Koleje Mazowieckie)	Stadler Polska Sp. z o.o.
314001 to 314118	RENFE Gran Capacidad Serie 453 - Stadler	Stadler Signalling AG
315001 to 315020	Stadler Maas Wupper Express Flirt EMU XL (with on-board Product Guardia, supplier AngelStar)	Stadler Signalling AG
510002 to 510022	Project Flirt EMU, Slovenia SZ	Stadler Polska Sp. z o.o.
610002 to 610022	Project Flirt DMU, Slovenia SZ	Stadler Polska Sp. z o.o.
610023 to 610042	Project Flirt DMU2 (option), Slovenia SZ	Stadler Polska Sp. z o.o.
701001 to 701150	Project KISS Double Deck EMU - Transito, Sweden with Ansaldo STS On-board System.	Stadler Altenrhein AG
800001 to 800160	Project KISS MAV, Hungary – Double Deck with Angelstar On-board System	Stadler Altenrhein AG
900001 to 900034	Project Arriva Limburg FLIRT3 EMU Retrofit ETCS (with on-Board Product Guardia, Supplier Angelstar)	Stadler Signalling AG
900035 to 900102	Project Arriva NLL (WINK & GTW) ETCS Retrofit	Stadler Signalling AG
1048576	ČD VUZ	AZD
1048577 to 1048592	ČD : Reserved	
1048593 to 1048596	ČD	CER
1048597 to 1050624	ČD : Reserved	
1116001 to 1116999	ÖBB	ÖBB
1117000 to 1117499	Croatia, Ministry of Sea, Transport and Infrastructure	Croatia, Ministry of Sea, Transport and Infrastructure
1118001 to 1118044	AngelStar ETCS-OBUs of Saudi Arabia Railways new Trainsets for use on the East line linking Riyadh with Dammam	Stadler Signalling AG
1186816	DB/Siemens	Siemens, CER
1186817 to 1186879	DB	CER
1186880 to 1186884	DB/Siemens	Siemens, CER

## ERA ERTMS UNIT

### ASSIGNMENT OF VALUES TO ETCS VARIABLES

Values	Information on rolling stock fleet/on-board equipment supplier	Confirmed by
1186885 to 1188799	DB	CER
1188800 1188801	DB/Siemens	Siemens, CER
1188802 to 1188863	DB	CER
1216001 to 1216999	ÖBB	ÖBB
1217000 to 1217100	Project KISS – WESTBahn ET4010 and ET4110	Stadler Rail Group / Siemens AG CAY management AG on behalf of WESTbahn Management GmbH and Stadler Altenrhein AG
1217101 to 1217150	MRCE Dispolok – ES64U2 / Trainguard 200	MRCE Dispolok GmbH
1269760 to 1270783	DB	CER
2097152 to 2162687	SNCF	CER
2162688	SNCF: Reserved	
3003700 to 3003899	Locomotives EN40AC (3800 and 3700) / Trainguard 200 Capital Project 00204	Siemens
5767683 to 5767711	Siemens	
6062500 to 6062549	Siemens – test vehicles	Siemens
7409016	Siemens	Siemens
7409064	Siemens	Siemens
7409080	Siemens	Siemens
7409662	Siemens	Siemens
8840000 to 8849999	Thales	Thales
8850000 to 8859999	ETCS on-board units for Saudi Arabia Dammam-Riyadh line, e.g. locomotive series SDL50, SDD17 and NR111	Siemens
8860000 to 8860500	ETCS on-board units for Hungarian locomotive project	ZHUZHOU CRRC TIMES ELECTRIC CO., LTD
8860501 to 8861000	ETCS on-board units for Czech trainset project	ZHUZHOU CRRC TIMES ELECTRIC CO., LTD
8861001 to 8862000	ETCS on-board units for Romania trainset project	ZHUZHOU CRRC TIMES ELECTRIC CO., LTD
8862001 to 8864000	ETCS on-board units for trainset project in Africa	ZHUZHOU CRRC TIMES ELECTRIC CO., LTD

**ERA ERTMS UNIT****ASSIGNMENT OF VALUES TO ETCS VARIABLES**

---

<b>Values</b>	<b>Information on rolling stock fleet/on-board equipment supplier</b>	<b>Confirmed by</b>
9960000 to 9960500	ETCS OBUs for Double-decker EMU Project in Austria/Germany/Switzerland/Hungary/Slovakia	CRSC Research & Design Institute Group Co.,Ltd (CRSCD)
9960501 to 9960800	ETCS OBUs for EMU Project in Serbia/Hungary	CRSC Research & Design Institute Group Co.,Ltd (CRSCD)
9960801 to 9960810	ETCS OBUs for Swietelsky Bahnbau AG project of ENCHANTER	CRSC Research & Design Institute Group Co.,Ltd (CRSCD)
9961001 to 9961300	ETCS OBUs for Turkey project.	CRSC Research & Design Institute Group Co., Ltd. (CRSCD)
16776191	TRACK RECORDING CAR (TRC) – Project TRC HZ Infra 9021, Croatia	ANGELSTAR Srl
16776192 to 16777215	DB: for testing only	CER

## ERA ERTMS UNIT

### ASSIGNMENT OF VALUES TO ETCS VARIABLES

#### 3.3. NID\_NTC<sup>1</sup>: NATIONAL SYSTEM IDENTITY

Values	Country	System	Comments	Confirmed by
0	Spain	ASFA	Used in Zaragoza-Huesca ERTMS TRK-L1	Alstom
1	Netherlands	ATB	(The two versions of ATB (EG and NG) can be seen as a group, not to be activated individually. But this number shall also be used by an STM with the EG function only)	Alstom, Siemens, Ansaldo, CER, Bombardier
2	Spain	ASFA AVE		Unisig
3	Spain	LZB Spain (C)	Including ASFA AVE function for conventional lines	Unisig
5	Belgium	TBL 1	Includes Crocodile	Alstom, Siemens, Ansaldo, CER
6	Germany, Austria	PZB 90		Federal Railway Authority Germany (EBA) Austrian Federal Ministry of Transport, Innovation and Technology (BMVIT)
7	Belgium	TBL 2/3	Including crocodile and TBL 1	Alstom, Siemens, Ansaldo, CER
8	France	KVB		Alstom, Ansaldo, CER
9	Germany, Austria, Israel	PZB/LZB	PZB/LZB Classic and LZB CE (national group)	Federal Railway Authority Germany (EBA) Austrian Federal Ministry of Transport, Innovation and Technology (BMVIT)
10	Spain	LZB	Includes ASFA, AVE for high speed lines	Siemens, CER, Thales, Bombardier
11	Italy	SCMT	Used to manage level transitions	Alstom, Ansaldo, CER
12	Luxembourg	MEMOR II+	crocodile based system for Luxembourg	Unisig
14	France, Belgium, UK, China, Korea	TVM		Ansaldo, CER
15	Italy	BACC		Unisig
16	Italy	RSDD		Unisig
17	Hungary	EVM		Thales
18	Belgium	Crocodile		Ansaldo, Siemens, Unisig

<sup>1</sup> « NID NTC » is the new name of the variable formerly referred to as « NID\_STM » in baseline 2.

## ERA ERTMS UNIT

### ASSIGNMENT OF VALUES TO ETCS VARIABLES

Values	Country	System	Comments	Confirmed by
19	Spain	EBICAB 900 TBS	TBS includes ASFA function	Invensys
20	UK	TPWS/AWS	Assumed that both names used for identical systems or can be seen as a group, not to be activated individually	Unisig
21	UK	TPWS/AWS (SA)	Specific application of the TPWS/AWS in Level 2 with trackside signals areas.	Network Rail
22	Norway, Sweden	ATC2	Ebicab 700 (N+S), L10000 (N+S)	Ansaldo, Unisig
23	Finland	EBICAB 900		Unisig
24	Poland	EBICAB 900 (PL)		Unisig
25	Korea	KNR ATS		Bombardier
26	Poland	SHP		Unisig
27	Croatia, Slovenia, Serbia	INDUS I 60		Croatian Ministry of Sea, Transport and Infrastructure Public Agency of the Republic Slovenia for Railway Transport Infrastructure of Serbian Railways JSC (IZS)
28	Belgium	TBL1+		Service public fédéral Mobilité et Transports
29	France	NExTEO	NExTEO project for RER E in Paris	SNCF Réseau
30	Denmark	ZUB 123		Unisig
32	France	RPS	French version of Crocodile	Unisig
33	Czech Republic / Slovakia	LS		Ansaldo, Unisig, CER
34	Portugal	EBICAB 700 (P)	not same system as e.g. Spain and Portugal	Unisig
35	UK	SELCAB	for conventional lines	Unisig
36	Romania	INDUS I 60		Unisig
37	UK	TBL		Unisig
39	Baltic	ALSN	It is also installed in Russian federation and Belarus	Unisig
40	Bulgaria	EBICAB		Unisig
45	China	CTCS-2	Used for the line between cities Wuhan and Guangzhou	Bombardier
46	Malaysia	EBICAB 700	KTMB/Malaysia specific	Bombardier
47	France	KCVP	RER B in Paris	SNCF Réseau
50	UK	TGMT	CBTC system for Elizabeth Line in London	Network Rail
51	Türkiye	NTC-West	Infrastructure required for the operation of STM in western Türkiye	Republic of Türkiye Ministry of Transport and Infrastructure

## ERA ERTMS UNIT

### ASSIGNMENT OF VALUES TO ETCS VARIABLES

---

Values	Country	System	Comments	Confirmed by
52	Türkiye	NTC-East	Infrastructure required for the operation of STM in eastern Turkiye	Republic of Türkiye Ministry of Transport and Infrastructure
255	Reserved for multicast	All	Unisig Subset 035, time and odometer multicast	Alstom, Ansaldo, Unisig

**3.4. NID\_XUSER: IDENTITY OF USER SYSTEM [IDENTITY OF USER DESIGN AUTHORITY]**

Values	User design authority	Confirmed by
1	MMI Direct	
2	SBB, Zub 121 migration in Switzerland Siemens	Alstom, Siemens, CER
3	for ZSI 127 (train control system for narrow gauge applications in Switzerland, Spain), can be on lines with 3 <sup>rd</sup> /4 <sup>th</sup> rail, where ETCS equipped trains pass	Siemens
4	DB-AG	Siemens, CER
5	for pantograph to third rail switching at Rheinbraun Mining Railway in Germany (telegram structure according to SRS 5A)	Siemens
6	RFF Functions	RFF
7	Bombardier Transportation Rail Control Solutions	Bombardier
8	PSD session establishment information for ETCS over GPRS (Denmark)	Danish Transport and Construction Agency
9	RSBB (UK)	RSSB
10	MAV (Hungarian State Railways)	MAV
11	Train borne fire alarm (Netherlands)	
12	RENFE, Used in Zaragoza-Huesca ERTMS TRK-L1, for the Spanish National functions FN-36	Alstom, Ansaldo, Invensys, Siemens, CER
13	SNCB (projects EURO-TBL1 & EURO-TBL2)	Alstom, Ansaldo
14	TRAINGUARD MT – Trainstop	Siemens
15	TRAINGUARD MT – ITC mode	Siemens
16	Door release function for Marmaray ERTMS project	Alstom
17	CBTC balise message embedding for Marmaray ERTMS project	Alstom
18	SŽ/RU Functions	AŽP
20	ÖBB	ÖBB
21	IZS	Infrastructure of Serbian Railways JSC (IZS)
39	Italian Railway FS, used currently in Pkt44 with destination = SCMT NTC	Alstom, Thales, Ansaldo, CER
44	Queensland Rail Packet 44 Applications	Queensland Rail
50	Thales ETCS OBS	Thales Transportation Systems
97	Localisation NExTEO	SNCF Réseau
98	Track conditions for RER and suburban trains in areas operated with level NTC in France	SNCF Réseau
99	Track conditions for national systems in areas not fitted with ETCS in Belgium	Service Public Fédéral Mobilité et Transports
100	Transition Coherence Control	Ansaldo, CER
101	SNCF Functions	Ansaldo, CER
102	NTC Systems Functions	Ansaldo, CER



## ERA ERTMS UNIT

### ASSIGNMENT OF VALUES TO ETCS VARIABLES

103	Automatic Selective Door Operation (ASDO) for Transport for New South Wales (Australia)	Ansaldo STS on behalf of Transport for New South Wales
150	Sweden (Banverket)	Ansaldo, CER
200	Correct Side Door Enable Function for Auckland Metropolitan Rail Network	New Zealand Railways Corporation (KiwiRail)
210	Correct Side Door Enable Function for Department of Planning, Transport and Infrastructure Network	Australia Department of Planning, Transport and Infrastructure (DPTI)
211	Platform Screen Doors in NSCR-EX project, Republic of the Philippines	Alstom Transport India Limited

**3.5. INTENTIONALLY DELETED**

**3.6. NID\_CTRACTION: IDENTITY OF THE TRACTION SYSTEM**

According to the Infrastructure register, a traction system is fully defined by a set of fifteen parameters.

For each assigned value of NID\_CTRACTION as listed in the following table, the values corresponding to the parameters are detailed in the annex A7.

<b>Values</b>	<b>Identification</b>
1	Netherlands, 1.5kV DC
2	Netherlands, conventional lines, 25kV AC 50Hz
3	Netherlands, high speed lines, 25kV AC 50Hz
4	Switzerland, 15kV AC 16.7Hz, 1320/1450 mm
5	Switzerland, 15kV AC 16.7Hz, 1450/1600 mm
6	Switzerland, 15kV AC 16.7Hz, 1950 mm
7	Switzerland, 15kV AC 16.7Hz, 1320/1450/1600 mm
8	Switzerland, 15kV AC 16.7Hz, 1450/1600/1950 mm
9	Switzerland, 15kV AC 16.7Hz, 1320/1450/1600/1950 mm
10	Italy, 3kV DC
11	Italy, 25kV AC 50Hz
12	France, conventional lines, 25kV AC 50Hz
13	France, high speed lines, 25kV AC 50Hz
14	France, 1.5kV DC
15	Spain, conventional lines 220 km/h, 3kV DC
16	Spain, conventional lines 160 km/h, 3kV DC
17	Spain, high speed lines, 25kV AC 50Hz, 1600/1950 mm
18	Spain, high speed lines, 25kV AC 50Hz, 1600 mm
19	Germany, 15kV AC 16.7Hz, 600 A
20	Germany, 15kV AC 16.7Hz, 780 A
21	Germany, 15kV AC 16.7Hz, 900 A
22	Germany, 15kV AC 16.7Hz, 1500 A
23	Slovenia, 3kV DC
24	Denmark, conventional lines 160/200 km/h, 25kV AC 50 Hz
27	Finland, 25kV AC
28	Italy, conventional lines, 2 kV AC 50Hz, 1950mm
29	Israel, 25kV AC 50Hz
30	Norway, 15kV AC 16.7Hz, 450 A, 1800 mm
31	Norway, 15kV AC 16.7Hz, 450 A, 1800/1950 mm
32	Norway, 15kV AC 16.7Hz, 700 A, 1800 mm

## ERA ERTMS UNIT

### ASSIGNMENT OF VALUES TO ETCS VARIABLES

---

33	Norway, 15kV AC 16.7Hz, 700 A, 1800/1950 mm
34	Norway, 15kV AC 16.7Hz, 900 A, 1800 mm
35	Norway, 15kV AC 16.7Hz, 900 A, 1800/1950 mm
36	Czech Republic, 25 kV AC 50 Hz
37	Czech Republic, 3 kV DC
38	Romania, conventional lines 120 km/h, 25kV AC 50 Hz
39	Romania, conventional lines 160 km/h, 25kV AC 50 Hz
40	Sweden, 15kV AC 16.7Hz, 900 A
44	Germany, 1.2kV DC, third rail
45	Portugal, 25kV AC 50Hz, 1450 mm (PT)
46	Portugal, 25kV AC 50Hz, EN50367 A6/1450 mm (PT)
47	Luxemburg, 25 kV AC 50Hz
48	Serbia, conventional and high speed lines, 25kV AC 50Hz
49	Egypt, high speed lines, 25 kV AC 50Hz
50	Slovak Republic, 25kV AC 50Hz
51	Slovak Republic, 3kV DC, 1200 A
52	Slovak Republic, 3kV DC, 1800 A
53	Slovak Republic, 3kV DC, 2000 A
54	Slovak Republic, 3kV DC, 2200 A
55	Slovak Republic, 3kV DC, 2400 A
56	Slovak Republic, 3kV DC, 2800 A
57	Slovak Republic, 3kV DC, 3000 A
58	Slovak Republic, 3kV DC, 3200 A
59	Ireland, DART 1.5kV DC
60	Spain, conventional lines 90 km/h, 1.5kV DC
61	Poland, 25 kV AC 50 Hz (HSR lines)
62	Poland, 3 kV DC (HSR lines)
63	Philippines, 1.5 kV DC, NSCR-N1 line
64	Philippines, 1.5 kV DC, NSCR-Extension line

**3.7. INTENTIONALLY DELETED**

**3.8. INTENTIONALLY DELETED**

## **ANNEXES**

### **A.1 PROCEDURE FOR THE ASSIGNMENT OF THE VALUES**

#### **A.1.1 DEFINITION OF REQUESTING ORGANISATIONS**

The parties involved in the process for the assignment are the ERTMS UNIT of the Agency and the requesting organisations. The Agency will only deal with requests submitted by the following organisations:

- Official representative body of a Member State or of a country outside the European Union,
- ETCS supplier who puts on-board equipments on the market.

#### **A.1.2 REQUEST PROCEDURE**

Any request has to be addressed to the Agency via the request form as given in the annex A.4 or downloadable at the following URL:

<http://www.era.europa.eu/Document-Register/Pages/ETCS-Variables.aspx>

The description of the request should contain valuable information to allow the Agency to analyze the validity of the demand, further to give sense to the meaning of the assigned values at the time of the publication, i.e. reference to real planned project(s) or reference to awarded contracts.

In particular, when range of values to be assigned is requested, the demand shall duly give the reason explaining the impossibility to cover the request with a single value.

#### **A.1.3 WORKFLOW**

The workflow hereafter describes all the steps of the assignment process from the time a request has been raised to the time of the publishing of the value.

# ERA ERTMS UNIT

## ASSIGNMENT OF VALUES TO ETCS VARIABLES

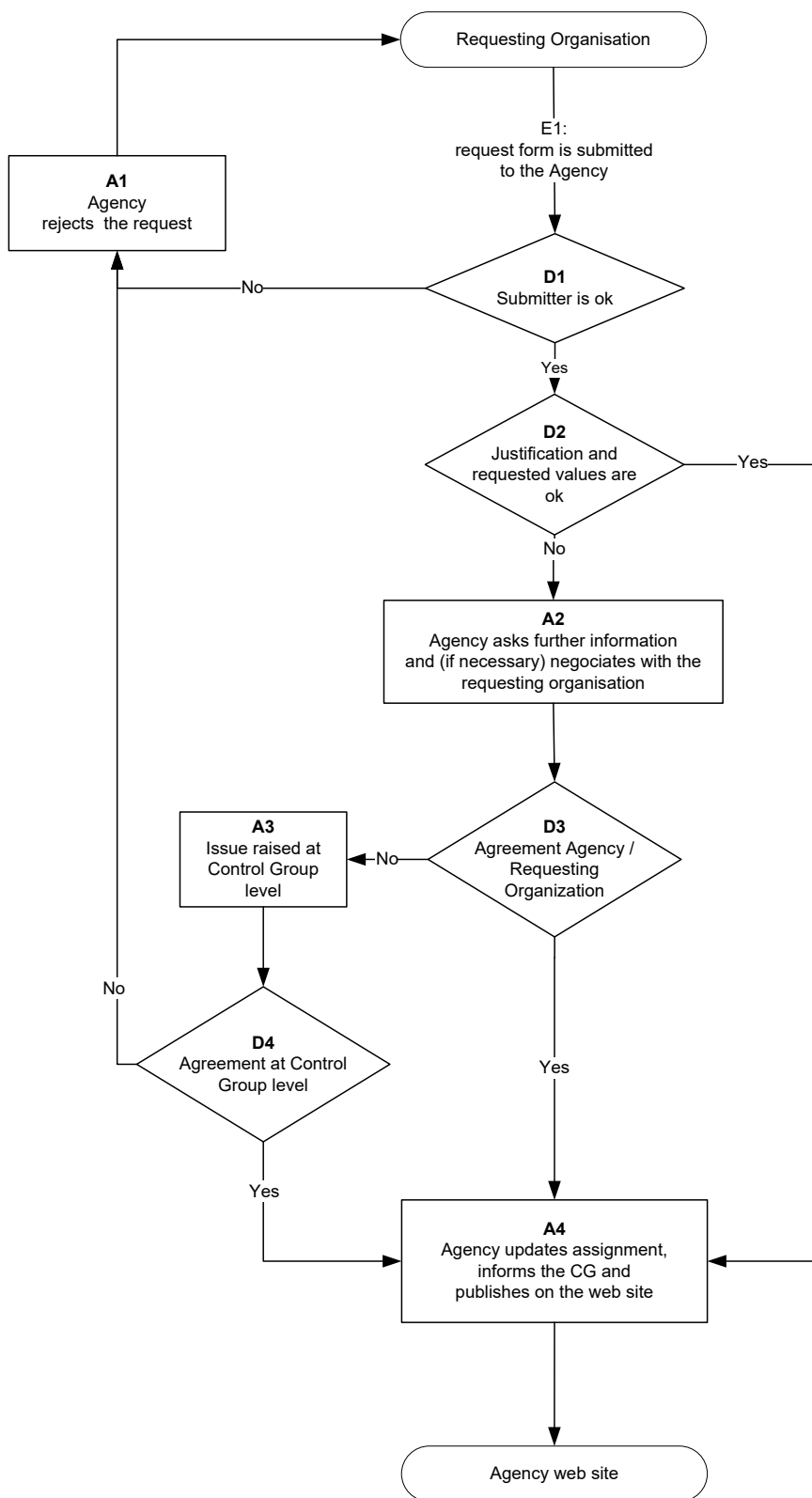

## ERA ERTMS UNIT

### ASSIGNMENT OF VALUES TO ETCS VARIABLES

#	Description	Who
<b>E1</b>	The triggering event is a request form sent to the Agency. The form to be filled is available on the Agency web site at: <a href="http://www.era.europa.eu/Document-Register/Pages/ETCS-Variables.aspx">http://www.era.europa.eu/Document-Register/Pages/ETCS-Variables.aspx</a>	requesting organisation
<b>D1</b>	The Agency checks the correctness of the submitted information regarding the validity of the submitter according to the list of recognized organisations for the assignment process as listed in A.1.1.	Agency
<b>A1</b>	The Agency cannot recognize the requesting entity as valid for the procedure or the Control group has decided to reject the request. The Agency informs the requesting organisation about the reason(s) of rejection.	Agency
<b>D2</b>	The Agency checks if the request is duly justified according to the references of the requesting organisation, reference(s) to the planned project(s) or reference(s) to awarded contracts. A request for a range of values rather than a single value shall also be justified.	Agency
<b>A2</b>	The information given by the recognized organisation to justify the request is not sufficient. The Agency sends back to the submitter a demand for further information. If necessary, negotiation could take place at this step in order to fix the most suitable assignment of value(s).	Agency
<b>D3</b>	When an agreement is made between the Agency and the requesting organisation, the Agency proceeds within the procedure towards the publication. Otherwise, the Agency raises the issue at the level of the Control Group. Whatever the decision is, the requesting organisation is informed about the next step.	Agency, requesting organisation
<b>A3</b>	The Agency has informed the Control Group of an issue and the Control Group decides on the way to continue.	Agency, Control Group
<b>D4</b>	When a positive outcome is found at the level of the control group, the Agency proceeds within the procedure towards the publication. Otherwise the Agency must reject the request.	Agency
<b>A4</b>	The Agency updates the list of values for the ETCS variables and publishes it on the Agency web site. The Agency informs the Control Group too.	Agency

## ERA ERTMS UNIT

### ASSIGNMENT OF VALUES TO ETCS VARIABLES

#### A.2 DETAILED HISTORY OF ASSIGNMENTS

Date of modification	Questions / Remarks	From	Decision	Supporting documents
17/12/25	Request to assign a range of values for NID_ENGINE	CRSC Research & Design Institute Group Co.,Ltd (CRSCD)	Agreed: Range '9960801 to 9960810' is assigned	
26/11/25	Request to assign a range of values for NID_ENGINE	Siemens Rail Automation	Agreed: Range '43340 to 43439' is assigned	
18/11/25	Request to assign a range of values for NID_ENGINE	Siemens Mobility GmbH	Agreed: Range '43180 to 43184' is assigned	
10/11/25	Request to assign a value for NID_CTRACTION	Alstom Transport India Limited	Agreed: Value '64' is assigned	
31/10/25	Request to assign a value for NID_C	FSE (Ferrovie del Sud Est)	Agreed: Value '296' is assigned	
07/10/25	Request to assign a range of values for NID_ENGINE	Siemens Mobility GmbH	Agreed: Range '43169 to 43179' is assigned	
04/09/25	Request to assign values for NID_C	Siemens on behalf of Hafeet Rail	Agreed: Values '870' and '871' are assigned	
27/08/25	Request to assign a range of values for NID_ENGINE	ČD - Telematika a.s.	Agreed: Range '43300 to 43339' is assigned	
25/08/25	Request to assign a range of values for NID_ENGINE	Stadler Signalling AG	Agreed: Range '41770 to 41829' is assigned	
21/08/25	Request to assign a range of values for NID_ENGINE	CRSC Research & Design Institute Group Co.,Ltd (CRSCD)	Agreed: Range '9961001 to 9961300' is assigned	
20/08/25	Request to assign a value for NID_ENGINE	Raab-Oedenburg-Ebenfurter Eisenbahn AG	Agreed: Value '39559' is assigned	
19/08/25	Request to assign a range of values for NID_ENGINE	Hitachi Rail , GTS Deutschland GmbH	Agreed: Range '43250 to 43299' is assigned	
19/08/25	Request to assign a range of values for NID_ENGINE	Hitachi Rail , GTS Deutschland GmbH	Agreed: Range '43200 to 43249' is assigned	
15/07/25	Request to assign a value for NID_XUSER	Alstom Transport India Limited	Agreed: Value '211' is assigned	
15/07/25	Request to assign a value for NID_C	Alstom Transport India Limited	Agreed: Value '904' is assigned	
04/07/25	Request to assign a range of values for NID_ENGINE	Angelstar Srl	Agreed: Range '107443 to 107449' is assigned	
04/07/25	Request to assign a value for NID_CTRACTION	Department of Transportation (DOTr), Philippines	Agreed: Value '63' is assigned	

**ERA ERTMS UNIT**

**ASSIGNMENT OF VALUES TO ETCS VARIABLES**

<b>Date of modification</b>	<b>Questions / Remarks</b>	<b>From</b>	<b>Decision</b>	<b>Supporting documents</b>
04/07/25	Request to assign a value for NID_C	Department of Transportation (DOTr), Philippines	Agreed: Value '903' is assigned	
23/06/25	Request to assign a range of values for NID_C	Metrolinx	Agreed: Range '580 to 599' is assigned	
13/06/25	Request to assign a range of values for NID_ENGINE	Siemens Mobility GmbH	Agreed: Range '43061 to 43168' is assigned	
05/06/25	Request to assign values of NID_NTC	Republic of Türkiye Ministry of Transport and Infrastructure	Agreed: Values '51' and '52' are assigned	
23/05/25	Request to assign a range of values for NID_ENGINE	Angelstar Srl	Agreed: Range '107401 to 107442' is assigned	
21/05/25	Request to assign a range of values for NID_ENGINE	Stadler Bussnang AG	Agreed: Range '12960 to 12965' is assigned	
07/05/25	Request to assign a range of values for NID_ENGINE	Siemens Mobility s.r.o.	Agreed: Range '41750 to 41766' is assigned	
07/05/25	Request to assign two ranges of values for NID_ENGINE	Siemens Mobility GmbH	Agreed: Ranges '41730 to 41739' and '41740 to 41749' are assigned	
11/04/25	Request to assign a range of values for NID_ENGINE	Loram UK	Agreed: Range '43051 to 43060' is assigned	
08/04/25	Request to assign a range of values for NID_ENGINE	Stadler Signalling AG	Agreed: Range '1118001 to 1118044' is assigned	
25/02/25	Request to assign a range of values for NID_ENGINE	DOPSYS s.r.o.	Agreed: Range '41710 to 41729' is assigned	
25/02/25	Request to assign a range of values for NID_ENGINE	Hitachi Rail GTS Austria GmbH	Agreed: Range '41688 to 41709' is assigned	
24/02/25	Request to assign a range of values for NID_ENGINE	Hitachi Rail STS	Agreed: Range '41830 to 41849' is assigned	
10/02/25	Request to assign a value for NID_C	Siemens Rail Automation	Agreed: Value '393' is assigned	
23/01/25	Request to assign two ranges of values for NID_ENGINE	Siemens Rail Automation	Agreed: Ranges '43001 to 43035' and '430036 to 43050' are assigned	
16/01/25	Request to assign a value for NID_C	EAV	Agreed: Value '295' is assigned	
10/01/25	Request to assign values for NID_CTRACTION	Centralny Port Komunikacyjny sp. z o. o. (CPK)	Agreed: Values '61' and '62' are assigned	
10/01/25	Request to assign a value for NID_C	Centralny Port Komunikacyjny sp. z o. o. (CPK)	Agreed: Value '961' is assigned	
15/11/24	Request to assign a range of values for NID_ENGINE	Siemens Mobility GmbH	Agreed: '41850 to 41900' is assigned	
07/11/24	Request to assign a range of values for NID_ENGINE	Hitachi Rail, GTS Austria	Agreed: Range '41901 to 42000' is assigned	
14/10/24	Request to assign a range of values for NID_ENGINE	Siemens Mobility GmbH	Agreed: Range '42801 to 42900' is assigned	
10/10/24	Request to assign a range of values for NID_ENGINE	Angelstar Srl	Agreed: Range '92763 to 92773' is assigned	
10/10/24	Request to assign a range of values for NID_ENGINE	Stadler Signalling AG	Agreed: Range '92774 to 92785' is assigned	



## ERA ERTMS UNIT

### ASSIGNMENT OF VALUES TO ETCS VARIABLES

Date of modification	Questions / Remarks	From	Decision	Supporting documents
25/09/24	Request to assign new values for NID_C	RFI	Agreed: Range '291 to 294' is assigned	
25/09/24	Request to assign two ranges of values for NID_ENGINE	Hitachi Rail, GTS Deutschland GmbH	Agreed: Ranges '42551 to 42600 and 42601 to 42800 are assigned	
17/09/24	Request to assign a range of values for NID_ENGINE	Hitachi Rail, STS	Agreed: Range '42501 to 42550' is assigned	
05/09/24	Request to assign a range of values for NID_ENGINE	Stadler Polska Sp. z o.o.	Agreed: Range '42431 to 42500' is assigned	
23/08/24	Request to assign a range of values for NID_ENGINE	Stadler Polska Sp. z o.o.	Agreed: Range '313012 to 313086' is assigned	
19/08/24	Request to assign a range of values for NID_ENGINE	Stadler Signalling AG	Agreed: Range '315001 to 315020' is assigned	
30/07/24	Request to assign a range of values for NID_ENGINE	Stadler Polska sp. z.o.o.	Agreed: Range '610023 to 610042' is assigned	
25/07/24	Request to assign a value for NID_ENGINE	Raab-Oedenburg-Ebenfurter Eisenbahn AG	Agreed: Value '34891' is assigned	
23/07/24	Request to re-assign a range of values for NID_ENGINE	Stadler Signalling AG	Agreed: Range '900035 to 900102' is re-assigned	
23/07/24	Request to assign a range of values for NID_ENGINE	Siemens Mobility GmbH	Agreed: Range '42181 to 42430' is assigned	
04/07/24	Request to assign a range of values for NID_ENGINE	Stadler Signalling AG	Agreed: Range '39550 to 39558' is assigned	
25/06/24	Request to assign a range of values for NID_ENGINE	Hitachi Rail, GTS Deutschland GmbH	Agreed: Range '39500 to 39549' is assigned	
25/06/24	Request to assign a range of values for NID_ENGINE	CRSC Research & Design Institute Group Co.,Ltd (CRSCD)	Agreed: Range '9960501 to 9960800' is assigned	
11/06/24	Request to assign a range of values for NID_ENGINE	Siemens Mobility GmbH	Agreed: Range '42081 to 42180' is assigned	
23/05/24	Request to assign a range of values for NID_ENGINE	Stadler Signalling AG	Agreed: Range '41661 to 41687' is assigned	
17/05/24	Request to assign new values for NID_C	Siemens Mobility GmbH	Agreed: Values '705 to 707' are assigned	
09/04/24	Request to assign a range of values for NID_ENGINE	Stadler Signalling AG	Agreed: Range '41516 to 41660' is assigned	
02/04/24	Request to assign a range of values for NID_ENGINE	Angelstar Srl	Agreed: Range '41400 to 41515' is assigned	
13/03/24	Request to assign a range of values for NID_ENGINE	Siemens Mobility GmbH	Agreed: Range '41300 to 41399' is assigned	
06/03/24	Request to assign a value for NID_CTRACTION	Euskal Trenbide Sarea	Agreed: Value '60' is assigned	
15/02/24	Request to assign a new value for NID_C	Euskal Trenbide Sarea	Agreed: Value '55' is assigned	
15/02/24	Request to assign a range of values for NID_ENGINE	Siemens Mobility GmbH	Agreed: Range '41200 to 41299' is assigned	
12/02/24	Request to assign a range of values for NID_ENGINE	Hitachi Rail STS	Agreed: Range '39350 to 39499' is assigned	
12/01/24	Request to assign a range of values for NID_ENGINE	Stadler Signalling AG	Agreed: Range '20596 to 20599' is assigned	

**ERA ERTMS UNIT**

**ASSIGNMENT OF VALUES TO ETCS VARIABLES**

<b>Date of modification</b>	<b>Questions / Remarks</b>	<b>From</b>	<b>Decision</b>	<b>Supporting documents</b>
12/01/24	Request to assign a range of values for NID_ENGINE	Eurostar international Limited	Agreed: Range '39331 to 39349' is assigned	
15/12/23	Request to assign a new value for NID_C	Albanian Railway	Agreed: Value '408' is assigned	
15/12/23	Request to assign a range of values for NID_ENGINE	Stadler Signalling AG	Agreed: Range '32781 to 32796' is assigned	
20/10/23	Request to assign a range of values for NID_ENGINE	Siemens Mobility GmbH	Agreed: Range '39560 to 39659' is assigned	
04/10/23	Request to assign a value for NID_ENGINE	Angelstar Srl	Agreed: Value '16776191' is assigned	
25/09/23	Request to assign a range of values for NID_ENGINE	Siemens Mobility GmbH	Agreed: Range '39660 to 39719' is assigned	
21/08/23	Request to assign a range of values for NID_ENGINE	Siemens Mobility GmbH	Agreed: Range '39720 to 39899' is assigned	
21/08/23	Request to assign a range of values for NID_ENGINE	CD Telematika a.s.	Agreed: Range '39301 to 39330' is assigned	
21/08/23	Request to assign a new value for NID_C	Fondo Nacional de Fomento al Turismo - FONATUR	Agreed: Value '918' is assigned	
21/08/23	Request to assign a value for NID_CTRACTION	Iarnród Éireann (Irish Rail)	Agreed: Value '59' is assigned	
03/08/23	Request to assign a range of values for NID_ENGINE	Hitachi Rail STS	Agreed: Range '39251 to 39300' is assigned	
22/06/23	Request to assign a range of values for NID_ENGINE	Stadler Wallisellen AG	Agreed: Range '42001 to 42080' is assigned	
22/06/23	Request to assign a range of values for NID_ENGINE	ŽOS Vrútky, a.s.	Agreed: Range '39222 to 39250' is assigned	
15/06/23	Request to assign a range of values for NID_ENGINE	Siemens Mobility GmbH	Agreed: Range '39900 to 39999' is assigned	
09/05/23	Request to assign three ranges of values for NID_ENGINE	Siemens Mobility GmbH	Agreed: Ranges '40500 to 40999', '41000 to 41099' and '41100 to 41199' are assigned	
09/05/23	Request to assign a range of values for NID_ENGINE	Siemens Mobility GmbH	Agreed: Range '40000 to 40499' is assigned	
09/05/23	Request to assign a range of values for NID_ENGINE	Hitachi Rail STS	Agreed: Range '38782 to 39221' is assigned	
09/05/23	Request to assign a value for NID_ENGINE	Thales Austria	Agreed: value '34890' is assigned	
11/04/23	Request to assign a range of values for NID_ENGINE	Hitachi Rail STS	Agreed: Range '38762 to 38781' is assigned	
30/03/23	Request to assign a range of values for NID_ENGINE	Medway, Operador Ferroviário de Mercadorias S.A	Agreed: Range '38737 to 38761' is assigned	
30/03/23	Request to assign a range of values for NID_ENGINE	ADIF	Agreed: Range '38637 to 38736' is assigned	
09/03/23	Request to assign a range of values for NID_ENGINE	ŽOS Vrútky, a.s.	Agreed: Range '38616 to 38636' is assigned	
23/02/23	Request to assign a range of values for NID_ENGINE	Hitachi Rail STS Sweden	Agreed: Range '38586 to 38615' is assigned	
17/01/23	Request to assign a value for NID_CTRACTION	Siemens Mobility GmbH	Agreed: Value '49' is assigned	
17/01/23	Request to assign a new value for NID_C	Siemens Mobility GmbH	Agreed: Value '704' is assigned	

**ERA ERTMS UNIT**

**ASSIGNMENT OF VALUES TO ETCS VARIABLES**

<b>Date of modification</b>	<b>Questions / Remarks</b>	<b>From</b>	<b>Decision</b>	<b>Supporting documents</b>
06/12/22	Request to assign a range of values for NID_ENGINE	Stadler Signalling AG	Agreed: Range '314001 to 314118' is assigned	
30/11/22	Request to assign a range of values for NID_ENGINE	Siemens Mobility GmbH	Agreed: Range '107350 to 107400' is assigned	
09/11/22	Request to assign a range of values for NID_ENGINE	CAF Signalling	Agreed: Range '37586 to 38585' is assigned	
04/11/22	Requests to assign ranges of values for NID_ENGINE	Hitachi Rail STS	Agreed: Ranges '36976 to 37165', '37166 to 37225', '37226 to 37385' and '37386 to 37585' are assigned	
25/10/22	Request to assign a range of values for NID_ENGINE	Thales UK	Agreed: Range '36926 to 36975' is assigned	
26/08/22	Request to assign a range of values for NID_ENGINE	ŽOS Vrútky, a.s.	Agreed: Range '36885 to 36925' is assigned	
26/08/22	Request to assign a range of values for NID_ENGINE	Siemens	Agreed: Range '20586 to 20595' is assigned	
18/08/22	Request to withdraw a value of NID_XUSER	Iarnród Éireann (Irish Rail)	Agreed: Value 353 removed	
18/08/22	Request to assign a range of values for NID_ENGINE	Iarnród Éireann (Irish Rail)	Agreed: Range '36385 to 36884' is assigned	
15/07/22	Request to assign a range of values for NID_ENGINE	Softronic	Agreed: Range '36185 to 36384' is assigned	
21/06/22	Request to assign a new value for NID_C	Fondo Nacional de Fomento al Turismo - FONATUR	Agreed: Value '919' is assigned	
16/06/22	Request to assign a range of values for NID_ENGINE	Siemens Mobility GmbH	Agreed: Range '35985 to 36184' is assigned	
09/06/22	Request to assign a range of values for NID_ENGINE	Hitachi Rail STS Sweden	Agreed: Range '35935 to 35984' is assigned	
01/06/22	Request to assign a range of values for NID_ENGINE	The Signalling Company	Agreed: Range '35825 to 35934' is assigned	
01/06/22	Request to assign a range of values for NID_ENGINE	Hitachi Rail STS Sweden	Agreed: Range '12930 to 12939' is assigned	
01/06/22	Request to assign a range of values for NID_ENGINE	Stadler Signalling AG	Agreed: Range '12940 to 12959' is assigned	
12/05/22	Request to assign a range of values for NID_ENGINE	BETAMONT s.r.o.	Agreed: Range '35800 to 35824' is assigned	
11/04/22	Request to assign new values for NID_C and refine allocation of already assigned values	Federal Office of Transport	Agreed: Range '456 to 465' is assigned	
07/04/22	Request to assign a new value for NID_NTC	SNCF Réseau	Agreed: Value '47' is assigned	
30/03/22	Request to assign a range of values for NID_ENGINE	Stadler Polska Sp. z o.o.	Agreed: Range '20990 to 20997' is assigned	
25/03/22	Request to assign a range of values for NID_ENGINE	Siemens Mobility GmbH	Agreed: Range '34892 to 34899' is assigned	
25/03/22	Request to assign a new value for NID_C	Infrastructure of Serbian Railways JSC (IZS)	Agreed: Value '406' is assigned	
10/03/22	Request to assign a range of values for NID_ENGINE	Queensland Rail	Agreed: Range '107000 to 107319' is assigned	
10/03/22	Request to assign a new value for NID_XUSER	Queensland Rail	Agreed: Value '44' is assigned	
18/02/22	Request to assign a range of values for NID_ENGINE	Hitachi Rail STS SpA	Agreed: Range '35700 to 35799' is assigned	

**ERA ERTMS UNIT**

**ASSIGNMENT OF VALUES TO ETCS VARIABLES**

<b>Date of modification</b>	<b>Questions / Remarks</b>	<b>From</b>	<b>Decision</b>	<b>Supporting documents</b>
18/02/22	Request to assign a range of values for NID_ENGINE	Thales Austria GmbH	Agreed: Range '35600 to 35699' is assigned	
18/02/22	Request to assign a range of values for NID_ENGINE	Stadler Signalling AG	Agreed: Range '20574 to 20576' is assigned	
27/10/21	Request to assign a range of values for NID_ENGINE	Hitachi Rail STS Sweden	Agreed: Range '91640 to 91799' is assigned	
25/10/21	Request to assign values for NID_C	National Capital Region Transport Corporation	Agreed: Values '806 & 807' are assigned	
11/10/21	Request to assign a range of values for NID_ENGINE	Hitachi Rail STS	Agreed: Range '35500 to 35599' is assigned	
11/10/21	Request to assign a range of values for NID_ENGINE	JSC "Serbia Train"	Agreed: Range '34870 to 34889' is assigned	
04/10/21	Request to assign a range of values for NID_ENGINE	OUIGO España	Agreed: Range '35460 to 35499' is assigned	
27/09/21	Request to assign a range of values for NID_ENGINE	CRSC Research & Design Institute Group Co.,Ltd (CRSCD)	Agreed: Range '9960000 to 9960500' is assigned	
15/09/21	Request to assign a range of values for NID_ENGINE	ZHUZHOU CRRC TIMES ELECTRIC CO., LTD	Agreed: Range '8862001 to 8864000' is assigned	
09/09/21	Request to assign a range of values for NID_ENGINE	Hitachi Rail STS Sweden	Agreed: Range '91800 to 91999' is assigned	
06/09/21	Request to extend a range of values of NID_ENGINE	Alstom	Agreed: Range '93000 to 96999' is extended to 106999	
25/05/21	Request to assign a range of values for NID_ENGINE	Siemens Mobility GmbH	Agreed: Range '35360 to 35459' is assigned	
19/04/21	Request to assign a new value for NID_NTC	Network Rail	Agreed: Value '50' is assigned	
08/03/21	Request to assign a range of values for NID_ENGINE	Siemens Mobility GmbH	Agreed: Range ' 35220 to 35359' is assigned	
30/10/20	Request to assign a range of values for NID_ENGINE	Stadler Signalling AG	Agreed: Range ' 900001 to 900250' is assigned	
19/10/20	Request to assign a range of values for NID_ENGINE	Siemens Mobility Limited	Agreed: Range ' 92020 to 92762' is assigned	
05/10/20	Request to assign a range of values for NID_ENGINE	Stadler Bussnang AG	Agreed: Range ' 91520 to 91619' is assigned	
05/10/20	Request to assign a range of values for NID_ENGINE	Stadler Polska Sp. z o.o.	Agreed: Range '32761 to 32780' is assigned	
29/09/20	Request to assign a new value for NID_NTC	Infrastructure of Serbian Railways JSC (IZS)	Rejected: Value '27' was already assigned for INUSI I60 and is modified accordingly	
29/09/20	Request to assign a new value for NID_XUSER	Infrastructure of Serbian Railways JSC (IZS)	Agreed: Value '21' is assigned	
29/09/20	Request to assign a value for NID_CTRACTION	Infrastructure of Serbian Railways JSC (IZS)	Agreed: Value '48' is assigned	

## ERA ERTMS UNIT

### ASSIGNMENT OF VALUES TO ETCS VARIABLES

Date of modification	Questions / Remarks	From	Decision	Supporting documents
29/09/20	Request to assign values for NID_C	Infrastructure of Serbian Railways JSC (IZS)	Agreed: Range '400 to 405' is assigned	
15/09/20	Request to assign a value for NID_CTRACTION	Société Nationale des Chemins de Fer Luxembourgeois	Agreed: Value '47' is assigned	
11/09/20	Request to assign values for NID_CTRACTION	Transport Authority Slovakia	Agreed: Values '50 to 58' are assigned	
03/08/20	Request to assign a value for NID_C	Tanzania Railway Corporation	Agreed: Value '808' is assigned	
03/08/20	Request to assign a range of values for NID_ENGINE	ZHUZHOU CRRC TIMES ELECTRIC CO., LTD	Agreed: Range '8860000 to 8862000' is assigned	
21/07/20	Request to assign a value for NID_C	Ethiopian Railway Corporation	Agreed: Value '809' is assigned	
03/07/20	Request to assign a range of values for NID_ENGINE	Stadler Polska	Agreed: Range '32737 to 32760' is assigned	
25/06/20	Request to assign values for NID_C	Portuguese NSA – IMT	Agreed: Range '51 to 53' is assigned	
23/06/20	Request to assign a value for NID_C	Ministerio de Transporte y Obras Públicas (Uruguay)	Agreed: Value '936' is assigned	
23/06/20	Request to assign values for NID_CTRACTION	Portuguese NSA – IMT	Agreed: Values '45&46' are assigned	
15/04/20	Request to assign a new value for NID_XUSER	Department of Planning, Transport and Infrastructure (Australia)	Agreed: Value '210' is assigned	
27/03/20	Request to assign a range of values for NID_ENGINE	Siemens Mobility GmbH	Agreed: Range '91350 to 91519' is assigned	
03/02/20	Request to assign a range of values for NID_ENGINE	Siemens Mobility GmbH	Agreed: Range '35100 to 35219' is assigned	
03/01/20	Request to assign a range of values for NID_ENGINE	Siemens Mobility GmbH	Agreed: Range '34900 to 34999' is assigned	
12/12/19	Request to assign a range of values for NID_ENGINE	Siemens Mobility GmbH	Agreed: Range '34770 to 34869' is assigned	
19/11/19	Request to assign a range of values for NID_ENGINE	Siemens Mobility GmbH	Agreed: Range '35000 to 35099' is assigned	
12/11/19	Request to assign values for NID_C	PKP Polskie Linie Kolejowe S.A.	Agreed: Range '951 to 960' is assigned	
04/11/19	Request to assign a new value for NID_CTRACTION	DB Netz AG	Agreed: Value '44' is assigned	
21/10/19	Request to assign a range of values for NID_ENGINE	Stadler Bussnang AG	Agreed: Range '20571 to 20573' is assigned	
15/10/19	Request to assign a range of values for NID_ENGINE	Thales Germany	Agreed: Range '91200 to 91349' is assigned	
27/09/19	Request to assign values for NID_C	Iarnród Éireann (Irish Rail)	Agreed: Range '1022 to 1023' is assigned	



## ERA ERTMS UNIT

### ASSIGNMENT OF VALUES TO ETCS VARIABLES

Date of modification	Questions / Remarks	From	Decision	Supporting documents
30/08/19	Request to assign ranges of values for NID_ENGINE	Stadler Polska Sp. z o.o.	Agreed: Ranges '313002 to 313011', '510002 to 510022' and '610002 to 610022' are assigned	
12/08/19	Request to prevent the use of NID_NTC = 31	Federal Office of Transport	Agreed: value 31 removed from the table 3.3	
08/08/19	Request to refine definition of NID_C values	Federal Office of Transport	Agreed: definition of values '448 to 455' refined	
30/07/19	Request to assign a range of values for NID_ENGINE	Hitachi Rail STS Sweden	Agreed: Range '12920 to 12929' is assigned	
19/06/19	Request to assign a range of values for NID_ENGINE	Thales Germany	Agreed: Range '34650 to 34769' is assigned	
11/06/19	Request to assign new values for NID_C	Infrabel	Agreed: Values '251 & 252' are assigned	
03/05/19	Request to assign a new value for NID_XUSER	Ansaldo STS (on behalf of TfNSW)	Agreed: Value '103' is assigned	
02/04/19	Request to assign a value for NID_C	Thales (on behalf of SCT)	Agreed: Value '920' is assigned	
01/04/19	Request to assign a range of values for NID_ENGINE	Siemens Mobility GmbH	Agreed: Range '34600 to 34649' is assigned	
29/03/19	Request to assign a range of values for NID_ENGINE	Siemens Mobility GmbH	Agreed: Range '34400 to 34599' is assigned	
29/03/19	Request to assign a range of values for NID_ENGINE	ProRail	Agreed: Range '32800 to 32849' is assigned	
27/03/19	Request to assign a range of values for NID_ENGINE	Ansaldo STS	Agreed: Range '34300 to 34399' is assigned	
21/02/19	Request to assign a range of values for NID_ENGINE	Stadler Polska	Agreed: Range '32666 to 32736' is assigned	
14/12/18	Request to assign a new value for NID_CTRACTION	Swedish Transport Agency (Transportstyrelsen)	Agreed: Value '40' is assigned	
20/09/18	Request to assign a range of values for NID_ENGINE	Stadler Altenrhein AG	Agreed: Range '800001 to 800160' is assigned	
19/09/18	Request to assign a value for NID_C	TER Dakar (Senegal)	Agreed: Value '805' is assigned	
17/09/18	Request to assign a new value for NID_XUSER	SNCF Réseau	Agreed: Value '97' is assigned	
14/09/18	Information of use of the value '9' of NID_NTC by Israel Railways (ISR)	Bombardier	Agreed: description of value '9' modified accordingly	
15/06/18	Request to assign a range of values for NID_ENGINE	Siemens	Agreed: Range '6062500 to 6062549' is assigned	
17/05/18	Request to assign a range of values for NID_ENGINE	Siemens	Agreed: Range '3003700 to 3003899' is assigned	
19/04/18	Request to assign a value for NID_C	Siemens (on behalf of Aurizon Operations Ltd)	Agreed: Value '617' is assigned	
16/04/18	Request to assign a value for NID_C	Alstom (on behalf of Light Rail Transit Authority – Manila)	Agreed: Value '902' is assigned	

**ERA ERTMS UNIT**

**ASSIGNMENT OF VALUES TO ETCS VARIABLES**

<b>Date of modification</b>	<b>Questions / Remarks</b>	<b>From</b>	<b>Decision</b>	<b>Supporting documents</b>
09/04/18	Request to assign a range of values for NID_ENGINE	ECM S.p.A.	Agreed: Range '34000 to 34299' is assigned	
14/03/18	Request to assign a range of values for NID_ENGINE	PKP Intercity S.A.	Agreed: Range '32626 to 32665' is assigned	
14/03/18	Request to assign a value for NID_C	AZD	Agreed: Value '504' is assigned	
19/02/18	Request to assign a range of values for NID_ENGINE	Banedanmark	Agreed: Range '91150 to 91199' is assigned	
31/01/18	Request to assign a range of values for NID_C	Siemens (on behalf Directorate General of Railways from Indonesia)	Agreed: Values '940' to '950' are assigned	
26/01/18	Request to assign new values for NID_CTRACTION	ASFR (NSA Romania)	Agreed: Values '38' & '39' are assigned	
22/01/18	Request to assign a range of values for NID_ENGINE	Siemens	Agreed: Range '32850 to 32899' is assigned	
04/12/17	Request to assign new values for NID_CTRACTION	SZDC	Agreed: Values '36' & '37' are assigned	
23/10/17	Request to assign a new value for NID_XUSER	SNCF Réseau	Agreed: Value '98' is assigned	
02/10/17	Request to assign a range of values for NID_ENGINE	Alstom	Agreed: Range '93000 to 96999' is assigned	
30/08/17	Confirmation of use of value '420' of NID_C	Slovak Transport authority	Agreed. Value '20' is assigned	
28/08/17	Confirmation of reserved range of values '386-390' for NID_C and of value 20 of NID_XUSER	ÖBB	Agreed	
28/08/17	Confirmation of use of value '1048576' of NID_ENGINE	AZD	Value '1048576' of NID_ENGINE is assigned	
18/08/17	Request to assign new values for NID_CTRACTION	Bane NOR SF (Norwegian Infrastructure Manager)	Agreed. Values '30' to '35' are assigned.	
07/08/17	Request to assign a range of values for NID_ENGINE	Stadler Altenrhein AG	Agreed: Range '701001 to 701150' is assigned	
26/05/17	Request to reserve a range of values for NID_C	Network Rail	Agreed. Range '27' to '50' is reserved.	
24/05/17	Request to assign a range of values for NID_ENGINE	Siemens	Agreed: Range '92000 to 92019' is assigned	
24/05/17	Request to assign a new value for NID_CTRACTION	Israel Railways Ltd	Agreed. Value '29' is assigned	
24/05/17	Request to assign a new value for NID_C	Israel Railways Ltd	Agreed. Value '391' is assigned	
24/05/17	Request to assign a range of values for NID_C	Thales on behalf of State Railway of Thailand	Agreed. Values '830' to '850' are assigned.	
16/11/16	Request to refine the assignment of existing values of NID_C	Network Rail	Agreed. Reserved values '3' to '6' and '26' are assigned.	

## ERA ERTMS UNIT

### ASSIGNMENT OF VALUES TO ETCS VARIABLES

Date of modification	Questions / Remarks	From	Decision	Supporting documents
11/10/16	Request for an extension of range for NID_ENGINE	CAY management AG on behalf of WESTbahn Management GmbH and Stadler Altenrhein AG	Agreed. Range extended from '1217000' to '1217100'	
03/08/16	Request for assignment to NID_C	Bombardier	Agreed: Value '555' is assigned	
28/07/16	Request to assign a range of 100 values for NID_ENGINE	Siemens	Agreed: Range '32900 to 32999' is assigned	
21/07/16	Request to assign a new value for NID_CTRACTION	RFI	Agreed: Value '28' is assigned	
21/07/16	Request for assignment to NID_C	RFI	Agreed: Value '290' is assigned	
18/07/16	Request to assign a range of 30 values for NID_ENGINE	Siemens	Agreed: Range '91120' to '91149' is assigned	
18/07/16	Request to assign a range of 200 values for NID_ENGINE	Hitachi Rail Europe	Agreed: Range '12720' to '12919' is assigned	
14/06/16	Request to assign a new value for NID_CTRACTION	Danish Transport and Construction Agency	Agreed: Value '24' is assigned	
20/05/16	Request to assign a range of 1000 values for NID_ENGINE	CAF	Agreed: Range '33000' to '33999' is assigned	
04/04/16	Request to assign a range of 20 values for NID_ENGINE	ADIF	Agreed: Range '12700' to '12719' is assigned	
16/03/16	Confirmation of value 9 of NID_XUSER	RSSB	Agreed	
06/01/16	Request to assign a range of 34 values for NID_ENGINE	Eurostar international Limited	Agreed: Range '12966' to '12999' is assigned	
06/01/16	Request to assign a new range of values for NID_C	Queensland Rail	Agreed: Range '547' to '549' is assigned	
18/11/15	Request to assign a new value for NID_XUSER	Danish Transport and Construction Agency	Agreed: Value '8' is assigned	
18/11/15	Request to assign a new value for NID_CTRACTION	Finnish Transport Agency	Agreed: Value '27' is assigned	
17/11/15	Request for an extension of range for NID_C	Finnish Transport Agency	Agreed: Range '322' to '335' is assigned	
17/11/15	Request to assign a new value for NID_NTC	SNCF Réseau	Agreed: Value '29' is assigned	
31/08/15	Request to assign a range of 60 values for NID_ENGINE	PESA Bydgoszcz SA	Agreed: Range '32566' to '32625' is assigned	
04/08/15	Request to assign a range of 120 values for NID_ENGINE	Siemens	Agreed: Range '91000' to '91119' is assigned	
08/06/15	Request for assignment to NID_C	South Africa (PRASA)	Agreed: Values '820 to 823' are assigned	
07/05/15	Request for assignment to NID_XUSER	New Zealand Railways Corporation (KiwiRail)	Agreed: Value '200' is assigned	



**ERA ERTMS UNIT**

**ASSIGNMENT OF VALUES TO ETCS VARIABLES**

<b>Date of modification</b>	<b>Questions / Remarks</b>	<b>From</b>	<b>Decision</b>	<b>Supporting documents</b>
29/04/15	Request to assign a range of 15 values for NID_ENGINE	Siemens	Agreed: Range '32551' to '32565' is assigned	
29/04/15	Request for assignment to NID_C	RFI	Agreed: Value '289' is assigned	
20/02/15	Request for assignment to NID_C	EFE (Chile)	Agreed: Value '922' is assigned	
16/01/15	Request for assignment to NID_C	Siemens / AO NK "KTZh"	Agreed: Value '511' is assigned	
09/01/15	Request to assign a new value for NID_C	Macedonian Railways Infrastructure	Agreed: Value '338' is assigned	
17/11/14	Request to assign a range of 50 values for NID_ENGINE	Siemens	Agreed: Range '32501' to '32550' is assigned	
16/09/14	Request to assign a range of 2 values for NID_ENGINE	Siemens	Agreed: Range '20569' to '20570' is assigned	
16/09/14	Request to assign a range of 40 values for NID_ENGINE	PKP Intercity S.A.	Agreed: Range '20950' to '20989' is assigned	
04/08/14	Request to assign a range of 250 values for NID_ENGINE	Siemens	Agreed: Range '20700' to '20949' is assigned	
04/08/14	Request to assign a range of 500 values for NID_ENGINE	Siemens	Agreed: Range '32001' to '32500' is assigned	
04/08/14	Request for assignment to NID_C	Siemens / SRO	Agreed: Value '880' is assigned	
04/08/14	Correction of a typo error "Metropolitana"	PKM/UTK		
19/06/14	Request to assign a range of 100 values for NID_ENGINE	Bombardier-RCS	Agreed: Range '20600' to '20699' is assigned	
19/06/14	Request to assign a range of 6 values for NID_ENGINE	Siemens	Agreed: Range '20580' to '20585' is assigned	
19/06/14	Request to assign a range of 2 values for NID_ENGINE	Siemens	Agreed: Range '20567' to '20568' is assigned	
19/06/14	Request for assignment to NID_C	Pomorska Kolej Metropolitarna / UTK	Agreed: Value '339' is assigned	
20/05/14	Request to assign a new value for NID_NTC	Network Rail	Agreed: Value '21' is assigned	
15/05/14	Request to assign a range of 16 values for NID_ENGINE	Siemens	Agreed: Range '20551' to '20566' is assigned	
15/05/14	Request for extension to a new line of a previously assigned NID_C value	Ministry of Sea, Transport and Infrastructure (Croatia)	Agreed: scope of value '501' extended	
15/05/14	Request for re-assignment of NID_ENGINE	Ferrovie dello Stato (FS)	Agreed: Range '1200' to '1399' re-assigned to Ansaldo	
15/05/14	Request for assignment to NID_C	Department of Planning, Transport & Infrastructure (DPTI) South Australia	Agreed: Value '546' is assigned	
22/03/13	Request for assignment to NID_C	ALSTOM Transport / TCDD	Agreed: Value '409' is assigned	
11/03/13	Request for assignment to NID_C	BaneDanmark	Agreed: Range '344' to '350' is assigned	

## ERA ERTMS UNIT

### ASSIGNMENT OF VALUES TO ETCS VARIABLES

Date of modification	Questions / Remarks	From	Decision	Supporting documents
18/02/13	Request for transfer of responsibility for NID_XUSER	Thales	Agreed: NID_XUSER='10' re-assigned to MAV	
05/02/13	Request to assign a range of 500 values for NID_ENGINE	General Electric Transportation	Agreed: Range '21500' to '21999' is assigned	
20/12/12	Confirmation of Swedish values of NID_C (530 to 535)	Swedish Transport Agency (Transportstyrelsen)	Current row split in two rows	
08/10/12	Request to assign a range of 500 values for NID_ENGINE	Hitachi Rail Europe	Agreed: Range '12200' to '12699' is assigned	
25/09/12	Request for an extension of range for NID_C and redefinition of values 1 and 2 for NID_C	Network Rail	Agreed: the range is extended from '3' to '26'	
10/07/12	Confirmation that Bulgaria uses the value '392' of NID_C.	NSA of Bulgaria	Agreed.	
28/03/12	Request for a value of NID_CTRACTION	AŽP	Value '23' is allocated	
26/03/12	Request for an extension of range for NID_C and redefinition of values	MÁV, Hungary	Agreed: the range is extended from '416' to '419'.	
15/03/12	Request from the United Arab Emirates to keep track of value '882' for NID_C	Etihad Rail	Value '882' for NID_C is assigned to UAE	
24/02/12	Request for assignment to NID_C and to NID_XUSER	Thales Transportation Systems	NID_XUSER='50' is assigned as 'Thales ETCS OBS'. NID_C values cannot be assigned to suppliers	
09/02/12	Request the assignment of a set of NID_ENGINE values for the ERTMS project Supervia in Brazil.	Bombardier-RCS	Range '21000' to '21499' is assigned.	
03/02/12	Request from Turkey to assign a range of 1000 values for NID_ENGINE	TCDD	Range '90000' to '90999' is assigned.	
02/02/12	Request to keep track of values for NID_C used outside Europe	Bombardier-RCS	Range '930' to '935' is used in Brazil.	
27/01/12	Extension of range for NID_C	MÁV, Hungary	Agreed: the range is extended from '416' to '418'.	
12/01/12	Creation of the list of allocated values for NID_CTRACTION and a dedicated section for the detailed parameters.	ERA		
03/01/12	Request from Belgium for a range in the variables NID_ENGINE	SNCB/ NMBS	Range '30001' to '32000' is allocated.	

## ERA ERTMS UNIT

### ASSIGNMENT OF VALUES TO ETCS VARIABLES

Date of modification	Questions / Remarks	From	Decision	Supporting documents
25/11/11	Request from the Public Agency of the Republic of Slovenia for a range in the variables NID_C, NID_ENGINE, NID_STM and NID_XUSER	AŽP	Agreed for NID_C, NID_ENGINE, and NID_XUSER. The justification for a new value in the NID_STM list is still missing.	
24/11/11	Request from MRCE Dispolok GmbH for a range in the variable NID_ENGINE	MRCE Dispolok GmbH	Range '1217101' to '1217150' is allocated to ETCS on-board units "MRCE Dispolok – ES64U2 / Trainguard 200"	
17/11/11	Request from the Spanish Ministry of Development to update the definition of the variables NID_C and NID_ENGINE	Ministerio de Fomento, España	Agreed.	
11/08/11	Request for allocation of a range of values for NID_ENGINE	Siemens AG	Range '8850000' to '8859999' is allocated to ETCS on-board units for Saudi Arabia Dammam-Riyadh line	
17/05/11	Request for allocation of a range of values for NID_ENGINE	Stadler Rail Group/Siemens AG for WESTbahn Management GmbH	Range '1217000' to '1217050' is allocated to project KISS-WESTbahn MeA4010	
07/04/11	Confirmation that Ankara Konya High Speed line uses value '415' of NID_C.	Invensys	Agreed.	
05/04/11	Request for a NID_C and a NID_STM value for Malaysia	Bombardier	The value '901' is assigned for NID_C and the value '46' is assigned for NID_STM.	
31/01/11	Information about NID_C value '540': an update is needed for the data regarding 'Confirmed by'. Information about a NID_C range of values for Australia projects.	RailCorp	The 'Confirmed by' data is updated. The range from '541' to '545' is reserved.	
31/01/11	Information about a NID_C value for a Chinese project.	Ansaldo-STC	The value '554' is assigned to the HS line Zhengzhou-Xi'an.	
31/01/11	Information about a NID_C range of values for Kazakhstan projects.	Ansaldo-STC	The value '550' is assigned to the Zhetygen – Korgas line. The range from '551' to '553' is reserved.	
31/01/11	Information about a NID_C range of values for Russian projects.	Ansaldo-STC	The value '570' is assigned to the Khosta – Matsesta line. The range from '571' to '573' is reserved.	
24/01/11	Request for a NID_C value for Kazakhstan and a block of 1500 values for NID_ENGINE	Bombardier	Keep track of value '510' for Kazakhstan and extend '19050' to '20550'.	

## ERA ERTMS UNIT

### ASSIGNMENT OF VALUES TO ETCS VARIABLES

Date of modification	Questions / Remarks	From	Decision	Supporting documents
17/01/11	Request for a contiguous block of 2000 values for NID_ENGINE	Bombardier	The range from '17051' to '19050' is assigned to Bombardier.	
21/10/10	Request for a new cant deficiency value of 210 mm for NC_TRAIN	EEIG	Accepted (see CR 946): value '14' of NC_TRAIN is assigned to 210 mm.	
01/10/10	Request for a value of NID_XUSER	RFF	Value '6' is assigned to RFF.	
19/09/10	Confirmation about NID_ENGINE that ranges of values from 1116001 to 1116999 and from 1216001 to 1216999 is used by ÖBB.	ÖBB	Keep track of confirmation	
22/06/10	NC_TRAIN: note for pending definition of Passenger Train removed	ERA	The definition can be found in the TSI RST Loc&PAS	
15/06/10	M_LOADINGGAUGE: inconsistency and Control Group not finalized decision	ERA	Removal of values	
28/05/10	Information about NID_C values for Libyan project.	Ansaldo-STC	Keep track of range '701' to '703' for NID_C	
19/03/10	Information about NID_C, NID_ENGINE values for Saudi Arabia project.	Thales	Keep track of range '883' to '884' for NID_C and range '8840000' to '8849999' for NID_ENGINE	
15/03/10	Information about NID_C values for Turkey	Ansaldo-STC	Keep track of range '412' to '415' for NID_C.	
26/02/10	Request for a range of values of NID_C for Morocco	Thales	Keep track of range '810' to '819' for NID_C.	
26/02/10	Request for a range of values of M_TRACTION, NID_C, NID_ENGINE, NID_STM	Croatia, Ministry of the Sea, transport and Infrastructure	Keep track of range '71' to '75' for M_TRACTION, range '501' to '503' for NID_C, range '1117000 to 1117499' for NID_ENGINE, value '27' for NID_STM.	
17/02/10	Restart version number to achieve consistency with the new single ETCS variable file	ERA	Start version 1.0 dated 17/02/2010	
16/12/09	The railway infrastructure of Belgium (NV INFRABEL) asks 50 numbers of NID_ENGINE to use in there exploitation	NV INFRABEL	Values '17000' to '17050' have been assigned for NID_ENGINE.	
15/12/09	Request for a new cant deficiency value of 245 mm for NC_TRAIN	EEIG	Accepted (see CR 884)	
30/11/09	Request for a range of ten values of NID_C for Norway	Jernbaneverket	Values '520' to '529' have been assigned for NID_C.	
07/10/09	Request for a range of four values of NID_C for Poland	PKP Polish Railway Lines JSC	Values '340' to '343' have been assigned for NID_C.	

## ERA ERTMS UNIT

### ASSIGNMENT OF VALUES TO ETCS VARIABLES

Date of modification	Questions / Remarks	From	Decision	Supporting documents
02/09/09	Request for one value of NID_C and for a range of values of M_TRACTION for New Zealand	New Zealand Railways Corporation Kiwi Rail	Values '600' has been assigned for NID_C. Values '201' to '205' have been assigned for M_TRACTION.	
05/05/09	Request for a range of value of NID_C for Algeria	Thales	Values '800' has been assigned for the project 'Algeria Rocade Nord'. Values '801' to '804' have been reserved for future Algerian projects.	
28/04/09	Request for an update of the description for the values of M_TRACTION assigned to Germany	DB AG	Modification of the max. current values for the values '11' to '15' of M_TRACTION as well as the corresponding column 'confirmed by'	
02/04/09	Request for a value of NID_C for Marmaray ERTMS project as well as two values of NID_XUSER	ALSTOM transport Belgium	Assignment of NID_C= '411' for the Marmaray ERTMS project as well as NID_XUSER values 16 and 17.	
02/04/09	Request for a range of values for NID_ENGINE.	Ansaldo Breda	Range from '16000' to '16120' decimal is assigned.	
10/11/08	Request for an additional value for NID_C for Greece.	EDISY S.A.	Assignment of NID_C= '475' for the line "Athens – Thessaloniki –Bulgaria level 1 corridor."	
29/09/08	A dedicated ERA Workshop has been held on 24th June 2008 with the objective to redefine the international train categories.		In September, the Control Group endorsed the conclusions made during the June workshop. The table for NC_TRAIN is updated.	
22/07/08	Request to implement a national function for the transition between catenary systems using the packet 44 as defined in the ETCS Specifications	Belgium (Service Public Fédéral Mobilité et Transports)	Value '99' is allocated to NID_XUSER as 'track conditions for national systems in areas not fitted with ETCS in Belgium'	
13/06/08	For the UK application, request for a range of 1000 values for NID_ENGINE to support the next five years of planned rollout.	RSSB New Systems	Range from '15000' to '15999' decimal is assigned.	
17/03/08	Confirmation from SBB for the use of allocated range of values for NID_ENGINE	SBB	Accepted	



## ERA ERTMS UNIT

### ASSIGNMENT OF VALUES TO ETCS VARIABLES

Date of modification	Questions / Remarks	From	Decision	Supporting documents
<b>08/02/08</b>	Request for additional values reserved within the range from '13000' to '14999' in the NID_ENGINE table. Request for a correction in the same table (provision for the range from '5000' to '6999' rather than from '5000' to '6900' as previously indicated by the company)	Alstom	Range from '13000' to '14999' decimal is assigned. Correction to '6999' decimal is made.	
<b>14/12/07</b>	ERA was informed that the value '889' of NID_C has been chosen for the line between cities Wuhan and Guangzhou in China. For the system CTCS-2 the value '45' of NID_STM has been taken. System owner is China MoR (Ministry of Railway).	Bombardier Transportation AB	Update table NID_C with value '889' decimal, and table NID_STM with value '45' decimal.	
<b>14/12/07</b>	ERA was informed that the value '921' of NID_C has been chosen for the line between Buenavista and Cuautitlán in Mexico.	Thales Rail Signalling Solutions, S.L.U.	Update table NID_C with value '921' decimal.	
<b>02/12/07</b>	Request for assigning a range of 200 values to NID_ENGINE for installation of ETCS in diesel locomotives Class'66 and diesel locomotives G1206.	Lloyd's Register Rail Europe B.V.	Range from '12000' to '12199' decimal is assigned.	
<b>12/10/07</b>	Request for assigning NID_STM value for system TBL1+ in Belgium	Service public fédéral Mobilité et Transports	Value '28' decimal is assigned	
<b>06/09/07</b>	Request for assigning NID_C value for Perpignan Figueras mixed traffic line	TP FERRO	Value '351' decimal is assigned	
<b>08/08/07</b>	Request for assigning an NID_C value for Turkey "Ankara-Istanbul High Speed Line"	TCDD	Value '410' decimal is assigned	
<b>26/06/07</b>	Request to correct the name of the country assigned to NID_C value 540. It shall read 'Australia', instead of 'Austria'.	ISV, SIEMENS	Correct the mistake	
<b>23/05/07</b>	Confirmation of SPAIN Values.	EIM (ADIF)	Add line information for NID_C=355 and 370.	
<b>13/05/07</b>	Confirmation of use for NID_ENGINE value 1024.	UNISIG	Keep '1024' for FS.	

**ERA ERTMS UNIT**

**ASSIGNMENT OF VALUES TO ETCS VARIABLES**

<b>Date of modification</b>	<b>Questions / Remarks</b>	<b>From</b>	<b>Decision</b>	<b>Supporting documents</b>
<b>02/05/07</b>	Explanation for avoiding deletion of NID_STM value 21	UNISIG	For the moment there is no need to have a specific NID for such STM group because a train equipped with a bi-standard (ETCS + STM TVM) equipment is able to run on any line equipped with TVM. The decision is to remove the value '21' until someone requires such use.	 NID_STM_21__STM_WG_answer.doc
<b>01/05/07</b>	Request for assigning an NID_C value for Australian line New South Wales	SIEMENS	Value '540' decimal is assigned	
<b>26/04/07</b>	1) please replace generally Alcatel by Thales  2) NID_STM: please add Thales in the column "Confirmed by" for the following values: 6, 10, 17	THALES	1) and 2) Agreed	
<b>02/04/07</b>	NID_ENGINE for SNCF : from 2097152 to 2162687	SNCF	Values confirmed instead of reserved	
<b>28/03/07</b>	Final Contribution of BOMBARDIER	UNISIG	NID_C, NID_ENGINE, NID_STM, NID-XUSER modified as requested in the supporting document with a confirmation needed for value '1024' of NID_ENGINE.	 ERA_ERTMS_0061_v1.0_ETCS Variables B
<b>19/03/07</b>	Request for an additional value for NID_C for Greece.	EDISY S.A.	Assignment of NID_C='474' for the line "Pireaus – Athens – Three Bridges."	
<b>13/03/07</b>	* STM number 21 is not used by France. * for STM number 11 there is a mistake because it cannot be KVB for Italy  * There are still in M_TRACTION the values 1 and 2 that are reserved for France (reserved range from 1 to 5), ALSTOM and ANSALDO have to take the values for Switzerland and Italy inside their proper range already reserved for these countries.	RFF	* Reference to France for NID_STM=21 removed * NID_STM=11 is assigned for SCMT instead of KVB * M_TRACTION management is still under discussion in the context for base lining SRS 3.0.0	
<b>23/02/07</b>	Request NID_C=0 for test purposes	SIEMENS	Do not assign NID_C=0 to any country.	



## ERA ERTMS UNIT

### ASSIGNMENT OF VALUES TO ETCS VARIABLES

---

Date of modification	Questions / Remarks	From	Decision	Supporting documents
13/02/07	Request for M_TRACTION values.	ZSR	Decimal values 66 to 70 have been reserved to Slovakia.	
12/02/07	Confirmation for not use of NC_DIFF=0	ALSTOM	NC_DIFF updated accordingly	



**A.3 STATISTICS ABOUT THE USE OF THE VARIABLES**

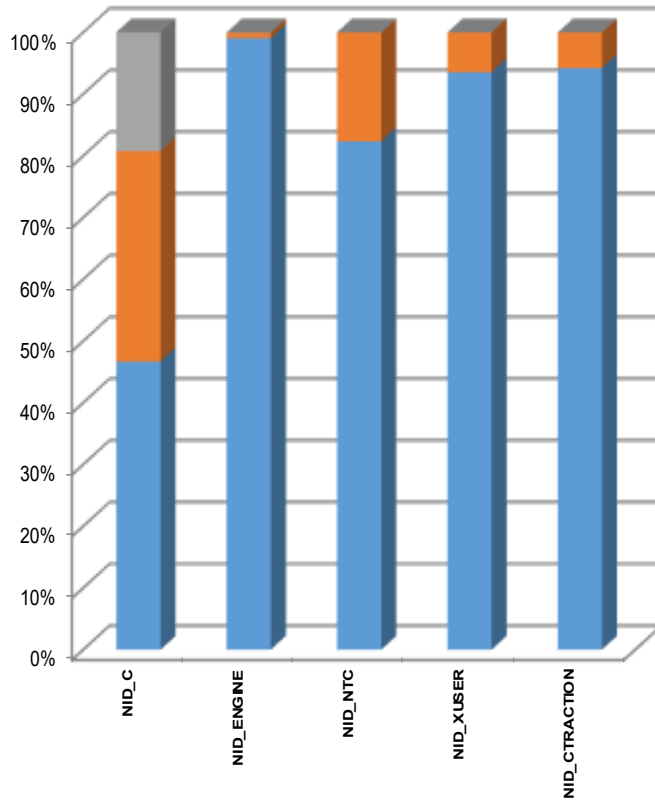

	Free	Allocated	Reserved
NID_C	478	349	197
NID_ENGINE	16623286	146345	7585
NID_NTC	210	45	0
NID_XUSER	479	33	0
NID_CTRACTION	964	59	0

**A.4 REQUEST FORM FOR THE ASSIGNMENT OF VALUES**

<p>ASSIGNMENT OF VALUES TO ETCS VARIABLES</p>
<p>REQUEST FORM</p>

Please fill all the fields in the three sections of the form and send it at the following address:  
[request.etcs\\_variables@era.europa.eu](mailto:request.etcs_variables@era.europa.eu)

1/ Date of Submission: ...

2/ Information about the submitter:

<i>Name:</i>	.....
<i>Organization:</i>	.....
<i>Position:</i>	.....
<i>Address:</i>	.....
<i>City:</i>	.....
<i>Country:</i>	.....
<i>Phone:</i>	.....
<i>E-mail:</i>	.....

**ERA ERTMS UNIT**

**ASSIGNMENT OF VALUES TO ETCS VARIABLES**

---

**3/ Information about the request:**

<p><i>Name of the ETCS variable:</i></p>	<p>.....</p>
<p><i>Reason of the request:</i></p>	<p><i>Please indicate if this request is either:</i></p> <ul style="list-style-type: none"> <li>- for a first assignment of value or,</li> <li>- for an extension of a previous assignment to the same variable by the same organisation or,</li> <li>- for an update of the definition or,</li> <li>- for a release of a previous assignment or,</li> <li>- for a transfer of responsibility to another entity <sup>(*)</sup>.</li> </ul> <p>.....</p>
<p><i>Justification:</i></p>	<p><i>In case of an extension indicate why the previous assignment is not sufficient, in case of a release indicate the circumstances:</i></p> <p>.....</p>
<p><i>Requested value(s)</i></p>	<p><i>If the request relates to a preferred value or range of values, write it here:</i></p> <p>.....</p>
<p><i>Definition of value(s)</i></p>	<p><i>Give the definition that will correspond to the value(s) as it will be written down in the ERA listing of values:</i></p> <p>.....</p>
<p><i>References:</i></p>	<p><i>Indicate the reference to real planned project(s) or reference to awarded contracts this request is related to:</i></p> <p>.....</p>

<sup>(\*)</sup>: In this specific case, the current request shall also be accompanied by a request filled by the accepting entity which hands over the full responsibility for the use of the related variables.

**A.5 SPECIFIC ADDITIONAL FORM(S)**

**A.5.1 NID\_CTRACTION**

Please fill in the form below enabling to identify the different traction systems. The country identifier is expected to identify unambiguously the traction system, through the country/region, the voltage, and the line(s) where the traction system is installed and if necessary some other parameter(s) from the Infrastructure register (e.g. “France/25 kV/High speed lines”, “25 kV/Eurotunnel”, “Germany/15 kV/max train current 600 A” ...).

Country identifier of the traction system (will be published as description of the allocated value of NID_CTRACTION)	<i>Fill here the identifier of the traction system 1</i>	<i>Fill here the identifier of the traction system 2</i>	.....	<i>Fill here the identifier of the traction system n</i>
Parameter # (refer to annex A.5.1.1)	Traction system 1 list of parameters	Traction system 2 list of parameters	.....	Traction system n list of parameters
1	<i>Fill here the value of the parameter 1</i>			
2	.....			
3				
4				
5				
6				
7				
8				
9				
10				
11				
12				
13				
14				
15				

## ERA ERTMS UNIT

### ASSIGNMENT OF VALUES TO ETCS VARIABLES

#### A.5.1.1

#### EXTRACT FROM THE INFRASTRUCTURE INTEROPERABILITY REGISTER

Parameter #	Overhead contact line		
1	Energy supply system (Voltage and frequency)	[Character String] single selection from the predefined list: not electrified/ AC 25kV-50Hz/ AC 15kV-16.7Hz/ DC 3kV/ DC 1.5kV/ DC (Specific Case FR)/ DC 750V/ other (specify nominal voltage and frequency and ranges)	Nominal voltage and frequency if according to EN 50163:2004. If range of the EN is exceeded, maximum permanent voltage value to be published (maximum value given in brackets).
2	Maximum train current	[NNNN]	The maximum allowable train current expressed in amperes (A).
3	Maximum current at standstill per pantograph	[NNN]	The maximum allowable train current at standstill for DC systems expressed in amperes (A).
4	Existence of permission for regenerative braking	[Y/N]	Regenerative braking is permitted or not.
5	Nominal contact wire height	[N.NN]	Nominal value of the contact wire height at a support in the normal conditions expressed in meter.
6	Maximum contact wire height	[N.NN]	Maximum value of the contact wire height at a support in the normal conditions expressed in meter.
7	<i>Minimum contact wire height</i>	[N.NN]	Minimum value of the contact wire height at a support in the normal conditions expressed in meter.
Parameter #	Pantograph		
8	Accepted pantograph heads	[Character String] multiple choice from the predefined list: 1950mm(Type1)/ 1950mm(Type2)/ 1950mm(PL)/ 1800mm(NO,SE)/ 1600mm(EP)/ 1600mm(GB,CTRL)/ 1600mm(GB)/ 1450/ others (specify)	One or more pantograph heads according to RST TSI or EN 50367:2006.

## ERA ERTMS UNIT

### ASSIGNMENT OF VALUES TO ETCS VARIABLES

9	Requirements for number of raised pantographs and spacing between them	[Character String]	Maximum number of raised pantographs allowed on the line. Minimum spacing centre line to centre line of the pantograph head in case of two or more pantographs raised, expressed in meters. Values are defined for the 'maximum permitted speed' on the section.
10	Permitted contact strip material	[Character String] multiple choice from the predefined list: Copper/plain carbon/carbon with additive material/carbon with cladded copper/others	One or more types of contact strip material allowed to be used on the line.
<b>Parameter #</b>	<b>OCL separation sections</b>		
11	Existence of phase separation	[Y + link/N]	In case of existence of phase separation on the section of the line, a link to a detailed description shall be given.
12	Existence of system separation	[Y + link/N]	In case of existence of system separation on the section of the line, a link to a detailed description shall be given.
<b>Parameter #</b>	<b>Requirements for rolling stock</b>		
13	Current limitation on board required	[Y/N]	Requirement for an on-board device allowing to set the maximum train current
14	Mean contact force permitted	[Character String] or [NNN]	Mean contact force allowed on the line. The force is either given as a predefined curve or a value expressed in Newton.
15	Automatic dropping device (ADD) required	[Y/N]	Automatic dropping device (ADD) required on the vehicle, according to EN 50206-1.

## ERA ERTMS UNIT

### ASSIGNMENT OF VALUES TO ETCS VARIABLES

#### A.6 FROZEN LISTS OF VALUES

##### A.6.1 M\_TRACTION

Values	Country/ Regions	Description
0	All	Non electrical traction
1	Italy	3kV DC
2	France	25kV AC 50Hz conventional lines
3	France	25kV AC 50Hz high speed lines
4	Eurotunnel	25kV AC 50Hz Eurotunnel
5	France	1.5kV DC
6	Netherlands	1.5kV DC
7	Netherlands	25kV AC 50Hz conventional lines
8	Netherlands	25kV AC 50Hz high speed lines
11	Germany	15kV AC 16.7Hz, max. train current 600 A
12	Germany	15kV AC 16.7Hz, max. train current 780 A
13	Germany	15kV AC 16.7Hz, max. train current 900 A
14	Germany	15kV AC 16.7Hz, max. train current 1000 A
15	Germany	15kV AC 16.7Hz, max. train current 1500 A
16	Belgium	3kV DC
17	Belgium	25kV AC 50Hz L1
18	Belgium	25kV AC 50Hz L2L3L4
19	Belgium	25kV AC 50Hz CR
21	Luxembourg	25kV AC 50Hz
26	Italy	25kV AC 50Hz
31	Spain	25kV AC 50Hz high speed lines 1600 mm
32	Spain	3kV DC conventional lines 220 km/h max. line speed
33	Spain	3kV DC conventional lines 160 km/h max. line speed
34	Spain	25kV AC 50Hz high speed lines 1600/1950 mm
41	Switzerland	15kV AC 16.7Hz, 1320/1450 mm
42	Switzerland	15kV AC 16.7Hz, 1450/1600 mm
43	Switzerland	15kV AC 16.7Hz, 1950 mm
44	Switzerland	15kV AC 16.7Hz, 1320/1450/1600 mm
45	Switzerland	15kV AC 16.7Hz, 1450/1600/1950 mm
46	Switzerland	15kV AC 16.7Hz, 1320/1450/1600/1950 mm
51	Austria	15 kV, 16,67 Hz, 1950 mm
53	Austria	25kV 50 Hz
61	Sweden	15kV AC 16.7Hz, max. 900 A
66	Slovakia	3kV DC
67	Slovakia	25kV AC 50Hz
71	Croatia	3kV DC
72	Croatia	25kV AC 50Hz
129	Czech Rep.	25kV AC 50Hz
130	Czech Rep.	3kV DC
131	Czech Rep.	15kV AC 16.7Hz
201	New Zealand	25kV AC 50Hz
202	New Zealand	1.5kV DC

## ERA ERTMS UNIT

### ASSIGNMENT OF VALUES TO ETCS VARIABLES

#### A.6.2 NC\_TRAIN: INTERNATIONAL CATEGORY TO WHICH BELONGS THE TRAIN

International train category number	Bit Values	Definition [criterion]	Corresponding value for criterion
1	xxx xxxx xxxx xxx1	Permissible cant deficiency [Criterion cd <sub>adm</sub> in EN14363:2005]	275 mm
2	xxx xxxx xxxx xx1x	Permissible cant deficiency [Criterion cd <sub>adm</sub> in EN14363:2005]	80 mm
3	xxx xxxx xxxx x1xx	Permissible cant deficiency [Criterion cd <sub>adm</sub> in EN14363:2005]	100 mm
4	xxx xxxx xxxx 1xxx	Permissible cant deficiency [Criterion cd <sub>adm</sub> in EN14363:2005]	130 mm
5	xxx xxxx xxx1 xxxx	Permissible cant deficiency [Criterion cd <sub>adm</sub> in EN14363:2005]	150 mm
6	xxx xxxx xx1x xxxx	Permissible cant deficiency [Criterion cd <sub>adm</sub> in EN14363:2005]	165 mm
7	xxx xxxx x1xx xxxx	Permissible cant deficiency [Criterion cd <sub>adm</sub> in EN14363:2005]	180 mm
8	xxx xxxx 1xxx xxxx	Permissible cant deficiency [Criterion cd <sub>adm</sub> in EN14363:2005]	225 mm
9	xxx xxx1 xxxx xxxx	Permissible cant deficiency [Criterion cd <sub>adm</sub> in EN14363:2005]	300 mm
10	xxx xx1x xxxx xxxx	Freight train braked in "P" position	Freight P
11	xxx x1xx xxxx xxxx	Freight train braked in "G" position	Freight G
12	xxx 1xxx xxxx xxxx	Passenger train	Passenger
13	xx1 xxxx xxxx xxxx	Permissible cant deficiency [Criterion cd <sub>adm</sub> in EN14363:2005]	245 mm
14	x1x xxxx xxxx xxxx	Permissible cant deficiency [Criterion cd <sub>adm</sub> in EN14363:2005]	210 mm
15	1xx xxxx xxxx xxxx	This value shall never be used	N/A

#### A.6.3 Q\_TEXT



## ERA ERTMS UNIT

### ASSIGNMENT OF VALUES TO ETCS VARIABLES

---

Values	Country/ Regions	Description
Not Applicable	Not Applicable	Not Applicable

Note: the variable remains empty

**A.6.4 M\_LOADINGGAUGE (AS PART OF TRAIN DATA): LOAD PROFILE**

Values	Country/ Regions	Description
0		Value used to define that no loading gauge are defined for the train.

Note: the variable shall not be used by the trackside

**A.7 DETAILED DESCRIPTION OF THE TRACTION SYSTEMS DEFINED BY NID\_CTRACTION**

The definition of the parameters is given in the Annex A.5.1.1.

	NID_CTRACTION = 1 Netherlands 1.5kV DC	NID_CTRACTION = 2 Netherlands 25kV 50Hz Conventional lines	NID_CTRACTION = 3 Netherlands 25kV 50Hz High speed lines
Parameter	list of requirements	list of requirements	list of requirements
1	1.5kV DC	25kV AC 50Hz	25kV AC 50Hz
2	4000 A	500 A	800 A
3	300 A	N/A	N/A
4	Y	Y	Y
5	5.50 m	5.50 m	5.50 m
6	5.75 m	5.80 m	5.80 m
7	4.90 m	5.20 m	5.20 m
8	1950 mm type 1	<ul style="list-style-type: none"> <li>1950 mm type 1</li> <li>1600 mm figure A7</li> </ul>	<ul style="list-style-type: none"> <li>1950 mm type 1</li> <li>1600 mm figure A7</li> </ul>
9	2, pantograph spacing according to TSI ENE CR (2011/274/EU) table 4.2.17 category A	1	2, 400 m
10	Plain Carbon Metallised Carbon	Plain Carbon Metallised Carbon	Plain Carbon Metallised Carbon
11	N	Y, ROI	Y, ROI
12	N/A	Y, ROI	Y, ROI
13	Y	Y	Y
14	170 N $F_{m,max} < 0.00097 v^2 + 140N$	<100 N $F_{m,max} < 0.00047 v^2 + 90N$	<100 N $F_{m,max} < 0.00047 v^2 + 90N$
15	N	N	Y

ROI : Register Of Infrastructure

## ERA ERTMS UNIT

### ASSIGNMENT OF VALUES TO ETCS VARIABLES

	NID_CTRACTION = 4 Switzerland 15kV AC 16.7Hz 1320/1450 mm	NID_CTRACTION = 5 Switzerland 15kV AC 16.7Hz 1450/1600 mm	NID_CTRACTION = 6 Switzerland 15kV AC 16.7Hz 1950 mm
Parameter	list of requirements	list of requirements	list of requirements
1	15kV AC 16.7Hz	15kV AC 16.7Hz	15kV AC 16.7Hz
2	900 A	900 A	900 A
3	N/A	N/A	N/A
4	Y	Y	Y
5	5.30 m	5.30 m	5.30 m
6	6.00 m	6.00 m	6.00 m
7	4.80 m	4.80 m	4.80 m
8	1320 mm (historic trains), 1450 mm (with isolated horns)	1450 mm (with isolated horns), 1600 mm (EP)	1950 mm (Type1 and Type2)
9	Maximum number of raised pantographs: 6; Minimum spacing: 13 m	Maximum number of raised pantographs: 6; Minimum spacing: 13 m	Maximum number of raised pantographs: 6; Minimum spacing: 13 m
10	plain carbon carbon with cladded copper carbon with additive material	plain carbon carbon with cladded copper carbon with additive material	plain carbon carbon with cladded copper carbon with additive material
11	Y (according to EN 50367)	Y (according to EN 50367)	Y (according to EN 50367)
12	Y (according to EN 50367)	Y (according to EN 50367)	Y (according to EN 50367)
13	Y	Y	Y
14	C curve: $F_m = 0.00097 \times v^2 + 70$ (according to EN 50367)	C curve: $F_m = 0.00097 \times v^2 + 70$ (according to EN 50367)	C curve: $F_m = 0.00097 \times v^2 + 70$ (according to EN 50367)
15	Y	Y	Y

## ERA ERTMS UNIT

### ASSIGNMENT OF VALUES TO ETCS VARIABLES

	NID_CTRACTION = 7 Switzerland 15kV AC 16.7Hz 1320/1450/1600 mm	NID_CTRACTION = 8 Switzerland 15kV AC 16.7Hz 1450/1600/1950 mm	NID_CTRACTION = 9 Switzerland 15kV AC 16.7Hz 1320/1450/1600/1950 mm
Parameter	list of requirements	list of requirements	list of requirements
1	15kV AC 16.7Hz	15kV AC 16.7Hz	15kV AC 16.7Hz
2	900 A	900 A	900 A
3	N/A	N/A	N/A
4	Y	Y	Y
5	5.30 m	5.30 m	5.30 m
6	6.00 m	6.00 m	6.00 m
7	4.80 m	4.80 m	4.80 m
8	1320 mm (historic trains), 1450 mm (with isolated horns), 1600 mm (EP)	1450 mm (with isolated horns), 1600 mm (EP), 1950 mm (Type1 and Type2)	1320 mm (historic trains), 1450 mm (with isolated horns), 1600 mm (EP), 1950 mm (Type1 and Type2)
9	Maximum number of raised pantographs: 6; Minimum spacing: 13 m	Maximum number of raised pantographs: 6; Minimum spacing: 13 m	Maximum number of raised pantographs: 6; Minimum spacing: 13 m
10	plain carbon carbon with cladded copper carbon with additive material	plain carbon carbon with cladded copper carbon with additive material	plain carbon carbon with cladded copper carbon with additive material
11	Y (according to EN 50367)	Y (according to EN 50367)	Y (according to EN 50367)
12	Y (according to EN 50367)	Y (according to EN 50367)	Y (according to EN 50367)
13	Y	Y	Y
14	C curve: $F_m = 0.00097 \times v^2 + 70$ (according to EN 50367)	C curve: $F_m = 0.00097 \times v^2 + 70$ (according to EN 50367)	C curve: $F_m = 0.00097 \times v^2 + 70$ (according to EN 50367)
15	Y	Y	Y

## ERA ERTMS UNIT

### ASSIGNMENT OF VALUES TO ETCS VARIABLES

	NID_CTRACTION = 10 Italy 3kV DC	NID_CTRACTION = 11 Italy 25kV AC 50Hz
Parameter	list of requirements	list of requirements
1	3kV DC	25kV AC 50Hz
2	2400 A	600 A
3	200 A	N/A
4	Y	Y
5	5.20 m	5.30 m
6	6.00 m	5.60 m
7	4.80 m	5.20 m
8	1600 - 1450 mm	1600 - 1450 mm
9	200 m	N/A
10	carbon with clad copper	carbon
11	N	Y  The principle scheme is the same shown in figure A.5 of the annex A.1.5 of EN 50367.
12	N	Y  Trains will pass through system separation section with pantograph lowered, not touching the overhead contact line. A protection system is also installed in order to avoid unintentionally raised pantographs.
13	N	N
14	curve CC of HS TSI Energy	curve C of HS TSI Energy
15	Y	Y

## ERA ERTMS UNIT

### ASSIGNMENT OF VALUES TO ETCS VARIABLES

	NID_CTRACTION = 12 France 25kV AC 50Hz conventional lines	NID_CTRACTION = 13 France 25kV AC 50Hz high speed lines	NID_CTRACTION = 14 France 1.5kV DC
Parameter	list of requirements	list of requirements	list of requirements
1	25kV AC 50Hz	25kV AC 50Hz	1.5kV DC
2	400 A	500 A	5000 A
3	N/A	N/A	300 A
4	Y (If available)	Y (If available)	Y (If available)
5	5.50 m	5.08 m	5.50 m
6	6.02 m	5.08 m	6.30 m
7	4.59 m	5.08 m	4.47 m
8	EN50367 A6, B1, B3	EN50367 A6, B1, B3	EN50367 A7, B2, B3, B4
9	Spacing requirements specified in figure 1	Spacing requirements specified in figure 1	No specific requirement
10	Plain carbon Metallic carbon	Plain carbon Metallic carbon	Copper alloy (steel) Copper carbon Coated carbon
11	Yes, see figure 3, figure 4 and figure 5	Yes, see figure 3, figure 4 and figure 5	No
12	Yes, see figure 6 and figure 7	Yes, see figure 6 and figure 7	Yes, see figure 6 and figure 7
13	No	No	NO
14	< 120 for V < 160 < 150 for 160 < V ≤ 200	See figure 2 below	< 120 for V < 160 < 150 for 160 < V ≤ 200
15	No	Yes	No

ASSIGNMENT OF VALUES TO ETCS VARIABLES

The distances to be respected to allow the crossing of the phase separation sections in 25kV with raised pantographs and no power are specified in the table below

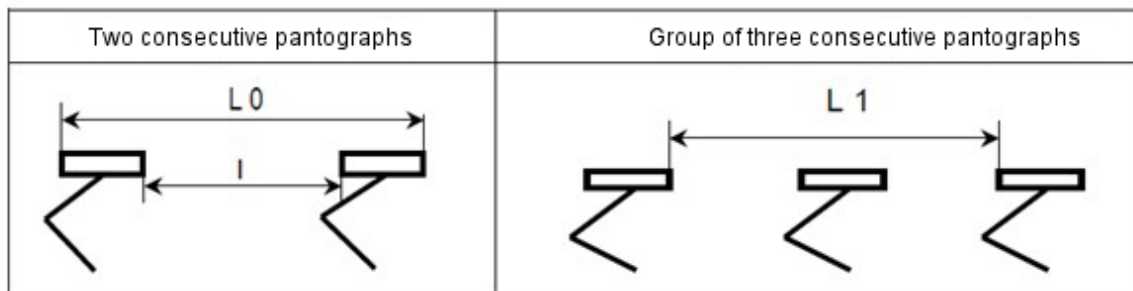

Type of lines	Number of neutral section	Type of phase separation sections	Distances to be respected (m)	
			Consecutive pantographs electrically coupled	Consecutive pantographs not electrically coupled
Conventional lines	1 neutral section		$L_0 < 29$	$L_0 < 29$ ou $l > 74$
	2 neutral sections*		$L_0 < 22$	$L_1 \geq 80$
High speed lines	1 neutral section		$L_0 < 12$	$L_0 < 12$ ou $l > 152$
	2 neutral sections*		$L_0 < 40$	$L_1 \geq 143$

Bypass zone of two adjacent catenaries by pantograph head

\* This kind of phase separation section is not generalized on French Network but depends on the line.

Figure 1: distance between pantographs on 25kV

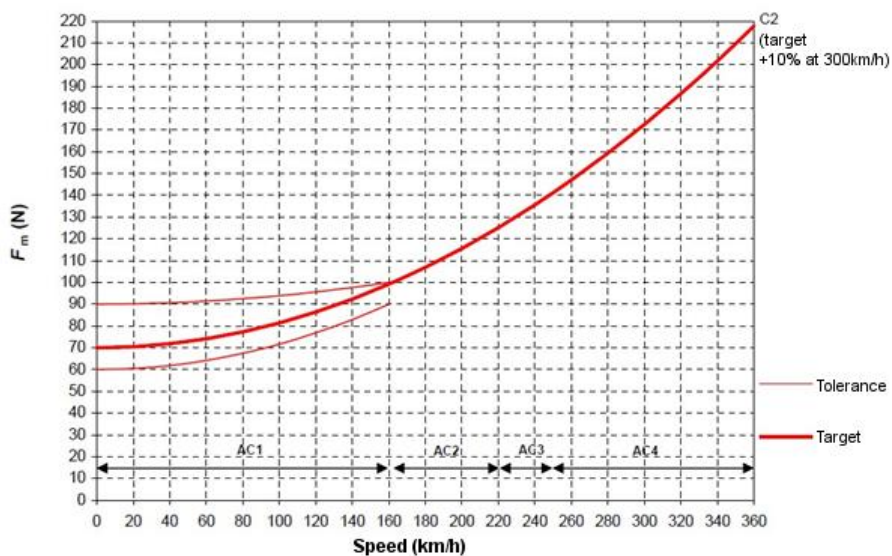
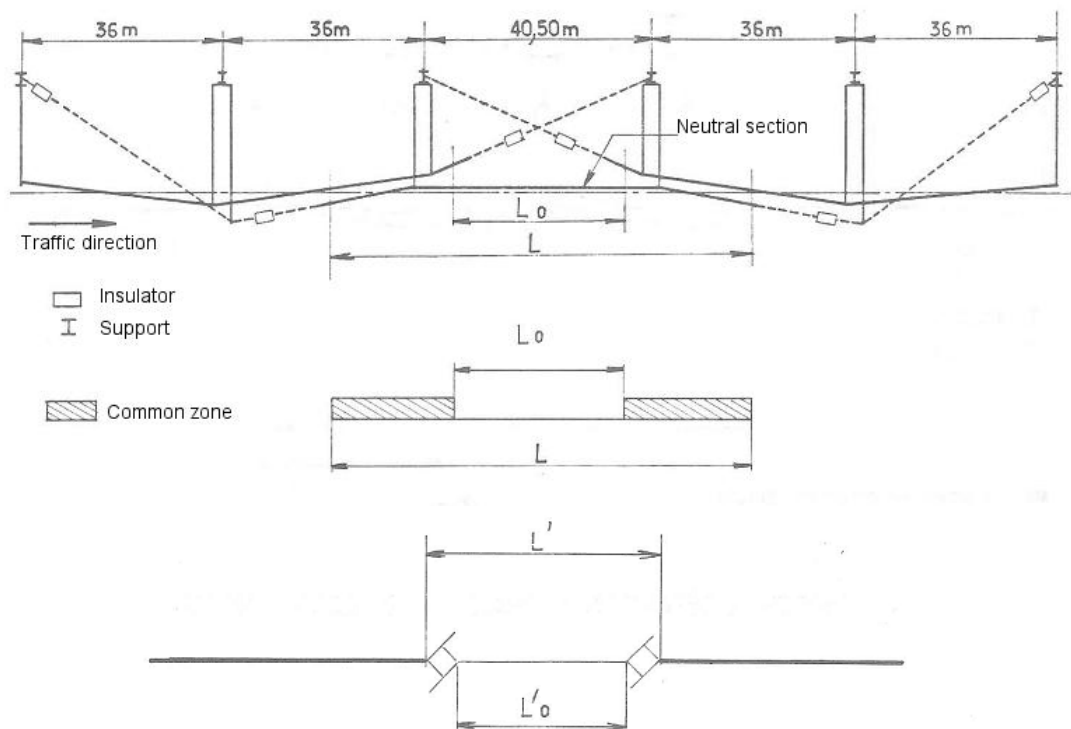

Figure 2: Mean contact force permitted  $F_m$  (+10%) depending on speed



1. Example with sectioning



2. Example with section insulators

Figure 3: Phase separation sections with one neutral section

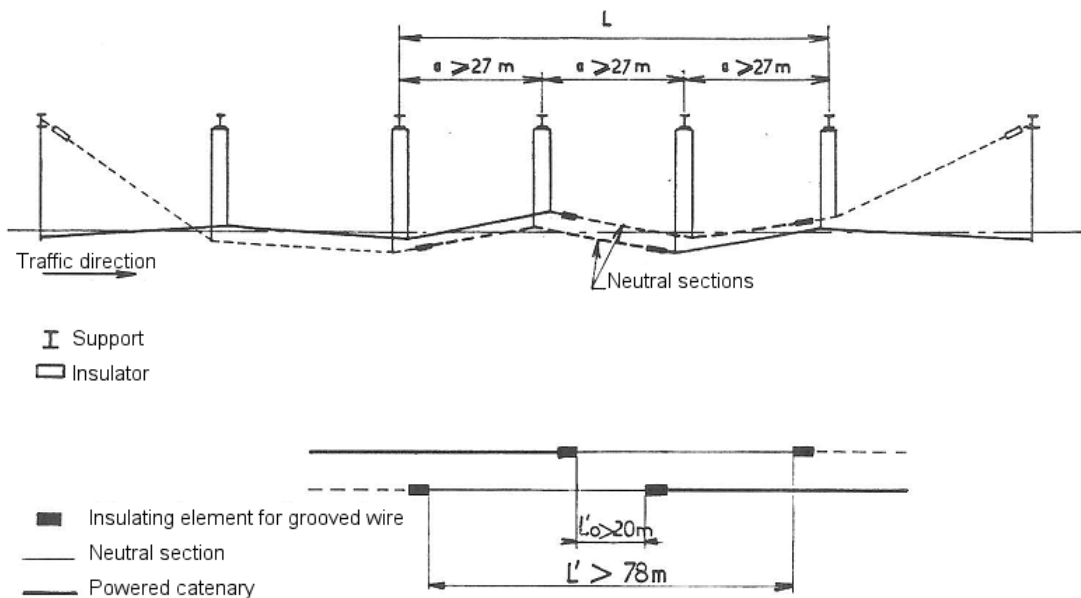

Figure 4: Phase separation sections with two neutral sections

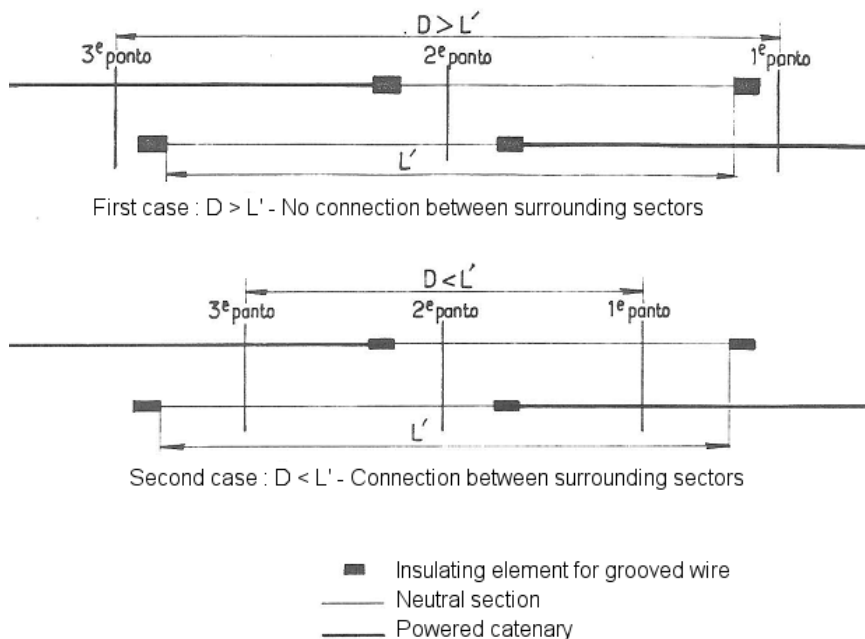

Figure 5: Separation section with two neutral sections crossed by three pantographs not electrically coupled

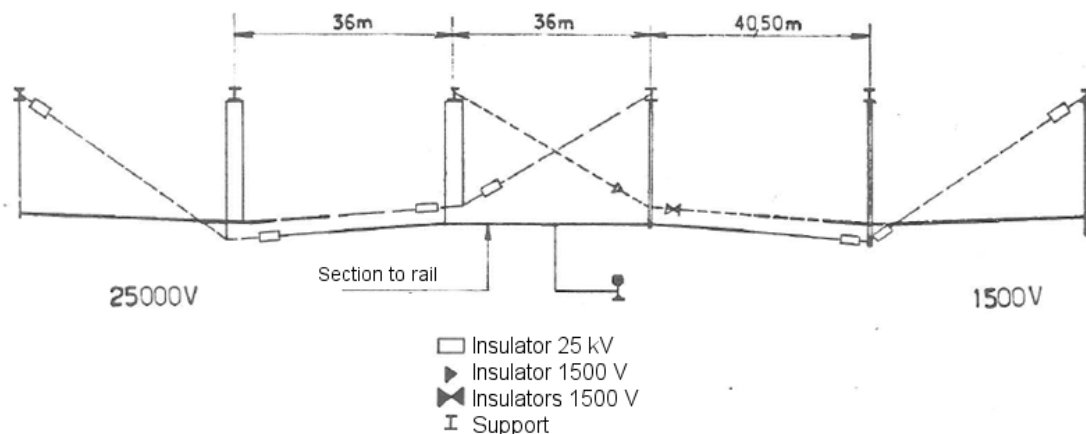

Figure 6: System separation 1500V/25kV with one section connected to the rail

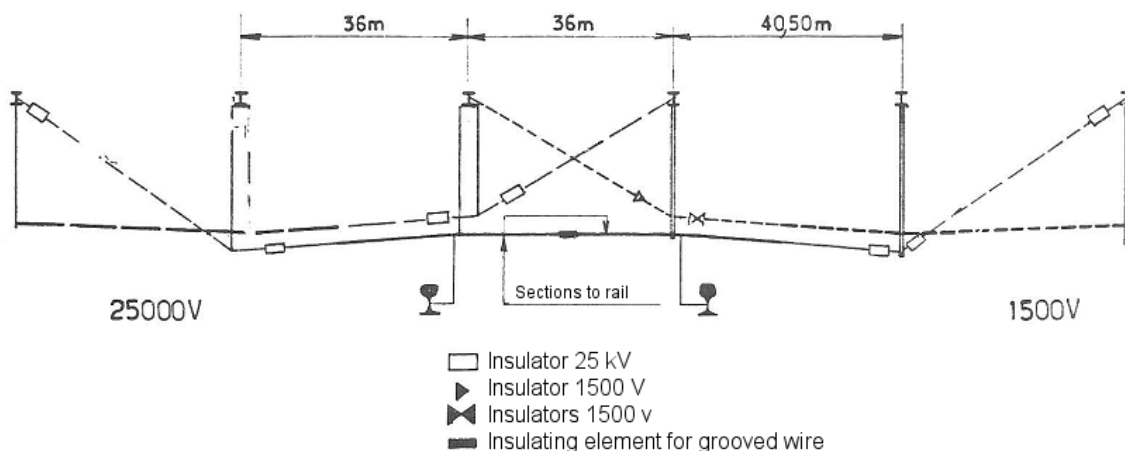

Figure 7: System separation 1500V/25kV with two sections connected to the rail

## ERA ERTMS UNIT

### ASSIGNMENT OF VALUES TO ETCS VARIABLES

Parameter	list of requirements	list of requirements
	NID_CTRACTION = 15 Spain 3kV DC conventional lines 220 km/h max. line speed	NID_CTRACTION = 16 Spain 3kV DC conventional lines 160 km/h max. line speed
1	3kV DC	3kV DC
2	3200 A	2500 A
3	200 A	200 A
4	Y	Y
5	5.30 m	5.30 m
6	6.00 m	6.00 m
7	4.60 m	4.60 m
8	1950 mm	1950 mm
9	1 (exceptionally 2)	1 (exceptionally 2)
10	Cu ETP Exceptionally Cu Zn Cr	Cu ETP Exceptionally Cu Zn Cr
11	N/A	N/A
12	Y, see figure 2.  Additional measures on current return circuit according to EN 50122-2, section 6.1.1.  Trains will pass through phase separation section with pantograph lowered and main circuit breaker opened, not touching the overhead contact line.	Y, see figure 2.  Additional measures on current return circuit according to EN 50122-2, section 6.1.1.  Trains will pass through phase separation section with pantograph lowered and main circuit breaker opened, not touching the overhead contact line.
13	N	N
14	$90 \text{ N} < F_m < 0.00097 \times v^2 + 110 \text{ N}$ [F <sub>m</sub> ]=Mean contact force in N [v]=speed in km/h	$90 \text{ N} < F_m < 0.00097 \times v^2 + 110 \text{ N}$ [F <sub>m</sub> ]=Mean contact force in N [v]=speed in km/h
15	N	N

## ERA ERTMS UNIT

### ASSIGNMENT OF VALUES TO ETCS VARIABLES

Parameter	list of requirements	list of requirements
	NID_CTRACTION = 17 Spain 25kV AC 50Hz high speed lines 1600/1950 mm	NID_CTRACTION = 18 Spain 25kV AC 50Hz high speed lines 1600 mm
1	25kV AC 50Hz	25kV AC 50Hz
2	1500 A	1500 A
3	N/A	N/A
4	Y	Y
5	5.30 m	5.30 m
6	6.00 m	6.00 m
7	4.95 m	4.95 m
8	1600 mm, 1950 mm (max 220 km/h)	1600 mm
9	2 - 200 m	2 - 200 m
10	Plain carbon (Graphite)	Plain carbon (Graphite)
11	Yes, figures 1 and 3	Yes, figures 1 and 3
12	Y, see figure 2.  Additional measures on current return circuit according to EN 50122-2, section 6.1.1.  Trains will pass through phase separation section with pantograph lowered and main circuit breaker opened, not touching the overhead contact line.	Y, see figure 2.  Additional measures on current return circuit according to EN 50122-2, section 6.1.1.  Trains will pass through phase separation section with pantograph lowered and main circuit breaker opened, not touching the overhead contact line.
13	Y	Y
14	C2 curve: $F_m = 0.001145 \times v^2 + 70$ C curve: $F_m = 0.00097 \times v^2 + 70$ C1 curve: $F_m = 0.000795 \times v^2 + 70$ [F <sub>m</sub> ] = Mean contact force in N [v] = speed in km/h	C2 curve: $F_m = 0.001145 \times v^2 + 70$ C curve: $F_m = 0.00097 \times v^2 + 70$ C1 curve: $F_m = 0.000795 \times v^2 + 70$ [F <sub>m</sub> ] = Mean contact force in N [v] = speed in km/h
15	Y	Y

Figure 1: Phase separation section

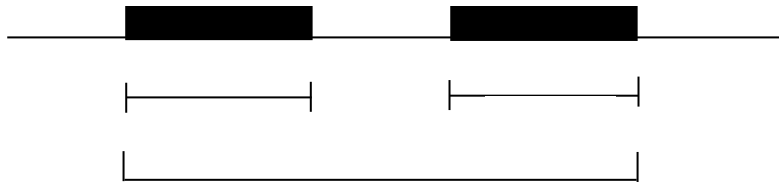
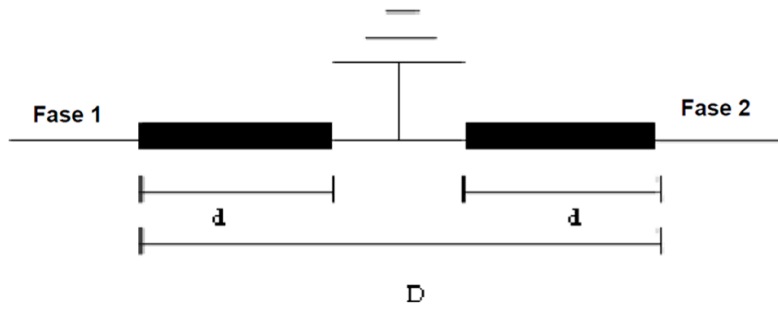
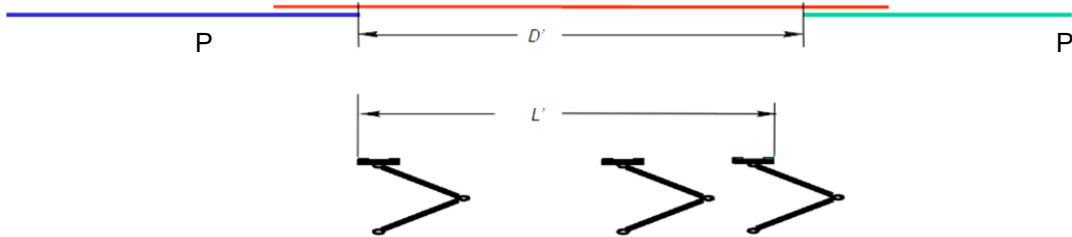

Figure 2: System separation section with neutral section insulators



Conditions:  $D \leq 8 \text{ m}$   
 $d = f$  (system voltage, maximum speed of the line, maximum width of pantograph)

Figure 3: Divided neutral section



Conditions:  $L' < 400 \text{ m}$   
 $D' > 402 \text{ m}$

## ERA ERTMS UNIT

### ASSIGNMENT OF VALUES TO ETCS VARIABLES

Parameter	list of requirements	list of requirements
	NID_CTRACTION = 19 Germany 15kV AC 16.7Hz max. train current 600 A	NID_CTRACTION = 20 Germany 15kV AC 16.7Hz max. train current 780 A
1	15KV AC 16.7 Hz	15KV AC 16.7 Hz
2	600 A	780 A
3	N/A	N/A
4	Y	Y
5	5.50 m Cat II-VII	5.50 m Cat II-VII
6	6.20 m Cat II-VII	6.20 m Cat II-VII
7	4.950 m Cat II-VII	4.950 m Cat II-VII
8	1950 mm (type 1)	1950 mm (type 1)
9	2 pantographs Type A, min. spacing : 200 m (160 km/h < v), 85 m (120 < v ≤ 160 km/h), 20 m (80 < v ≤ 120 km/h), 8 m (v ≤ 80 km/h)	2 pantographs Type A, min. spacing : 200 m (160 km/h < v), 85 m (120 < v ≤ 160 km/h), 20 m (80 < v ≤ 120 km/h), 8 m (v ≤ 80 km/h)
10	plain carbon, carbon with additive material	plain carbon, carbon with additive material
11	Y (contact: joertis.winkel@deutscheba hn.com)	Y (contact: joertis.winkel@deutscheba hn.com)
12	Y (at borders on a bilateral basis; contact: joertis.winkel@deutscheba hn.com)	Y (at borders on a bilateral basis; contact: joertis.winkel@deutscheba hn.com)
13	Y (According to EN 50388)	Y (According to EN 50388)
14	C curve: v ≤ 200 km/h: 60 N < Fm < 0.00047 x v <sup>2</sup> + 90; 200 km/h < v: Fm = 0.000795 x v <sup>2</sup> + 70	C curve: v ≤ 200 km/h: 60 N < Fm < 0.00047 x v <sup>2</sup> + 90; 200 km/h < v: Fm = 0.000795 x v <sup>2</sup> + 70
15	Y (mandatory)	Y (mandatory)

## ERA ERTMS UNIT

### ASSIGNMENT OF VALUES TO ETCS VARIABLES

	NID_CTRACTION = 21 Germany 15kV AC 16.7Hz max. train current 900 A	NID_CTRACTION = 22 Germany 15kV AC 16.7Hz max. train current 1500 A
Parameter	list of requirements	list of requirements
1	15KV AC 16.7 Hz	15KV AC 16.7 Hz
2	900 A	1500 A
3	N/A	N/A
4	Y	Y
5	5.50 m Cat II-VII	5.50 m Cat II-VII
6	6.20 m Cat II-VII	6.20 m Cat II-VII
7	4.950 m Cat II-VII	4.950 m Cat II-VII
8	1950 mm (type 1)	1950 mm (type 1)
9	2 pantographs Type A, min. spacing : 200 m (160 km/h < v), 85 m (120 < v ≤ 160 km/h), 20 m (80 < v ≤ 120 km/h), 8 m (v ≤ 80 km/h)	2 pantographs Type A, min. spacing : 200 m (160 km/h < v), 85 m (120 < v ≤ 160 km/h), 20 m (80 < v ≤ 120 km/h), 8 m (v ≤ 80 km/h)
10	plain carbon, carbon with additive material	plain carbon, carbon with additive material
11	Y (contact: joertis.winkel@deutschebah n.com)	Y (contact: joertis.winkel@deutschebah n.com)
12	Y (at borders on a bilateral basis; contact: joertis.winkel@deutschebah n.com)	Y (at borders on a bilateral basis; contact: joertis.winkel@deutschebah n.com)
13	Y (According to EN 50388)	Y (According to EN 50388)
14	C curve: $v \leq 200 \text{ km/h}: 60 \text{ N} < F_m < 0.00047 \times v^2 + 90;$ $200 \text{ km/h} < v: F_m = 0.000795 \times v^2 + 70$	C curve: $v \leq 200 \text{ km/h}: 60 \text{ N} < F_m < 0.00047 \times v^2 + 90;$ $200 \text{ km/h} < v: F_m = 0.000795 \times v^2 + 70$
15	Y (mandatory)	Y (mandatory)

## ERA ERTMS UNIT

### ASSIGNMENT OF VALUES TO ETCS VARIABLES

	NID_CTRACTION = 23 Slovenia 3kV DC	NID_CTRACTION = 24 Denmark, conventional lines 160/200 km/h, 25kV AC 50 Hz	NID_CTRACTION = 27 Finland 25kV AC
Parameter	list of requirements	list of requirements	list of requirements
1	3kV DC	AC 25kV-50Hz	AC 25kV-50Hz AC 2x25kV
2	2800 A	500 A	500 A
3	200 A	N/A	N
4	Y	Y	Y
5	5.35 m	5.50 m	6.15m
6	6.20 m	6.00 m	6.50m
7	4.95 m	4.91 m	5.60m
8	1450 mm EN 50367:2006 Figure B.2	1950mm(Type1)	1950 mm, type1
9	N. of pantographs: 1, 2, 3; Spacing: EN 50367:2006 Table B.4	Maximum number of raised pantographs: 5; Minimum spacing: TSI ENG, Table 4.2.13, column C	Maximum number not limited. Pantograph spacing : 200 m ( $v > 160$ km/h) 85 m ( $120 < v \leq 160$ km/h) 20 m ( $80 < v \leq 120$ km/h) 8 m ( $v \leq 80$ km/h)
10	Carbon with additive material	Plain carbon, Carbon with additive material	Plain Carbon
11	N	Y (according to EN 50367:2012 Figure A.3 Short Neutral section)	Y, <a href="#">RATO5</a> , Annex 25-27 : SSR 8.6330/7 SSR 8.6330/8 SSR 8.6330/9
12	N	Y (at borders on a bilateral basis; contact: <a href="mailto:banedanmark@bane.dk">banedanmark@bane.dk</a> )	N
13	N	Y	Y
14	170 N	120 N	$60 \text{ N} < F_m < 0.00047 \cdot v^2 + 90 \text{ N}$
15	N	N	Y



## ERA ERTMS UNIT

### ASSIGNMENT OF VALUES TO ETCS VARIABLES

	NID_CTRACTION = 28 Italy, conventional lines, 25 kV AC 50 Hz, 1950mm	NID_CTRACTION = 29 Israel, 25 kV AC 50 Hz
Parameter	list of requirements	list of requirements
1	AC 25kV-50Hz <i>acc. EN50163:2004</i>	AC 25kV-50 Hz max. frequency fluctuations 47-52.5 Hz, for 95% of the time 49-51 Hz
2	300 A	800 A
3	n.a.	N/A
4	Y	Y
5	5.50 m	5.50 m
6	5.80 m	6.40 m
7	4.625 m	5.02 m
8	1950 mm TSI LOC&PAS 4.2.8.2.9, EN50367:2013 A.2.2	1950 mm, Type 1 according to Figure B2 of EN 50367:2012 without insulated horns
9	15 m between two consecutive pantos	Spacing between pantographs: 20-35 m or larger than 85m
10	Plain carbon	Plain Carbon / Carbon with additive material
11	Y, short section according to EN 50367:2013 A.1.3	Y
12	Y, short section according to EN 50367:2013 A.1.3	N
13	N	Y
14	EN 50367:2013 table 6, target curve for AC systems, $v \leq 200$ km/h	Static nominal contact pressure force 70 N according to EN50367
15	Y	Y

## ERA ERTMS UNIT

### ASSIGNMENT OF VALUES TO ETCS VARIABLES

	NID_CTRACTION = 30 Norway 15kV AC 16.7Hz 450 A, 1800 mm	NID_CTRACTION = 31 Norway 15kV AC 16.7Hz 450 A, 1800/1950 mm	NID_CTRACTION = 32 Norway 15kV AC 16.7Hz 700 A, 1800 mm
Parameter	list of requirements	list of requirements	list of requirements
1	AC 15 kV 16.7 Hz	AC 15 kV 16.7 Hz	AC 15 kV 16.7 Hz
2	450 A	450 A	700 A
3	N/A	N/A	N/A
4	Y	Y	Y
5	5.60 m	5.60 m	5.60 m
6	6.20 m	6.20 m	6.20 m
7	4.80 m	4.80 m	4.80 m
8	1800 mm (NO,SE)	1800 mm (NO,SE) 1950 mm (Type 1)	1800 mm (NO,SE)
9	Maximum number of raised pantographs: 3 Minimum spacing: 20 m	Maximum number of raised pantographs: 3 Minimum spacing: 20 m	Maximum number of raised pantographs: 3 Minimum spacing: 20 m
10	TSI LOC & PAS 4.2.8.2.9.4.2	TSI LOC & PAS 4.2.8.2.9.4.2	TSI LOC & PAS 4.2.8.2.9.4.2
11	Y <a href="https://lovdata.no/dokument/SF/forskrift/2008-02-29-240/KAPITTEL_9-3#§9-35">https://lovdata.no/dokument/SF/forskrift/2008-02-29-240/KAPITTEL_9-3#§9-35</a>	Y <a href="https://lovdata.no/dokument/SF/forskrift/2008-02-29-240/KAPITTEL_9-3#§9-35">https://lovdata.no/dokument/SF/forskrift/2008-02-29-240/KAPITTEL_9-3#§9-35</a>	Y <a href="https://lovdata.no/dokument/SF/forskrift/2008-02-29-240/KAPITTEL_9-3#§9-35">https://lovdata.no/dokument/SF/forskrift/2008-02-29-240/KAPITTEL_9-3#§9-35</a>
12	N	N	N
13	Y	Y	Y
14	C curve: v ≤ 200 km/h: $F_{max} = 0.00047 \cdot v^2 + 90$ v > 200 km/h: $F_{max} = 0.00097 \cdot v^2 + 70$	C curve: v ≤ 200 km/h: $F_{max} = 0.00047 \cdot v^2 + 90$ v > 200 km/h: $F_{max} = 0.00097 \cdot v^2 + 70$	C curve: v ≤ 200 km/h: $F_{max} = 0,0047 \cdot v^2 + 90$ v > 200 km/h: $F_{max} = 0.00097 \cdot v^2 + 70$
15	Y	Y	Y

## ERA ERTMS UNIT

### ASSIGNMENT OF VALUES TO ETCS VARIABLES

	NID_CTRACTION = 33 Norway 15kV AC 16.7Hz 700 A, 1800/1950 mm	NID_CTRACTION = 34 Norway 15kV AC 16.7Hz 900 A, 1800 mm	NID_CTRACTION = 35 Norway 15kV AC 16.7Hz 900 A, 1800/1950 mm
Parameter	list of requirements	list of requirements	list of requirements
1	AC 15 kV 16.7 Hz	AC 15 kV 16.7 Hz	AC 15 kV 16.7 Hz
2	700 A	900 A	900 A
3	N/A	N/A	N/A
4	Y	Y	Y
5	5.60 m	5.60 m	5.60 m
6	6.20 m	6.20 m	6.20 m
7	4.80 m	4.80 m	4.80 m
8	1800 mm (NO,SE) 1950 mm (Type 1)	1800 mm (NO,SE)	1800 mm (NO,SE) 1950 mm (Type 1)
9	Maximum number of raised pantographs: 3 Minimum spacing: 20 m	Maximum number of raised pantographs: 3 Minimum spacing: 20 m	Maximum number of raised pantographs: 3 Minimum spacing: 20 m
10	TSI LOC & PAS 4.2.8.2.9.4.2	TSI LOC & PAS 4.2.8.2.9.4.2	TSI LOC & PAS 4.2.8.2.9.4.2
11	Y <a href="https://lovdata.no/dokument/SF/forskrift/2008-02-29-240/KAPITTEL_9-3#§9-35">https://lovdata.no/dokument/SF/forskrift/2008-02-29-240/KAPITTEL_9-3#§9-35</a>	Y <a href="https://lovdata.no/dokument/SF/forskrift/2008-02-29-240/KAPITTEL_9-3#§9-35">https://lovdata.no/dokument/SF/forskrift/2008-02-29-240/KAPITTEL_9-3#§9-35</a>	Y <a href="https://lovdata.no/dokument/SF/forskrift/2008-02-29-240/KAPITTEL_9-3#§9-35">https://lovdata.no/dokument/SF/forskrift/2008-02-29-240/KAPITTEL_9-3#§9-35</a>
12	N	N	N
13	Y	Y	Y
14	C curve: $v \leq 200 \text{ km/h:}$ $F_{\max} = 0.00047 \cdot v^2 + 90$ $v > 200 \text{ km/h:}$ $F_{\max} = 0.00097 \cdot v^2 + 70$	C curve: $v \leq 200 \text{ km/h:}$ $F_{\max} = 0.00047 \cdot v^2 + 90$ $v > 200 \text{ km/h:}$ $F_{\max} = 0.00097 \cdot v^2 + 70$	C curve: $v \leq 200 \text{ km/h:}$ $F_{\max} = 0,0047 \cdot v^2 + 90$ $v > 200 \text{ km/h:}$ $F_{\max} = 0.00097 \cdot v^2 + 70$
15	Y	Y	Y

## ERA ERTMS UNIT

### ASSIGNMENT OF VALUES TO ETCS VARIABLES

Parameter	list of requirements	list of requirements
	NID_CTRACTION = 36 Czech Republic, 25 kV AC 50 Hz	NID_CTRACTION = 37 Czech Republic, 3 kV DC
1	AC 25 V 50Hz	DC 3kV
2	800 A	3000 A
3	80 A	200 A
4	Y (according to trackside signalling)	Y (according to trackside signalling)
5	5.50 m	5.50 m
6	6.30 m	6.30 m
7	4.95 m	4.95 m
8	1950mm (type 1)	1950 mm (type 1)
9	2 pantographs spacing between them: type « A » (according to EN 50 367), 8 m ( $v \leq 80$ kph), 20 m ( $v \leq 120$ kph), 200 m (for maximum permitted speed)	2 pantographs, spacing between them: type « A » (according to EN 50 367), 8 m ( $v \leq 80$ kph), 20 m ( $v \leq 120$ kph), 200 m (for maximum permitted speed)
10	plain carbon	plain carbon carbon with additive material
11	Y (Short neutral section + Split neutral section configuration)	N
12	Y – Pantograph lowering necessary	Y – Pantograph lowering necessary
13	Y	Y
14	$F_{m \max} < 0.00047 * v^2 + 90$ [N]	$F_{m \max} < 0.00047 * v^2 + 110$ [N]
15	Y (new and modernised vehicles)	Y (new and modernised vehicles)

## ERA ERTMS UNIT

### ASSIGNMENT OF VALUES TO ETCS VARIABLES

	NID_CTRACTION = 38 Romania, conventional lines 120km/h, 25kV AC 50 Hz	NID_CTRACTION = 39 Romania, conventional lines 160km/h, 25kV AC 50 Hz	NID_CTRACTION = 40 Sweden, 15 kV AC 16.7 Hz, 900A
Parameter	list of requirements	list of requirements	list of requirements
1	AC 25kV 50 Hz	AC 25kV 50 Hz	AC 15kV-16.7Hz
2	600 A	640A	900A
3	N/A	N/A	N/A
4	N	N	Y
5	5.75 m	5.50 m	5.50 m
6	6.50 m	6.50 m	6.10 m
7	5.15 m	5.15 m	4.80 m
8	1800mm (old type – in operation) 1600mm (new type – in operation)	1950mm (old type – in operation) 1600mm (new type – in operation)	1950mm(Type1) 1800mm(NO,SE)
9	1 for neutral zone; the maximum distance between two active pantographs = 28m	2, distance between pantographs = 200m	Generally according to TSI Energy Tabell 4.2.13 column A, TSI LOC&Pas 4.2.8.2.9.7 and TSI Energy 4.2.15
10	Plain Carbon Metallised Carbon	Plain Carbon Metallised Carbon	TSI Loc&pas 4.2.8.2.9.4.2
11	Y, NZ made with a 40m length insulated section	Y, NZ made by 2 insulated overlaps, series marking	Y <a href="http://trvdokument.trafikverket.se/fileHandler.ashx?typ=showdokument&amp;id=4aef011e-be6b-40d0-b690-c55e3208c4f8">http://trvdokument.trafikverket.se/fileHandler.ashx?typ=showdokument&amp;id=4aef011e-be6b-40d0-b690-c55e3208c4f8</a>
12	N	N	Y There is only one system separation in Sweden. The system separation is on the border between  Danmark and Sweden and consist of 5 neutral zones and separates AC 25kV-50Hz from AC 15kV-16.7Hz

## ERA ERTMS UNIT

### ASSIGNMENT OF VALUES TO ETCS VARIABLES

	NID_CTRACTION = 38 Romania, conventional lines 120km/h, 25kV AC 50 Hz	NID_CTRACTION = 39 Romania, conventional lines 160km/h, 25kV AC 50 Hz	NID_CTRACTION = 40 Sweden, 15 kV AC 16.7 Hz, 900A
Parameter	list of requirements	list of requirements	list of requirements
13	Y	Y	<p>Y</p> <p>There is only one system separation in Sweden. The system separation is on the border between</p> <p>Danmark and Sweden and consist of 5 neutral zones and separates AC 25kV-50Hz from AC 15kV-16.7Hz</p>
14	Static 60-80N, maximum in operation 300N	Static 60-80N, maximum in operation 300N	<p>C curve:</p> <p><math>v \leq 200 \text{ km/h}</math>:</p> $F_{\max} = 0.00047 \cdot v^2 + 90$ <p><math>v &gt; 200 \text{ km/h}</math>:</p> $F_{\max} = 0.00097 \cdot v^2 + 70$ $F_{\min} = 0.00047 v^2 + 60$ <p>For existing lines see TSD LOC&amp;PASS 7.3.2.16</p>
15	N	<p>Y (maximum permitted speed for locomotive with ADD is 160km/h)</p> <p>N (maximum permitted speed for locomotive without ADD is 120km/h)</p>	Y

## ERA ERTMS UNIT

### ASSIGNMENT OF VALUES TO ETCS VARIABLES

	NID_CTRACTION = 44 Germany 1.2kV DC third rail	NID_CTRACTION = 45 Portugal 25 kV AC 50 Hz, 1450 mm (PT)	NID_CTRACTION = 46 Portugal 25 kV AC 50 Hz, EN50367 A6/1450 mm (PT)
Parameter	list of requirements	list of requirements	list of requirements
1	1.2kV DC third rail (side contact)	25 kV AC 50Hz	25 kV AC 50Hz
2	I= 5100 A IB 1 = 4000 A IB 2 = 2600 A	500A	500A
3	I= 3.2 A/m	N/A	N/A
4	Y	Y (if available)	Y (if available)
5	0.160 m	5.50 m	5.50 m
6	0.165 m	6.00 m	6.00 m
7	0.140 m	4.80 m	4.80 m
8	200 mm x 30 mm	1450 mm (PT)	EN50367 A6 1450 mm (PT)
9	35 m – 37 m; 4 per vehicle side; 100 km/h	No specific requirement	No specific requirement
10	copper E-Cu F 30	Plain Carbon	Plain Carbon
11	N/A	Y - L > 8.0m for consecutive pantographs - L ≤ 25.20m or L ≥ 39.68m for consecutive pantographs - L > 79.0m for non-consecutive pantographs (L = pantograph spacing EN - 50367)	Y - L > 8.0m for consecutive pantographs - L > 79.0m for non-consecutive pantographs (L = pantograph spacing EN - 50367)
12	Y	N	N
13	Y	N	Y – EN 50388
14	100 N+ 40 N per pantograph	Fm = 100 (V ≤ 140 km/h) Fm = 120 (140 < V ≤ 200 km/h)	Fm = 100 (V ≤ 140 km/h) Fm = 120 (140 < V ≤ 200 km/h)
15	N	N	N

## ERA ERTMS UNIT

### ASSIGNMENT OF VALUES TO ETCS VARIABLES

	NID_CTRACTION = 47 Luxemburg 25 kV AC 50 Hz	NID_CTRACTION = 48 Serbia 25 kV AC 50 Hz	NID_CTRACTION = 49 Egypt 25 kV AC 50 Hz High speed lines
Parameter	list of requirements	list of requirements	list of requirements
1	25kV AC 50Hz	25kV AC 50Hz	25kV AC 50Hz
2	500 A	640 A	700 A
3	N/A	N/A	N/A
4	Y	Y	Y
5	5.50 m	5.50 m	5.30 m
6	6.20 m	6.20 m	5.30 m @250 km/h
7	4.92 m	5.02 m	5.30 m
8	1600 mm (EP) 1450 mm 1600 mm (GB, CTRL)	1600 mm	1950 mm (Type 1)
9	4, for distance between them see RINF	2 pantographs Minimum spacing: 200 m	2 pantographs min. spacing: 180 m (160 km/h < v), 100 m (120 < v ≤ 160 km/h), 19 m (80 < v ≤ 120 km/h), 8 m (v ≤ 80 km/h)
10	Plain Carbon Impregnated carbon (35% of metallic content)	Plain Carbon	Plain carbon/carbon with additive material
11	Y, see RINF	Y short neutral section (<8m); split neutral section	Y, Acc. TSI 2014 section 4.2.15.2, a)
12	Y, see RINF	N	N
13	Y	Y	Y
14	$F_{m,min} (N) = 60 + 0.00047 v^2$ $F_{m,max} (N) = 90 + 0.00047 v^2$ [F <sub>m</sub> ] = Mean contact force in N [v] = Speed in km/h	$60 < F_m < 0.00047 v^2 + 90$ (N) v (km/h)	$F_m / N \leq 0.00097 v^2 + 70N$ $F_m / N \geq 0.00047 v^2 + 60N$ Or 130N
15	N	N	Y



## ERA ERTMS UNIT

### ASSIGNMENT OF VALUES TO ETCS VARIABLES

	NID_CTRACTION = 50 Slovak Republic 25kV AC 50Hz	NID_CTRACTION = 51 Slovak Republic 3kV DC 1200A	NID_CTRACTION = 52 Slovak Republic 3kV DC 1800A
Parameter	list of requirements	list of requirements	list of requirements
1	25kV AC 50Hz	3kV DC	3kV DC
2	300 A	1200 A	1800 A
3	80 A	200 A	200 A
4	Y (according to trackside signalling)	Y (according to trackside signalling)	Y (according to trackside signalling)
5	5.50 m	5.50 m	5.50 m
6	6.20 m	6.20 m	6.20 m
7	5.00 m	4.95 m	4.95 m
8	1 950 mm (type 1)	1 950 mm (type 1)	1 950 mm (type 1)
9	2 pantographs, spacing between them min. 8 m	2 pantographs, spacing between them min. 8 m	2 pantographs, spacing between them min. 8 m
10	plain carbon	plain carbon carbon with additive material	plain carbon carbon with additive material
11	Y	N	N
12	Y	Y	Y
13	Y	Y	Y
14	$F_{m \max.} < 0.00047 * v^2 + 90$ [N]	$F_{m \max.} < 0.00097 * v^2 + 110$ [N]	$F_{m \max.} < 0.00097 * v^2 + 110$ [N]
15	Y (new and modernised vehicles)	Y (new and modernised vehicles)	Y (new and modernised vehicles)

## ERA ERTMS UNIT

### ASSIGNMENT OF VALUES TO ETCS VARIABLES

	NID_CTRACTION = 53 Slovak Republic 3 kV DC 2000 A	NID_CTRACTION = 54 Slovak Republic 3 kV DC 2200 A	NID_CTRACTION = 55 Slovak Republic 3 kV DC 2400 A
Parameter	list of requirements	list of requirements	list of requirements
1	3 kV DC	3 kV DC	3 kV DC
2	2000 A	2200 A	2400 A
3	200 A	200 A	200 A
4	Y (according to trackside signalling)	Y (according to trackside signalling)	Y (according to trackside signalling)
5	5.50 m	5.50 m	5.50 m
6	6.20 m	6.20 m	6.20 m
7	4.95 m	4.95 m	4.95 m
8	1 950 mm (type 1)	1 950 mm (type 1)	1 950 mm (type 1)
9	2 pantographs, spacing between them min. 8 m	2 pantographs, spacing between them min. 8 m	2 pantographs, spacing between them min. 8 m
10	plain carbon carbon with additive material	plain carbon carbon with additive material	plain carbon carbon with additive material
11	N	N	N
12	Y	Y	Y
13	Y	Y	Y
14	$F_{m \max.} < 0.00097 * v^2 + 110$ [N]	$F_{m \max.} < 0.00097 * v^2 + 110$ [N]	$F_{m \max.} < 0.00097 * v^2 + 110$ [N]
15	Y (new and modernised vehicles)	Y (new and modernised vehicles)	Y (new and modernised vehicles)

## ERA ERTMS UNIT

### ASSIGNMENT OF VALUES TO ETCS VARIABLES

	NID_CTRACTION = 56 Slovak Republic 3 kV DC 2800 A	NID_CTRACTION = 57 Slovak Republic 3 kV DC 3000 A	NID_CTRACTION = 58 Slovak Republic 3 kV DC 3200 A
Parameter	list of requirements	list of requirements	list of requirements
1	3 kV DC	3 kV DC	3 kV DC
2	2800 A	3000 A	3200 A
3	200 A	200 A	200 A
4	Y (according to trackside signalling)	Y (according to trackside signalling)	Y (according to trackside signalling)
5	5.50 m	5.50 m	5.50 m
6	6.20 m	6.20 m	6.20 m
7	4.95 m	4.95 m	4.95 m
8	1 950 mm (type 1)	1 950 mm (type 1)	1 950 mm (type 1)
9	2 pantographs, spacing between them min. 8 m	2 pantographs, spacing between them min. 8 m	2 pantographs, spacing between them min. 8 m
10	plain carbon carbon with additive material	plain carbon carbon with additive material	plain carbon carbon with additive material
11	N	N	N
12	Y	Y	Y
13	Y	Y	Y
14	$F_{m \max.} < 0.00097 * v^2 + 110$ [N]	$F_{m \max.} < 0.00097 * v^2 + 110$ [N]	$F_{m \max.} < 0.00097 * v^2 + 110$ [N]
15	Y (new and modernised vehicles)	Y (new and modernised vehicles)	Y (new and modernised vehicles)

## ERA ERTMS UNIT

### ASSIGNMENT OF VALUES TO ETCS VARIABLES

Parameter	list of requirements	list of requirements
	NID_CTRACTION = 59 Ireland DART 1.5 kV DC	NID_CTRACTION = 60 Spain 1.5kV DC conventional lines 90 km/h max. line speed
1	1.5 kV DC	1.5 kV DC
2	2000 A for 4 seconds, 1000 A	1800 A
3	300 A	200 A
4	Y	Y
5	4.70 m	4.70 m
6	5.70 m	5.00 m
7	4.19 m	4.30 m
8	1800 mm (according to TSI LOC&PAS 4.2.8.2.9.3)	1700 mm
9	Maximum raised pantographs: 4  Minimum spacing: 42 m	Maximum number of raised pantographs: 2  Minimum spacing: 12 m
10	Carbon with additive	Carbon with cladde copper
11	N	N
12	N	N
13	Y	N
14	Static: 85N  Maximum in operation: 130N	80 ± 10 N
15	Yes (for trains with maximum permitted speed over 110 km/h)  No (for trains with maximum permitted speed of 110 km/h)	Y

## ERA ERTMS UNIT

### ASSIGNMENT OF VALUES TO ETCS VARIABLES

	NID_CTRACTION = 61 Poland, 25 kV AC 50 Hz	NID_CTRACTION = 62 Poland, 3 kV DC
Parameter	list of requirements	list of requirements
1	25 kV AC 50 Hz	3 kV DC
2	800 A	3200 A
3	N/A	200 A
4	Y	Y
5	5.20 m	5.20 m
6	5.30 m	5.60 m
7	5.08 m	5.00 m
8	1600 mm, compliant with EN 50367  1950mm, compliant with EN 50367	1950mm, compliant with EN 50367
9	According to EN 50367, type of catenary construction A:  v ≥ 250 km/h : 200 m 160 km/h < v < 250 km/h : 200 m 120 km/h < v ≤ 160 km/h : 85 m 80 km/h < v ≤ 120 km/h : 20 m v ≤ 80 km/h : 8 m  (v – design speed)	According to EN 50367, type of catenary construction A:  v ≥ 250 km/h : 200 m 160 km/h < v < 250 km/h : 200 m 120 km/h < v ≤ 160 km/h : 20 m 80 km/h < v ≤ 120 km/h : 20 m v ≤ 80 km/h : 8 m  (v – design speed)
10	plain carbon carbon with additive material	plain carbon carbon with additive material
11	Y  (Line under design, separation section will comply with EN 50367.  Details will be published in RINF and on the infrastructure manager's internet site when the line is built.)	N
12	Y  (Line under design, separation section will comply with EN 50367.  Details will be published in RINF and on the IM's website when the line is built.)	Y  (Line under design, separation section will comply with EN 50367.  Details will be published in RINF and on the IM's website when the line is built.)
13	Y (according to EN 50388)	Y (according to EN 50388)
14	According to EN 50367, Table 6	According to EN 50367, Table 6
15	Y	Y

## ERA ERTMS UNIT

### ASSIGNMENT OF VALUES TO ETCS VARIABLES

Parameter	list of requirements	list of requirements																		
	NID_CTRACTION = 63 Philippines 1.5 kV DC NSCR-N1 line	NID_CTRACTION = 64 Philippines 1.5 kV DC NSCR-Extension line																		
1	1.5 kV DC	1.5 kV DC																		
2	1600 A	6162 A																		
3	400 A	795 A																		
4	Y	Y																		
5	4.80 m	4.80 m																		
6	5.00 m	5.40 m (margin 0.015m)																		
7	4.40 m	4.40 m																		
8	1880 mm (JIS E 6302, Category 2)	1880 mm																		
9	Maximum 2 raised pantographs with a minimum 20 m spacing	<p><u>NS-02 :</u></p> <table border="1" style="width: 100%; border-collapse: collapse;"> <thead> <tr style="background-color: #C00000; color: white;"> <th>Train</th> <th>Configuration</th> <th>Inter-Distances</th> </tr> </thead> <tbody> <tr> <td>8-car Train</td> <td>Four-pantograph configuration</td> <td>20 m - 60 m - 20 m</td> </tr> <tr> <td>10-car Train</td> <td>Five-pantograph configuration</td> <td>20 m - 20m - 60 m - 40 m 40 m - 60m - 20 m - 20 m</td> </tr> </tbody> </table> <p><u>NS-03 :</u></p> <table border="1" style="width: 100%; border-collapse: collapse;"> <thead> <tr style="background-color: #C00000; color: white;"> <th>Train</th> <th>Configuration</th> <th>Inter-Distances</th> </tr> </thead> <tbody> <tr> <td>8-car Train</td> <td><del>Two</del>-pantograph configuration</td> <td>73.8 m / 93.8 m</td> </tr> <tr> <td>10-car Train</td> <td><del>Three</del>-pantograph configuration</td> <td>40 m – 73.8 m 73.8 m – 40 m</td> </tr> </tbody> </table>	Train	Configuration	Inter-Distances	8-car Train	Four-pantograph configuration	20 m - 60 m - 20 m	10-car Train	Five-pantograph configuration	20 m - 20m - 60 m - 40 m 40 m - 60m - 20 m - 20 m	Train	Configuration	Inter-Distances	8-car Train	<del>Two</del> -pantograph configuration	73.8 m / 93.8 m	10-car Train	<del>Three</del> -pantograph configuration	40 m – 73.8 m 73.8 m – 40 m
Train	Configuration	Inter-Distances																		
8-car Train	Four-pantograph configuration	20 m - 60 m - 20 m																		
10-car Train	Five-pantograph configuration	20 m - 20m - 60 m - 40 m 40 m - 60m - 20 m - 20 m																		
Train	Configuration	Inter-Distances																		
8-car Train	<del>Two</del> -pantograph configuration	73.8 m / 93.8 m																		
10-car Train	<del>Three</del> -pantograph configuration	40 m – 73.8 m 73.8 m – 40 m																		
10	Sintered Alloy/Aluminium Alloy/Carbon	Sintered alloy/Aluminum alloy/Copper infused carbon																		
11	N	Y, Insulated overlap at OCL separation with Bi-Pole isolator switch & IRJ (Insulated rail joint at track)																		
12	N	Y, Insulated overlap at OCL separation with Bi-Pole isolator switch & IRJ (Insulated rail joint at track)																		
13	Y	Y																		
14	EN 50367, Table 6, target curve for DC 1.5 kV systems, $v \leq 200$ km/h or JIS E 6302, Category 2, target range for systems up to DC 1.5 kV, $v \leq 130$ km/h	NS-02: $59 \pm 2$ N (at nominal working height) NS-03: The nominal contact force is between 70 and 140 N																		
15	N	N																		