

ERTMS/ATO

System Requirements Specification

REF : SUBSET-125

ISSUE : 1.1.0

DATE : 06-12-2024

1. MODIFICATION HISTORY

Issue Number Date	Section Number	Modification / Description	Author
0.0.1 07-10-2013	All	New document	UNISIG ATO WP
0.0.2 08-01-2014	All	The document structure and content has been changed according to the following minutes of ATO workshops: <ul style="list-style-type: none"> - Ten-T- AoE – Minutes of Meeting – 16 10 13 – v 1 1.docx - Ten-T – Minutes of Meeting – 6 11 13 – V 1 2.docx - Ten-T – AoE – Minutes of Meeting – 27 11 13.docx - Ten-T – Minutes of Meeting – 11 12 13 – V 1.1.docx 	UNISIG ATO WP
0.0.3 22-01-2014	All	The document structure and content has been changed according to the following minutes of ATO workshop: <ul style="list-style-type: none"> - Ten-T – Minutes of Meeting – 15 01 2014 – V 1.0.docx 	UNISIG ATO WP
0.0.4 27-01-2014	All	The document content has been changed according to the comments referring the last version (0.0.3)	UNISIG ATO WP
0.0.5 28-01-2014	6.1.6, 7.2.1, 7.2.2, 10, 12.5	The document content has been changed according to the comments referring the last version (0.0.4) and the issues discussed during the call conference of 28-01-2014.	UNISIG ATO WP
0.0.6 20-06-2014	All	The document content has been changed according to the UNISIG ATO WP comments and discussions referring to the ATO-OB – ATO-TS interface (SUBSET-126), the EUG comments referring the last version (0.0.5) and the issues discussed during the UNISIG WS.	UNISIG ATO WP
0.0.7 29-08-2014	All	The document content has been updated according to the UNISIG ATO WP and SC comments referring to version (0.0.6) and UNISIG ATO WP WSs of June, July and August.	UNISIG ATO WP

ERA * UNISIG * EEIG ERTMS USERS GROUP

Issue Number Date	Section Number	Modification / Description	Author
0.0.8 01-09-2014	6.1.1, 6.3.2, 7.7, 7.8, 7.9, 8.1, 10.2, 10.3, 11.1.2, 12.1.3, 12.4.2	The document content has been updated according to the UNISIG ATO WP call conference of 01/09/2014 about the issues still open after 0.0.6 review.	UNISIG ATO WP
0.0.9 03-09-2014	6.3.3.9, 7.8.1.1, 8.2.1.3, 8.6.1.1, 8.8.1.1, 9.4.1.1, 9.4.1.8, 11.2.5.1, 12.4.2.11, 12.4.2.16	The document content has been updated according to the UNISIG ATO WP review of version 0.0.7.	UNISIG ATO WP
0.0.10 20-04-2015	All	The document content has been updated according to the EUG, ERA, UNISIG SG and UNISIG ATO WP comments on version 0.0.9. The chapters 7, 8 and 12 have been reorganised after SUBSET-130 and SUBSET-131 discussions. The Appendix ATO-OB/ATO-TS Communication Sequences has been moved from SUBSET 126.	UNISIG ATO WP
0.0.11 07-01-2016	6.1.1.18, 7.5.1.2, 8.7.1.1, 11.1.2.1, 11.5.2.5, 11.5.4.1, 12.1.1.8	Minor changes according to UNISIG ATO WP Workshops of May, June and July 2015.	UNISIG ATO WP
0.0.12 11-04-2016	All	Modification according to ATO WP review.	UNISIG ATO WP
0.0.13 19-07-2016	6.3, 7.2.1, 7.8, 7.9, 7.10, 8.6.3, 8.4, 9.1.3, 9.8	Modification according to ATO WP review.	UNISIG ATO WP
0.0.14 25-08-2016	5.3, 7.2.1.2, 7.2.2.4, 7.10.1.2, 7.10.3.2, 8.3.6.3, 8.3.6.8, 9.8.1.1, 9.7.9	Modification according to ATO WP review.	UNISIG ATO WP
0.0.15 27-04-2017	All	Modification according to UNISIG SG, EUG and ATO WP review.	UNISIG ATO WP
0.0.16 19-05-2017	All	Modification according to ATO WP review.	UNISIG ATO WP
0.0.17 draft A 21-11-2017	All	Modification according to ERA and UNISIG SG review.	UNISIG ATO WP

ERA * UNISIG * EEIG ERTMS USERS GROUP

Issue Number Date	Section Number	Modification / Description	Author
0.0.17 draft B 24-11-2017	9.6, 9.13.10 conditions [2], [9b] and [9c]	Specification of ATO CO State, modification of condition [2] and switch text for conditions [9b] and [9c].	UNISIG ATO WP
0.0.17 draft C 15-12-2017	6.3.1.3, 6.3.1.8, 6.4.2.1, 7.2.2, 7.4, 7.13, 7.14, 8, 9.1.1, 9.2, 9.10, 9.11, 9.12, 12	Modification according to remaining comments of ERA and UNISIG SG review on version 0016 and DMI summary paper.	UNISIG ATO WP
0.0.17 22-12-2017	6.4.2.1, 7.2.1.1, 7.2.2.4, 7.2.3, 8.2.6, 8.2.7, 8.2.8, 8.2.2, 8.2.3, 10.1.1.13, 10.1.1.14, 10.1.1.22, 10.1.1.23	Modification according to ATO WP review.	UNISIG ATO WP
0.0.18 09-03-2018	5.2, 6.3, 6.3.2, 6.4.2, 6.4.3, 7.1, 7.2, 7.9.2, 7.3, 7.11, 7.14, 8.1, 8.2, 9.1.1, 9.3, 9.8, 9.10, 9.11, 9.12 10.1, 10.2, 12.3	Modification according to EECT actions 34.01, 36.02, 37.09, ERA and UNISIG SG comments on version 0017 and specification of the requirements related to the ATO-OB/ETCS-OB interface.	UNISIG ATO WP
0.0.19 09-04-2018	7.1.2, 7.2.1, 7.2.2, 7.4, 7.7, 7.8, 7.10.3, 7.11, 7.14, 8.1, 8.2, 9.1.1, 9.10.3, 9.10.7, 9.10.8, 9.10.9, 10.1, 10.2	Modification according to EECT actions 39.02, 39.03, 39.04 and ERA and UNISIG SG comments on version 0018.	UNISIG ATO WP
0.1.0 04-05-2018	5.2, 5.3, 5.4, 6.2, 6.4.3, 7.1.2, 7.1.5, 7.2.1, 7.11, 7.14.1, 8.2, 9.12, 10.2.3, 10.2.5, 10.2.7, 10.2.9	Modification according to EECT actions 40.01, 40.02 and 40.03; ERA and UNISIG SG remaining comments on version 0018 and new structure for chapter 7.11.	UNISIG ATO WP
0.1.1 05-11-2019		Modification according to EECT # 57 review	UNISIG ATO WP EECT
0.1.2 03-12-2019		Modification according to EECT #58 review	UNISIG ATO WP EECT
0.1.3 09-01-2020		Modification according to EECT #59 review	UNISIG ATO WP EECT

ERA * UNISIG * EEIG ERTMS USERS GROUP

Issue Number Date	Section Number	Modification / Description	Author
0.1.4 04-02-2020		Modification according to EECT #60 review	UNISIG ATO-WP EECT
0.1.5 16-06-2021	1, 6.3.1.2, 7.6.1.2, 7.8.1.6, 7.6.1.4, 8.2.3.2.1, 10.2.2.4, 10.2.2.5, 10.2.2.6, 10.2.2.8	Modification according to EECT #59 review Modification according to EECT #67 review Modification according to EECT #68 review Modification according to EECT #70 review	UNISIG ATO-WP
0.1.6 15-07-2021	10.1, 10.2	Modification Chapter 10.1 according to the ATO Communication Session principles. Modification of Chapter 10.2 according to EECT discussions held on Subset 130.	UNISIG ATO-WP
0.1.7 20-07-2021	10.3, 10.4	Creation of chapter 10.3 according to Subset 139, ATO-OB / TCMS interface. Creation of chapter 10.4 according to Subset 140, ATO-OB / ORD interface.	UNISIG ATO-WP
0.1.8 05-08-21	10.1, 10.2, 10.4	Modification according to ATO-WP review.	UNISIG ATO-WP
0.1.9 31-08-21	5.2, figure 1, 6.3.4, 7.2.3.1, 7.3, 7.6.1.4.1, 7.7.1.3, 7.8.1.9, 8.2.3.1, 9.11, 10.1, 10.2.5.1, 10.2.7.1, 10.3, 10.4	Modification according to EECT #77 review.	UNISIG ATO-WP

ERA * UNISIG * EEIG ERTMS USERS GROUP

Issue Number Date	Section Number	Modification / Description	Author
0.1.10	5.1.1.9, 6.2.1.6, 6.2.1.7, 6.2.1.8, 6.2.1.10, 6.3.4, 6.3.4.1, 6.4.2.1, 6.4.2.2, 6.4.2.6, 6.4.2.7, 6.4.2.11, 6.4.3.2, 6.4.3.3, 6.4.3.8, 6.4.3.9, 6.4.3.10, 6.4.3.11, 7.1.2.2, 7.1.2.8, 7.1.3.9, 7.1.5.2, 7.1.5.3, 7.1.5.4, 7.2.2.2, 7.2.2.3, 7.2.1.4, 7.4.1.2, 7.5.1.3, 7.7.1.6, 7.8.3.1, 7.13.1.4, 8.2.1.5, 9.1.1.2, 9.1.2.1, 9.9.1.4, 10.1.7.2, 10.1.7.4.1, 10.1.7.10, 10.1.7.17, 10.2.2.8, 10.2.2.10, Figure 1, Figure 4, Figure 10, Table 5, Table 6	Modification according to CRs listed in batch 5 for supporting the EECT discussions.	UNISIG ATO-WP
0.1.11 20-10-2021	6.3.1, 6.3.1.4, 6.3.1.5, 6.3.1.6, 7.5.1.4, 7.10.1.3, 7.13.1.7, 10.1.7.22, 10.2.3.8, 10.2.4.3, 10.2.4.4, Table 10	Modification according to EECT #78 review (batch 5).	UNISIG ATO-WP
0.1.12 24-01-2022	6.4.3, 7.1.2.2, 7.1.5, 7.3.1.7, 9.1.2.1, 9.6.1.3, 9.10, 9.12.1.1, 10.1.3.14, 10.1.4, 10.1.6, 10.1.7, 10.1.8, 10.2.7.1, 10.2.3.3, 10.2.3.6, 10.2.7.13, 10.3.7, 12	Modification according to CRs listed in batch 6 for supporting the EECT discussions. Modified according to updated CRs listed in batch 6, sent 2021-11-19. Modified according to the answers to the open actions 77.06, 78.11, 78.12, 78.13, 78.14, 78.15, 78.17	UNISIG ATO-WP
	5.2, 6.1, 6.2.1.15, 6.4.2.9, 6.4.3.2 l), 7.1.2.2 h), 7.1.5.2 b),	Batch 5 modifications updated according to EECT comments.	UNISIG ATO-WP

ERA * UNISIG * EEIG ERTMS USERS GROUP

Issue Number Date	Section Number	Modification / Description	Author
		Modification according to EECT #81 review 07/12/21 and 13/01/22 (batch 5 and batch 6). Typos according to ATO-WP meeting 2022-01-18.	UNISIG ATO-WP
0.1.13 09-02-2022	6.3.1, 6.4.3, 7.1.5, 9.10, 9.11, 10.2.2, 10.2.9	Modified according to the answers to the open actions 78.14, 78.17, 80.07, 80.09, 80.10.	UNISIG ATO-WP
0.1.14 18-02-2022	All	Modifications according to EECT #82 review	EECT
0.2.0 24-03-2022	All	Modifications according to EECT #83 review	EECT
0.2.1 21-02-2023	All	Modifications in relation to CRs 1344 & 1370 Outcome of B4R1 2 nd consolidation phase	EECT
0.2.2 22-05-23	All	Outcome of B4R1 3 rd consolidation phase	EECT
0.2.3 22-06-23	5.1.1.5, 5.1.1.11	CR1342 update	ERA
1.0.0 05-07-23	-	Version for ERTMS/ATO Baseline 1 1 st release and ERTMS/ETCS Baseline 4 1 st release	ERA
1.0.1 21-08-24	7.9.4, 10.2.9, 10.3.1	Introduction of ATO system version 1.1 (see CR 1457)	ERA
1.0.2 18-09-24	7.9.4, 7.9.5	Modifications according to EECT #110 review	ERA
1.0.3 02-12-24	5.2, 7.9.4, 7.9.5	Modifications according to EECT #111 review	ERA
1.1.0 06-12-24	-	New version for ERTMS/ATO Baseline 1 1 st release and ERTMS/ETCS Baseline 4 1 st release	ERA

2. TABLE OF CONTENTS

1. Modification History	2
2. Table of Contents	8
3. Table of Figures.....	12
4. List of Tables	13
5. Introduction.....	14
5.1 Scope and purpose of the document.....	14
5.2 Reference documents	16
5.3 Abbreviations	18
5.4 Definitions	18
6. Overview	19
6.1 ERTMS/ATO Reference Architecture.....	19
6.2 Generic Requirements	19
6.3 Exported constraints	20
6.3.1 Train	20
6.3.2 Infrastructure Manager.....	21
6.3.3 Train doors management.....	21
6.3.4 Control Centre	21
6.4 Journey Profiles and Segment Profiles.....	22
6.4.1 Introduction.....	22
6.4.2 Journey Profile (JP)	22
6.4.3 Segment Profile (SP)	24
7. ATO Functions.....	26
7.1 Driving Function	26
7.1.1 Introduction.....	26
7.1.2 Time Table Speed Management (TTSM).....	27
7.1.3 Supervised Speed Envelope Management (SSEM).....	28
7.1.4 Automatic Train Stopping Management (ATSM).....	29
7.1.5 ATO Traction / Brake Control.....	30
7.2 Timing Point Management	33
7.2.1 Timing Point states	33
7.2.2 Train Door Operation (TDO)	34
7.2.3 Dwell time Management	37
7.3 Add/skip Stopping Point	37

ERA * UNISIG * EEIG ERTMS USERS GROUP

7.4	Train Hold at a Stopping Point	38
7.5	Low Adhesion Management.....	38
7.6	Time Management	39
7.7	Reporting Management.....	39
7.8	Data Consistency Management	41
7.8.1	Introduction.....	41
7.8.2	Routing Errors	41
7.8.3	Segment and Journey Profiles Consistency Error	41
7.9	ATO System Version Management.....	43
7.9.1	Introduction.....	43
7.9.2	Compatibility/Incompatibility criteria	43
7.9.3	Use of the ATO system version	44
7.9.4	Envelopes of system versions.....	44
7.9.5	ATO-OB system version vs. ETCS-OB system version.....	45
7.10	ATO-OB Train Position Determination	45
7.11	Driving Advisory System (DAS)	48
7.12	Perform ATO-OB self-tests.....	48
7.13	ATO-OB Data acquisition	49
7.13.1	ETCS Data	49
7.13.2	Specific ATO Data Entry	50
7.13.3	Specific ATO Data View.....	54
7.13.4	Limitations related to Specific ATO Data Entry/Data View	56
8.	Driver Machine Interface.....	57
8.1	Available Inputs from the driver	57
8.2	Information to be displayed to the driver.....	57
8.2.1	ATO Status.....	57
8.2.2	Stopping accuracy	58
8.2.3	Dwell time	58
8.2.4	Door information	59
8.2.5	Skip Stopping Point status	59
8.2.6	Stopping Points distance	60
8.2.7	Stopping Point name and estimated arrival time	60
8.2.8	DAS information.....	60
8.2.9	Driver warning sounds	61
8.2.10	ATO DMI inputs versus State Table.....	62

ERA * UNISIG * EEIG ERTMS USERS GROUP

8.2.11	ATO DMI outputs versus State Table.....	62
9.	ATO Operation States	63
9.1	Main concepts.....	63
9.1.1	ATO Operational Conditions	63
9.1.2	ATO Engagement Conditions	63
9.2	No Power (NP).....	64
9.3	ATO Configuration (CO).....	64
9.4	ATO Not Available (NA)	64
9.5	ATO Available (AV).....	64
9.6	ATO Ready (RE).....	64
9.7	ATO Engaged (EG).....	65
9.8	ATO Disengaging (DE)	65
9.9	ATO Failure (FA).....	65
9.10	Transitions between States	66
9.10.1	Introduction.....	66
9.10.2	Nominal scenario.....	66
9.10.3	Alternative scenario: Losing ATO Operational Conditions.....	67
9.10.4	Alternative scenario: ATO Failure	68
9.10.5	Alternative scenario: Driver brakes manually while the train is automatically driven..	68
9.10.6	Flowchart of ATO-OB State transitions	68
9.10.7	Symbols.....	70
9.10.8	Transition table	70
9.10.9	Transition conditions table	71
9.11	ATO-OB Active Functions Table.....	72
9.12	ETCS Mode transition request.....	73
10.	Interfaces.....	74
10.1	ATO-OB / ATO-TS interface	74
10.1.1	Introduction.....	74
10.1.2	Conditions for establishing a communication session	74
10.1.3	Establishing communication sessions.....	75
10.1.4	Hand-over between two adjacent ATO-TS.....	76
10.1.5	Maintaining communication sessions.....	77
10.1.6	Communication session termination	78
10.1.7	Packet exchange requirements.....	78
10.1.8	Communication Session Transitions.....	83

ERA * UNISIG * EEIG ERTMS USERS GROUP

10.2	ATO-OB / ETCS-OB interface	86
10.2.1	Introduction.....	86
10.2.2	Communication management	86
10.2.3	General requirements	87
10.2.4	ETCS Data	88
10.2.5	Position data.....	88
10.2.6	Balise information	89
10.2.7	Supervision information	90
10.2.8	Driver inputs	94
10.2.9	Configuration Management.....	94
10.3	ATO-OB / Rolling Stock Interface	95
10.3.1	Configuration management.....	95
11.	Configurability.....	96
11.1	Description	96

3. TABLE OF FIGURES

Figure 1 ERTMS/ATO reference architecture	19
Figure 2 ATO driving function.....	26
Figure 3 Door operation diagrams	36
Figure 4 Train position within the SP	46
Figure 5 Train position to supervise ETCS-OB elements.....	47
Figure 6 Specific ATO Data Entry performed	53
Figure 7 Specific ATO Data Entry skipped	54
Figure 8 Specific ATO Data Entry aborted.....	54
Figure 9 Nominal scenario	67
Figure 10 State Transitions	69
Figure 11 Communication sequence	81
Figure 12 Communication Session State Transitions	84
Figure 13 Example for sending safe emergency brake deceleration values	92

4. LIST OF TABLES

Table 1 Grades of Automation high level description.....	14
Table 2 Reference Documents.....	17
Table 3 Train brake release time.....	32
Table 3a ATO-OB/ETCS-OB possible system version number combinations.....	45
Table 4 ATO DMI inputs versus State Table	62
Table 5 ATO DMI outputs versus State table	62
Table 6 Transition table.....	70
Table 7 Transition conditions table	71
Table 8 ATO-OB Active Functions table	73
Table 9 Transition table.....	84
Table 10 Transition conditions table	86
Table 11 Configuration Items	94
Table 12 Configuration Items	95

5. INTRODUCTION

5.1 Scope and purpose of the document

- 5.1.1.1 The European Railways are currently in the process of implementing ERTMS. A further step in achieving improved capacity, on-time performance and opportunities to realise energy efficiency improvements is to develop and implement Automatic Train Operation (ATO).
- 5.1.1.2 ERTMS/ATO provides a set of non-safety functions related to speed control, accurate stopping, door opening and closing, and other functions traditionally assigned to a driver, while the safety of operation is still ensured by ETCS with regards to the speed and distance limits and also by other safe systems.
- 5.1.1.3 ERTMS/ATO covers a wide range of applications from manually assisted to fully automated train operation. Possible actual operation depends on the desired grade of automation (GoA) and the automation level supported by IM on a specific route.
- 5.1.1.4 The definition of GoA arises from apportioning responsibility for the given functions of railway operations between operational staff and involved technical railway systems. The table below defines the operation principles for each GoA level.

GoA	GoA Name	Train Operator	Description
GoA1	Non automated train operation	Train driver in the cab	The train is driven manually; but protected by automatic train protection (ATP). This GoA can also include providing advisory information to assist manual driving.
GoA2	Semi-automated train operation	Train driver in the cab	The train is driven automatically, stopping is automated but a driver in the cab is required to start automatic driving of the train, the driver can operate the doors (although this can also be done automatically), the driver is still in the cab to check the track ahead is clear and carry out other manual functions. The driver can take over in emergency or degraded situations.
GoA3	Driverless train operation	Train attendant on-board the train	The train is operated automatically including automatic departure, a train attendant has some operational tasks, e.g. operating the train doors (although this can also be done automatically) and can assume control in case of emergency or degraded situations.
GoA4	Unattended train operation	No staff on-board competent to operate the train	Unattended train operation; all functions of train operation are automatic with no staff on-board to assume control in case of emergencies or degraded situations.

Table 1 Grades of Automation high level description

- 5.1.1.5 While mainline railway applications usually apply non-automated train operation, e.g., GoA1 presently for ETCS Level 1 and ETCS Level 2, Urban Transport Systems are demonstrating across the world the capability of Automated Train Operation to increase line capacity and to reduce energy consumption, compared to manual train operation.

- 5.1.1.6 With the introduction of ERTMS/ATO, Automated Train Operation (GoA2 to GoA4) will be beneficial for the different kinds of railway operation:
- a) For High Speed Lines, Intercity lines and Regional lines, ERTMS/ATO will enhance the timetable adherence, provide high performance and enable the introduction of train traction energy saving functions fully managed by the ATO.
 - b) For Freight lines, ERTMS/ATO is supporting a smoother operation (e.g., allowing efficient conflict management and minimising unexpected train stops, support loading/unloading operations...) which lead to energy savings, but also to improved line capacity.
 - c) For Urban and Suburban applications, ERTMS/ATO will permit to provide high performance for lines carrying intensive inner suburban and cross-city traffic. ATO will also bring energy saving for these types of operation.
- 5.1.1.7 The ATO Operational Concept was defined by the EEIG ERTMS Users Group up to GoA4:
- a) ERTMS/ATO Operational Principles [Ref 1];
 - b) ERTMS/ATO Operational Requirements [Ref 2];
 - c) ERTMS/ATO Glossary [Ref 3];
 - d) ERTMS/ATO Operational Scenarios [Ref 4].
- 5.1.1.8 As ERTMS/ATO equipped trains shall be able to operate over any ERTMS/ATO equipped track, the interface between ERTMS/ATO on-board and trackside must be technically interoperable, i.e. messages, commands, data etc. communicated between them must be understood by the receiver as intended by the sender.
- 5.1.1.9 The following interfaces are specified:
- a) ATO-OB / ATO-TS Interface [Ref 7] & [Ref 8];
 - b) ETCS-OB / ATO-OB Interface [Ref 6] & [Ref 10];
 - c) ATO-OB / Rolling Stock Interface [Ref 9] & [Ref 14];
- 5.1.1.10 The **scope** of this document is to define the system functional requirements for an interoperable ERTMS/ATO system, limited to GoA2 (excluding GoA3 and GoA4).
- 5.1.1.11 This specification is applicable for ETCS levels 1 and 2.
- 5.1.1.12 The following topics are out of scope of this document:
- a) ATO operation with no ETCS-OB;
 - b) GoA3 and GoA4.

ERA * UNISIG * EEIG ERTMS USERS GROUP

5.1.1.13 The **purpose** of this document is to specify the system requirements that must be fulfilled in order to provide an interoperable solution for ERTMS/ATO (GoA2). It defines the following:

- a) ATO related functions (including DAS);
- b) Driver Machine Interface principles;
- c) ATO Operational States;
- d) ERTMS/ATO architecture (including the definition of all interfaces and the level of standardisation).

5.2 Reference documents

Ref. N°	Title	Reference
[Ref 1]	ERTMS/ATO Operational Principles	12E108
[Ref 2]	ERTMS/ATO Operational Requirements	13E137
[Ref 3]	ERTMS/ATO Glossary	13E154
[Ref 4]	ERTMS/ATO Operational Scenarios	13E151
[Ref 5]	ERTMS/ETCS System Requirements Specification	SUBSET-026
[Ref 6]	ETCS-OB / ATO-OB FFFIS Application Layer	SUBSET-130
[Ref 7]	ATO-OB / ATO-TS FFFIS Application Layer	SUBSET-126
[Ref 8]	ATO-OB / ATO-TS FFFIS Transport and Security Layers	SUBSET-148
[Ref 9]	ATO-OB / Rolling Stock FFFIS Application Layer	SUBSET-139
[Ref 10]	ATO-OB Interface Specification Communication Layers for On-board Communication	SUBSET-143
[Ref 11]	ETCS Driver Machine Interface	ERA_ERTMS_015560
[Ref 12]	Dimensioning and Engineering rules	SUBSET-040
[Ref 13]	Glossary of Terms and Abbreviations	SUBSET-023
[Ref 14]	CCS Consist Network Communication Layers	SUBSET-147
[Ref 15]	Specific sub-system requirements (traction, braking, etc.) for EMU/DMU, locomotives and driving coaches (Rolling stock sub-system requirements, requirements for economic purposes, requirements for railway standardisation)	UIC 612-2

ERA * UNISIG * EEIG ERTMS USERS GROUP

Ref. N°	Title	Reference
[Ref 16]	Railway applications - Braking - Requirements for the brake system of trains hauled by locomotives	EN 14198
[Ref 17]	European Commission Regulation - TSI LOC&PAS	1302/2014
[Ref 18]	Train Interface FIS	SUBSET-034
[Ref 19]	ETCS System Version Management	SUBSET-104
[Ref 20]	Exceptions for on-board reduced envelopes of ETCS system versions	SUBSET-153

Table 2 Reference Documents

5.3 Abbreviations

5.3.1.1 For ATO related abbreviations see ERTMS/ATO Glossary [Ref 3].

5.3.1.2 For ETCS related abbreviations see SUBSET-023 [Ref 13].

5.4 Definitions

5.4.1.1 For ATO related definitions see ERTMS/ATO Glossary [Ref 3].

5.4.1.2 For ETCS related definitions see SUBSET-023 [Ref 13].

6. OVERVIEW

6.1 ERTMS/ATO Reference Architecture

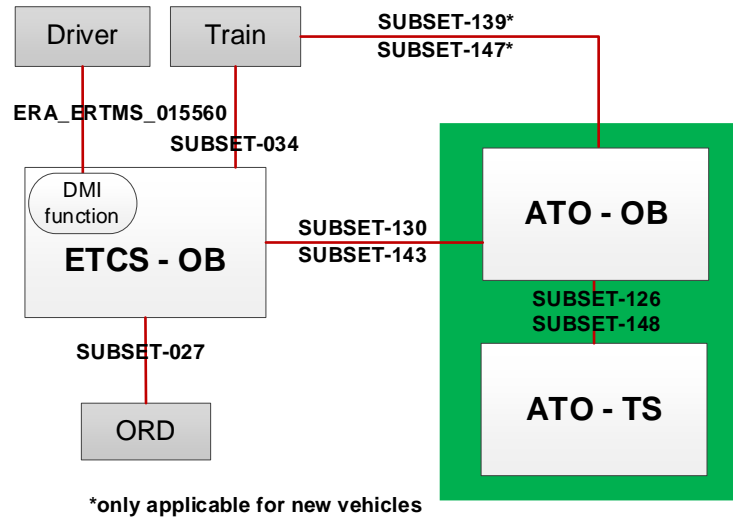

Figure 1 ERTMS/ATO reference architecture

6.2 Generic Requirements

- 6.2.1.1 The ATO-OB shall drive the train automatically while it is engaged.
- 6.2.1.2 **Note:** The ATO-OB can only be engaged by the driver.
- 6.2.1.3 The ATO-OB shall drive the train so as to respect the time table provided by ATO-TS without infringing the safe limits imposed by ETCS-OB (see §7.1).
- 6.2.1.4 The driver shall be able to drive manually the train while the ATO-OB is not engaged.
- 6.2.1.5 The ATO-OB shall not command the Emergency Brake.
- 6.2.1.6 When the train stops while the ATO-OB is engaged, the ATO-OB shall maintain the train stationary until the departure condition is fulfilled, which can be one of the following:
- a) if the train is stationary at a Stopping Point, the ATO-OB is going to EG State;
 - b) if the train is stationary but NOT at a Stopping Point, the MA allows the train to move.
- 6.2.1.7 The ATO-OB shall maintain the train stationary requesting to the train the application of the Train Holding Brake.
- 6.2.1.8 If the Train Holding Brake force is not sufficient to maintain the train stationary, the ATO-OB shall request to the train the application of the train brake in addition to the Train Holding Brake.

- 6.2.1.9 The train will provide a feedback related to actual application of Holding Brake.
- 6.2.1.10 If the train is not able to provide Holding Brake Application feedback (configuration parameter), the ATO-OB shall consider Holding Brake is applied after it has been commanded.
- 6.2.1.11 While the train is automatically driven, the ATO-OB shall disengage if the driver activates manually the brake via the TBL.
- 6.2.1.12 While it is engaged, the ATO-OB shall not take into account the traction commands coming from the driver. In consequence, if the driver commands traction manually via the TBL while the train is automatically driven, the ATO-OB shall remain engaged.
- 6.2.1.13 **Note:** The ATO-OB has no functionality regarding the execution of ETCS track conditions. This is a responsibility of ETCS-OB, external systems or the driver.
- 6.2.1.14 The ATO-TS shall inform the ATO-OB using the SPs or JPs, if it is not possible to apply traction, e.g. due to passing through a powerless section (i.e. current consumption limitation zone with a current limit value set to "0").
- 6.2.1.15 **Note:** The ATO-OB is not responsible to check the vigilance of the Driver's activity control function in accordance with clause 4.2.9.3.1 in [Ref 17]. This is a responsibility of an external system.
- 6.2.1.16 **Note:** The driver is responsible to verify that it is safe to begin automatic driving before starting automatic driving (e.g. passengers exchange completed, no obstacles, etc...).
- 6.2.1.17 The ATO-OB shall use the estimated train front end when determining train position information versus SP locations, unless otherwise specified in this document.
- 6.2.1.18 Regards stopping a train at an EOA (including temporary EOAs) it shall be possible to define in the SP a distance value as the stop location in rear of the EOA. Besides this distance value, the ability of the ATO-OB to stop the train accurately will determine the actual stop location.

6.3 Exported constraints

6.3.1 Train

- 6.3.1.1 **Exported constraint:** The installation of the ATO in the train shall ensure that a brake command from a Driver or an on-board safety system will take precedence over an ATO command.
- 6.3.1.2 **Note:** An on-board safety system that generates a brake command to Rolling Stock may be the Passenger Emergency Alarm (as defined in clause 4.2.5.3.3 in [Ref 17]).
- 6.3.1.3 **Exported constraint:** The installation of the ATO in the train shall ensure that ATO-OB is not able to apply traction when Emergency Brake is applied.

6.3.1.4 The ETCS-OB delivers to the train a binary information to report if the ETCS-OB is in AD mode or not, see detailed requirements in [Ref 18].

6.3.2 Infrastructure Manager

6.3.2.1 **Exported constraint:** The infrastructure manager shall guarantee the consistency between the ETCS track description and the data specified in the SP and JP.

6.3.2.2 **Exported constraint:** If any data is different depending on the train running direction, two different SPs shall be defined (one for each direction).

6.3.3 Train doors management

6.3.3.1 **Note:** The authorisation for the release of the doors will be performed in accordance with the clause 4.2.5.5.6 in [Ref 17].

6.3.3.2 **Exported constraint:** Driver's door commands shall always override the ATO door commands.

6.3.3.3 **Note.** In accordance with clause 4.2.5.5.7 in [Ref 17], Traction power will be applied only when all doors are closed and locked.

6.3.4 Control Centre

6.3.4.1 **Exported constraint:** The Control Centre shall be synchronised with an external source of UTC time.

6.4 Journey Profiles and Segment Profiles

6.4.1 Introduction

6.4.1.1 **Note:** A JP defines the route of a specific train by listing the SPs which will be travelled by the train.

6.4.2 Journey Profile (JP)

6.4.2.1 The ATO-TS shall send JPs to the ATO-OB containing:

- a) Status of the JP;
- b) Train route data including a list of:
 - 1) SP identifier;
 - 2) SP version;
 - 3) SP travelling direction.
- c) Operational data including a list of:
 - 1) TP identifier;
 - 2) Arrival time and tolerance;
 - 3) TP alignment;
 - 4) Daylight Saving Time information;
 - 5) TP type;
 - 6) Additional TP information;
 - End of Journey;
 - Stopping Point with Relaxed couplers.
 - 7) Departure time;
 - 8) Train Hold information;
 - 9) Minimum dwell time;
 - 10) Doors management information;
- d) Dynamic infrastructure data required to operate (Temporary Constraints) including a list of:
 - 1) Temporary Constraint type (ASR, Low Adhesion, ATO Inhibition Zone, Current Consumption Limitation Zone or DAS Inhibition Zone);
 - 2) Temporary Constraint location;
 - 3) ASR speed level and a qualifier which indicates if the supervision of the end of the speed restriction relates to the front or the rear end the train;
 - 4) Low adhesion rate (if applicable).

6.4.2.2 All location information shall be referred to a Segment Profile ID and given as a distance from the beginning of that SP, unless otherwise specified.

6.4.2.3 The JP shall include the list of SPs to be travelled by the ATO-OB in the order defined by the train movement.

ERA * UNISIG * EEIG ERTMS USERS GROUP

- 6.4.2.4 The ATO-OB shall use the travelling direction information to determine if the corresponding SP will be travelled in nominal or reverse direction.
- 6.4.2.5 The JP shall identify, for each Stopping Point, if the ATO-OB has to manage train doors opening (including the sides for opening the doors) and train doors closing.
- 6.4.2.6 When entering into a Low Adhesion Area, ATO Inhibition Zone, DAS Inhibition Zone, Current Consumption Limitation Zone, Dynamic Brake inhibition area, Dynamic Brake force limit area or ASR, the ATO-OB shall consider the restriction from the estimated front end of the train.
- 6.4.2.7 When leaving a Low Adhesion Area, ATO Inhibition Zone, Current Consumption Limitation Zone, Dynamic Brake inhibition area, Dynamic Brake force limit area or DAS Inhibition Zone the ATO-OB shall consider the end of the restriction from the estimated rear end of the train.
- 6.4.2.8 When leaving an ASR, the ATO-OB shall consider the end of the restriction depending on the value of the qualifier which indicates if the supervision of the end of the speed restriction relates to the front or the rear end the train.
- 6.4.2.9 If the TRN (Train Running Number) changes, the ATO-OB shall delete any stored JP and it shall send a new HSReq.
- 6.4.2.10 The JP shall list all time references of TPs in chronological order.
- 6.4.2.11 The identifier of a TP is composed of a country/region identity number and a TP identity number unique within the country/region.
- 6.4.2.12 A JP shall contain only one TP EoJ, which is the last TP of that JP.
- 6.4.2.13 The ASR shall include any TSR defined by the ETCS and may include any operational speed restriction requested by IM or RU.
- 6.4.2.14 The ATO-OB shall be able to process the maximum amount of data corresponding to at least one JP and associated SPs.
- 6.4.2.15 The ATO-OB shall be able store at least two maximum size JPs including the maximum number of referenced maximum size SPs.
- 6.4.2.16 When the train moves in the direction of the JP, storage capacity occupied by JP information in rear of the SP where the rear end of the train was located in the last acknowledged STR shall be made available immediately by the ATO-OB.
- 6.4.2.17 **Note:** The requirement is needed to allow ATO-TS to predict the storage capacity available on-board in order not to cause the minimum memory capacity of the ATO-OB to be exceeded.
- 6.4.2.18 The handing-over ATO-TS shall guarantee that the remaining minimum memory size available in the ATO-OB is at least 1 maximum size JP (including the maximum number

of referenced maximum size SPs) when a JP refers to the last Segment Profile containing the accepting ATO-TS contact information.

- 6.4.2.19 The accepting ATO-TS shall not send JP larger than the 1 maximum JP (including the maximum number of referenced maximum size SPs) until the train is completely within its ATO-TS area.

6.4.3 Segment Profile (SP)

- 6.4.3.1 The ATO-TS shall send SPs to the ATO-OB containing the static infrastructure data required to operate.

- 6.4.3.2 A SP shall contain the following information:

- a) SP identifier;
- b) SP version;
- c) SP Status;
- d) Length of the SP (shall not be zero);
- e) Distance to stop in rear of an EOA;
- f) Offset to compute the local time from the UTC time;
- g) Altitude at the beginning of the SP;
- h) Static Speed Profile;
- i) Gradient Profile;
- j) Curve Profile;
- k) Traction system information;
- l) Current Consumption Limitation Zone;

- 6.4.3.3 A SP shall also contain the following information when existing:

- a) Balises information;
 - 1) BG identifier;
 - 2) Position of the balise in the balise group;
 - 3) Balise location.
- b) TP information:
 - 1) TP Identifier;
 - 2) TP Location;
 - 3) Stopping tolerance;
 - 4) Stopping Point Reached distance;
 - 5) TP Name.
- c) Platform areas;
- d) Tunnel information;
- e) Axle Load Speed Profile;
- f) Stop in rear of an unprotected level crossing (according to the direction of the SP);
- g) Permitted Braking Distance;
- h) Switch off Regenerative Brake areas;
- i) Switch off eddy current brake for service brake areas;

- j) Switch off eddy current brake for emergency brake areas;
 - k) Switch off Magnetic Shoe Brake areas;
 - l) ATO-TS Contact Information.
 - m) Dynamic brake force limit area
 - n) Dynamic brake inhibition area
- 6.4.3.4 The identifier of an SP is composed of a country/region identity number and an identity number within the country/region.
- 6.4.3.5 The nominal direction of an SP is defined by the direction from beginning to end.
- 6.4.3.5.1 **Note:** An SP may be used in nominal or reverse direction (§6.4.2.4).
- 6.4.3.6 The SP definition shall ensure that two consecutive SPs are contiguous, i.e. there is no location gap nor overlap between them.
- 6.4.3.7 All location information shall be given as a distance from the beginning (nominal direction) of the SP, unless otherwise specified.
- 6.4.3.8 **Note:** Valid location values range between 0 (zero, inclusive) and the length of that SP (inclusive).
- 6.4.3.9 The ATO-OB shall consider the Stop in rear of an unprotected level crossing restriction from the front end of the train.
- 6.4.3.10 The distance to stop in rear of an EOA shall be given as a distance from the EOA.
- 6.4.3.11 Each SP shall have a unique identity number within an ETCS NID_C area.
- 6.4.3.12 The SP shall have a version number in order to detect if the Infrastructure Manager has brought some changes i.e. if an SP stored in the ATO-OB has become obsolete.
- 6.4.3.13 **Note:** On-board preloading of SPs may be implemented but the way to do it is not standardised (application specific).
- 6.4.3.14 For each data type, the list of items shall be included in increasing order of location starting from the beginning of the SP.

7. ATO FUNCTIONS

7.1 Driving Function

7.1.1 Introduction

7.1.1.1 The driving function of the ATO-OB is made up by the following functional features:

- a) Time Table Speed Management (TTSM) – See §7.1.2: establishes the optimum speed to achieve the Stopping or Passing Points on time in the most energy efficient way.
- b) Supervised Speed Envelope Management (SSEM) – See §7.1.3: establishes the maximum speed the train can run without interfering with the ETCS speed limits.
- c) Automatic Train Stopping Management (ATSM) – See §7.1.4: establishes the speed profile to stop the train accurately at the Stopping Points.
- d) ATO Traction / Brake Control – See §7.1.5: generates the output commands to drive the train according to the speeds given by the three preceding features.

7.1.1.2 **Note:** The following figure shows an overview of the functional features. This diagram does not describe the architecture.

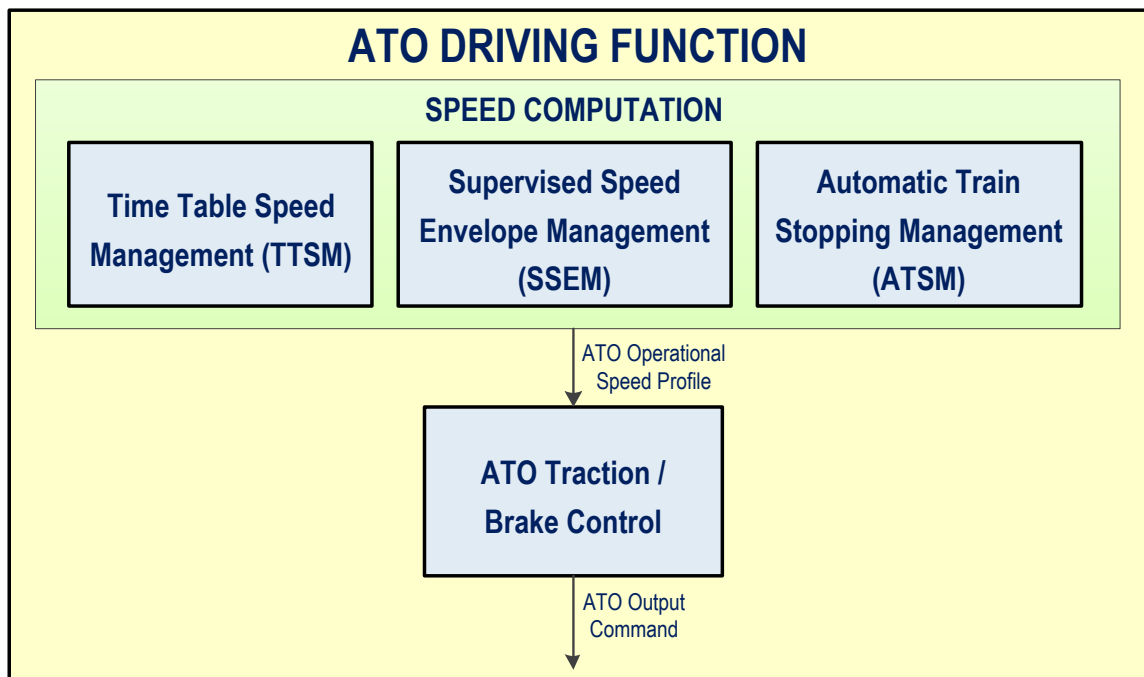

Figure 2 ATO driving function

7.1.2 Time Table Speed Management (TTSM)

7.1.2.1 The ATO-OB shall compute a Speed Profile (TTSM) which meets the arrival times (with a related tolerance) at the TPs (taking into account the TP alignment required) defined in the JP and minimises the energy consumption as much as possible. This Speed Profile is called "Optimum Speed Profile".

7.1.2.2 The ATO-OB takes into account the following information from the JP and SPs to compute the Optimum Speed Profile:

a) Speed Profile defined by:

- 1) Static Speed Profile depending on the Train Category;
- 2) Axle Load Speed Profile depending on the Axle Load Category;
- 3) ASR Speed level.

Note: This information forms an upper limit of computed optimum speed profile at each position of the train in the journey;

- b) TPs constraints define current timetable to be respected (including arrival/departure time, alignment position, skip request ...);
- c) Low adhesion areas define low adhesion categories from which ATO-OB deduces the corresponding acceleration/deceleration rates reduction;
- d) Altitude information is used for prediction of available power output of combustion engines;
- e) Gradient Profile is used for prediction of running resistance;
- f) Curve Profile is used for prediction of running resistance;
- g) Traction system information is used for prediction of traction/brake capabilities of the train;
- h) Current consumption limitation zone is used for prediction of traction / brake capabilities of the train;
- i) Tunnel information is used for prediction of running resistance;
- j) Stop in rear of an unprotected level crossing (according to the direction of the SP) is used to compute travel times including an enforced stop at unprotected level crossing;
- k) Permitted Braking Distance is used for prediction of speed supervised by ETCS-OB;
- l) Switch off Special Brake areas is used for prediction of speed curve supervised by ETCS-OB and for prediction of brake capabilities of the train.

7.1.2.3 The Optimum Speed Profile shall be calculated, and kept updated, e.g. taking into account the current position and speed of the train.

7.1.2.4 The ATO-OB shall determine the Static Speed Profile to use by comparing the Train Category information received from the ETCS-OB with the Static Speed Profile information included in the SP.

- 7.1.2.5 The ATO-OB shall determine the Axle Load Speed Profile to use by comparing the Axle Load Category information received from the ETCS-OB with the Axle Load Speed Profile information included in the SP.
- 7.1.2.6 The ATO-OB shall determine the applicable Speed Profile until the next Stopping Point from the following information:
- a) Static Speed Profile;
 - b) Axle Load Speed Profile;
 - c) Maximum train speed;
 - d) Train length;
 - e) ASR.
- 7.1.2.7 The ATO-OB shall take into account the predicted EBI supervision limits (see §7.1.3.8) to compute the Optimum Speed Profile.
- 7.1.2.8 To compute the Optimum Speed Profile, the ATO-OB shall select the applicable normal service braking model(s) from:
- a) The brake position and;
 - b) The full service brake deceleration(s) at zero speed depending on:
 - 1) The applicable full service braking model(s) defined by:
 - I. The “index for trains on which the braking models are captured as Train Data” (See §7.13.1.3) and;
 - II. The combination(s) of use of regenerative brake and eddy current brake (See §7.13.1.4),for trains on which the braking models are captured as Train Data or;
 - 2) The brake percentage if it is captured as Train Data and the conversion model is applicable,according to the clauses [Ref 5] §3.13.2.2.3.1.9 and §3.13.2.2.3.1.10.
- 7.1.2.9 **Note:** The way to use the information listed above in order to determine the Optimum Speed Profile is supplier specific.

7.1.3 Supervised Speed Envelope Management (SSEM)

- 7.1.3.1 The ATO-OB shall compute the maximum speed (SSEM) the train can run avoiding ETCS intervention.
- 7.1.3.2 When the ETCS-OB is in ceiling speed monitoring, the ATO-OB shall drive the train at a speed lower than or equal to the ETCS permitted speed received from the ETCS-OB.
- 7.1.3.3 When the ETCS-OB is in target speed monitoring, the ATO-OB shall drive the train so as not to reach the ETCS EBI intervention limit received from the ETCS-OB.

ERA * UNISIG * EEIG ERTMS USERS GROUP

- 7.1.3.4 **Note:** When in AD Mode and target speed monitoring, the ETCS-OB inhibits the SB command triggered by overpassing an SBI supervision limit.
- 7.1.3.5 **Note:** While in AD Mode, the ETCS-OB inhibits the Sinfo sound, the over-speed sound and the warning sound in relation to speed and distance monitoring.
- 7.1.3.6 When the ETCS-OB is in release speed monitoring, the ATO-OB shall drive the train at a speed lower than or equal to the ETCS release speed received from the ETCS-OB.
- 7.1.3.7 The ATO-OB shall compute the EBD curves within the current MA as defined in [Ref 5] §3.13.8.3, using the information sent by the ETCS-OB:
- Value of safe deceleration ($A_{safe}(V,d)$) computed by the ATO-OB as defined in [Ref 5] §3.13.6.2.1.3 from:
 - $A_{GRADIENT}(d)$;
 - $A_{MAXREDADH}(d)$;
 - $A_{BRAKE_SAFE}(d,V)$.
 - MRSP;
 - Distance to the EOA or LOA currently supervised by the ETCS-OB;
 - Permitted speed at the EOA or LOA currently supervised by the ETCS-OB;
 - Distance to the SvL.
- 7.1.3.8 The ATO-OB shall predict an estimation of the EBI supervision limits based on the computed EBD curves based on [Ref 5] §3.13.9.3.2, using the following information sent by the ETCS-OB:
- Time during which the traction effort is still present after the Emergency brake intervention;
 - Brake reaction time during which the braking effort is not yet present after the Emergency brake intervention;
 - Remaining time during which the traction effort is not present until the equivalent brake build up time elapses after the Emergency brake intervention;
 - Compensation of the inaccuracy of the speed measurement;
 - Current estimated train speed;
 - Current estimated train acceleration.
- 7.1.3.9 The ATO-OB shall stop the train at a distance in rear of an EOA, as defined in the SP.
- 7.1.3.10 **Note:** The algorithm to establish the ATO maximum speed within the ETCS target, ceiling and release speed limits is supplier specific.
- ### 7.1.4 Automatic Train Stopping Management (ATSM)
- 7.1.4.1 The ATO-OB shall define the speed profile (ATSM) to stop the train automatically at the Stopping Points (taking into account the TP alignment required in the JP).

- 7.1.4.2 The ATO-OB shall consider the stopping window of a Stopping Point as the Stopping Point location \pm the required stopping tolerance mentioned in the SP.
- 7.1.4.3 The JP, sent from the ATO-TS, shall identify the required Stopping Points of the train from the list of TPs included in the SP (which contain their position). It shall also define if the train has to align to each Stopping Point with its front, its middle or its rear end.
- 7.1.4.4 **Note:** The ATO-OB disengages when it stops the train at a Stopping Point considered as reached independently of whether the ATO-OB has stopped the train within the stopping window or not. It is therefore a manual operation, by the driver, to align the train or to take other actions, if necessary, depending on local procedures.
- 7.1.4.5 **Note:** The algorithm to establish the ATSM Speed Profile is supplier specific.

7.1.5 ATO Traction / Brake Control

- 7.1.5.1 The ATO Traction / Brake Control generates the ATO output commands in order to follow the ATO Operational Speed Profile defined from TTSM, ATSM and SSEM. The train will use these commands to control traction and brakes.
- 7.1.5.2 The ATO-OB shall take into account the following information from the JP and SPs affecting the Traction or Brake effort limits in order to compute the traction/braking commands:
- a) Low adhesion areas;
 - b) Current consumption limitation zone (including powerless section);
 - c) Switch off Regenerative Brake areas;
 - d) Switch off eddy current brake for service brake areas;
 - e) Switch off eddy current brake for emergency brake areas;
 - f) Switch off Magnetic Shoe Brake areas.
- 7.1.5.3 To compute the traction/braking commands, the ATO-OB shall take into account the following information:
- a) The nominal rotating mass (if available);
 - b) The currently applicable normal service braking model selected from:
 - 1) The brake position and;
 - 2) The full service brake deceleration at zero speed depending on:
 - I. The applicable full service braking model defined by:
 - I.I. The "index for trains on which the braking models are captured as Train Data" (See §7.13.1.3) and;
 - I.II. The current combination of use of regenerative brake and eddy current brake (See §7.13.1.4),
for trains on which the braking models are captured as Train Data or;
 - II. The brake percentage if it is captured as Train Data and the conversion model is applicable,

according to the clauses [Ref 5] §3.13.2.2.3.1.9 and §3.13.2.2.3.1.10.

- 7.1.5.4 **Note:** Traction and brake outputs should be adapted to the train characteristics to enable control of the vehicle maintaining adequate acceleration/deceleration and jerk limitation. This adaptation is application specific.
- 7.1.5.5 **Note:** The ATO-OB should aim to reduce the transitions between traction and braking. The actual requirement related to this transition minimisation is supplier and application specific.
- 7.1.5.6 **Note:** The interface to transmit the output from ATO-OB to the train is specified in [Ref 9].
- 7.1.5.7 For S-type trains, the ATO-OB shall consider the “dynamic brake force limit area” defined in SP when regulating the train speed throughout this area.
- 7.1.5.8 For S-type trains, the ATO-OB shall request for a Full Service Brake by requesting the maximum train brake and, if applicable, the maximum dynamic brake, respecting current dynamic brake force limits.
- 7.1.5.9 For S-type trains when applicable for a given vehicle: if the dynamic brake is requested and not confirmed by the train, then the ATO-OB shall use the train brake instead.
- 7.1.5.10 When applicable for given vehicle: if the locomotive brake is requested and not confirmed by the train, then the ATO-OB shall use the train brake instead.
- 7.1.5.11 When applicable for given vehicle: if the holding brake is requested and not confirmed by the train, then the ATO-OB shall use the train brake instead.
- 7.1.5.12 **Note:** The rest of this section contains driver craftsmanship acts which should be considered by the ATO-OB.
- 7.1.5.13 For S-type trains, if the ATO-OB is configured to manage the dynamic brake, the maximum permitted dynamic brake force realised by locomotive alone or in multiple traction should not exceed the values defined in the following formulae due to the maximum longitudinal force in the train.
- $V \leq 30$ km/h: $F_{dyn}[kN] = 150$ KN;
 - $30 < V \leq 60$ km/h: $F_{dyn}[kN] = 40$ KN + $3,67 \times V$ [km/h];
 - $V > 60$ km/h: $F_{dyn}[kN] = 260$ KN.
- Where V is current speed
(refer to [Ref 15] 4.3.3.1)
- 7.1.5.14 **Note:** the train is configured to manage the dynamic brake limits if the relevant data are available at train level.
- 7.1.5.15 For S-type trains, the ATO OB should send a quick brake release request when necessary to guarantee that the train brake is released before applying traction or

ERA * UNISIG * EEIG ERTMS USERS GROUP

coasting. The ATO-OB should consider that the train brake is completely released when the train brake release time is elapsed, where train brake release time is defined according to the following Table 3:

<i>brake release</i>	<i>type of train</i>					
	<i>passenger, P position</i>		<i>freight, P position</i>		<i>freight, G position</i>	
	<i>standard</i>	<i>EP</i>	<i>standard</i>	<i>EP</i>	<i>standard</i>	<i>EP</i>
<i>by using high pressure filling stroke</i>	25 s	15 s	25 s	20 s	75 s	20 s
<i>by using release position only</i>	40 s	15 s	60 s	20 s	120 s	20 s

Table 3 Train brake release time

- 7.1.5.16 The train should give a feedback on the way the quick brake release has been applied including the details whether it is realised by means of high pressure filling stroke or overcharging feedback. When the train is not able to provide such a feedback, then the ATO-OB should always consider the highest possible value belonging to the category for the train brake release time.
- 7.1.5.17 To start S freight trains on flat track or small gradient (when holding brake is sufficient to immobilise the train), the ATO-OB should
- a) Release the train brake if it is still applied (after manual train stop), and possibly send a quick brake release request to guarantee that the indirect brake is released before applying traction;
 - b) Wait that the train brake is completely released;
 - c) Start commanding traction (while holding brake is still applied by the train).
- 7.1.5.18 **Note:** The train will automatically release the holding brake when traction is applied.
- 7.1.5.19 To start S passengers trains on flat track or small gradient (when holding brake is sufficient to immobilise the train), the ATO-OB should
- a) Release the train brake if it is still applied (after manual driving before stop);
 - b) Wait that the train brake is completely released;
 - c) Start commanding traction (while holding brake is still applied by the train).
- 7.1.5.20 **Note:** The train will automatically release the holding brake when traction is applied.
- 7.1.5.21 To start S-type trains on steep incline (in which the holding brake force is not sufficient to maintain the train stationary), the ATO-OB should:

- a) Request from the train the authorisation to apply traction over brake;
 - b) Wait until the authorisation to apply traction over brake is given by the train;
 - c) Start process of releasing the train brake;
 - d) Start commanding traction according to the actual degree of the train brake release to prevent roll-back.
- 7.1.5.22 **Note:** The train will automatically release the holding brake when traction is applied.
- 7.1.5.23 To start S-type trains on steep slope down (in which the holding brake force is not sufficient to maintain the train stationary), the ATO-OB should:
- a) Start the process of releasing the train brake (the train starts to move and accelerates downhill due to gravity while the train brake is releasing);
 - b) Release the holding brake at the same time as the train brake;
 - c) Start commanding traction when the train brake release time is elapsed.
- 7.1.5.24 The ATO-OB should apply the following rules for using the brake on S-type trains:
- a) If the train consist of a locomotive only, the ATO-OB should not exclusively use the dynamic brake when braking to standstill at an EOA.
 - b) For other trains (traction units with at least one wagon), the ATO-OB should not use the locomotive brake as long as standstill is not reached. As an exception the locomotive brake is allowed to be used when braking to a Stopping Point is configured with the attribute “relaxed couplers”.
 - c) For other trains (traction units with at least one wagon), the ATO-OB is allowed to exclusively use the dynamic brake only when the speed is higher than a train specific value defined on-board.
- 7.1.5.25 The ATO-OB should apply the following rule for using the brake on all trains:
- a) The ATO-OB should be configured to ignore or to respect dynamic brake inhibition.
 - b) If configured to do so, the ATO-OB should request the train to not use dynamic brake when being in a dynamic brake inhibition area.
- 7.1.5.26 Driving on a steep slope, the ATO-OB possibly needs to adapt the train brake effort in order to prevent the train brake exhaustion (see [Ref 16] section 5.4.4.2).
- 7.1.5.27 When starting on steep incline, the ATO-OB should start applying traction before releasing the train brake in order to prevent the train rolling-back if traction over brake is enabled.

7.2 Timing Point Management

7.2.1 Timing Point states

- 7.2.1.1 A Stopping Point can be considered as not used, targeted, reached or passed. These states are mutually exclusive.

- 7.2.1.2 A Passing Point (or Stopping Point to be skipped) can be considered as not used, targeted or passed. These states are mutually exclusive.
- 7.2.1.3 Upon reception of a JP, the ATO-OB shall consider the first TP in advance of the train as the targeted one and all the other ones in advance of the train as not used.
- 7.2.1.4 The ATO-OB shall consider a targeted Stopping Point as reached when it has stopped (manually or automatically) within a distance in rear of or in advance of the Stopping Point (taking into account the TP alignment required in the JP). This Stopping Point Reached distance is configured in the SP.
- 7.2.1.5 The ATO-OB shall consider a Stopping Point as passed when any of the following conditions are fulfilled:
- a) For manually driven trains, the train has passed the “Stopping Point reached distance” beyond the Stopping Point (taking into account the Timing Point alignment required in the JP);
 - b) For automatically driven trains, the Stopping Point is considered as reached and the ATO-OB enters EG State;
 - c) The Stopping Point is considered as reached, the speed of the train is greater than 10 km/h and the train has passed the Stopping Point location (taking into account the TP alignment required in the JP).
- 7.2.1.6 A Passing Point (or Stopping Point to be skipped) shall be considered as passed when the train has passed the location of the TP (taking into account the Timing Point alignment required in the JP).
- 7.2.1.7 Once a TP is considered as passed, the next TP, if any, shall be the targeted TP managed by the ATO-OB.
- 7.2.1.8 Once a Stopping Point is considered as passed the next Stopping Point (or Stopping Point to be skipped) information, if any, shall be displayed on the DMI (see §8.2.7), but may not be the targeted TP yet if there are Passing Points in between.

7.2.2 Train Door Operation (TDO)

- 7.2.2.1 The Train Door Operation (TDO) shall provide the opening and closing commands/information of train doors for passenger exchange.
- 7.2.2.2 If the JP requests the ATO-OB to manage the doors opening, the doors opening process may allow the following alternatives depending on static train configuration:
- a) Manual door opening command executed by the driver following the displayed ATO-OB information (see §8.2.4.1);
 - b) Automatic door opening command sent by the ATO-OB to the train in accordance with the information contained in the JP i.e. either:
 - 1) To provide doors opening after passengers' request. Individually for each door and depending on the train door release or;

2) To provide automatic centralised door opening.

- 7.2.2.3 If the JP requests the ATO-OB to manage the doors closing, the doors closing process may allow the following alternatives depending on static train configuration:
- a) Manual door closing command executed by the driver following the displayed ATO-OB information (see §8.2.4.4);
 - b) Automatic door closing command sent by the ATO-OB to the train.
- 7.2.2.4 The ATO-OB shall send an automatic door opening command to the train door management system when the following conditions are fulfilled:
- a) Static train configuration allows automatic train doors opening;
 - b) The ATO-OB is in EG State;
 - c) The train is at standstill;
 - d) The ATO-OB expects the train to stop within the stopping window of a Stopping Point.
- 7.2.2.5 Depending on the “centralised opening” information received in the JP, the ATO-OB shall send the automatic door opening command to:
- a) Provide doors opening after passengers’ request individually for each door or;
 - b) Provide automatic centralised door opening.
- 7.2.2.6 When the remaining dwell time is equal to the train configuration time to perform normal door closure procedure, the ATO-OB shall send an automatic door closing command to the train door management system if the following conditions are fulfilled:
- a) Static train configuration allows automatic train doors closing;
 - b) The ETCS-OB is in AD Mode.
- 7.2.2.7 **Note:** The management of doors that become obstructed when closing is outside the scope of the ATO-OB.
- 7.2.2.8 The following picture shows the options for doors opening/closing previously described.

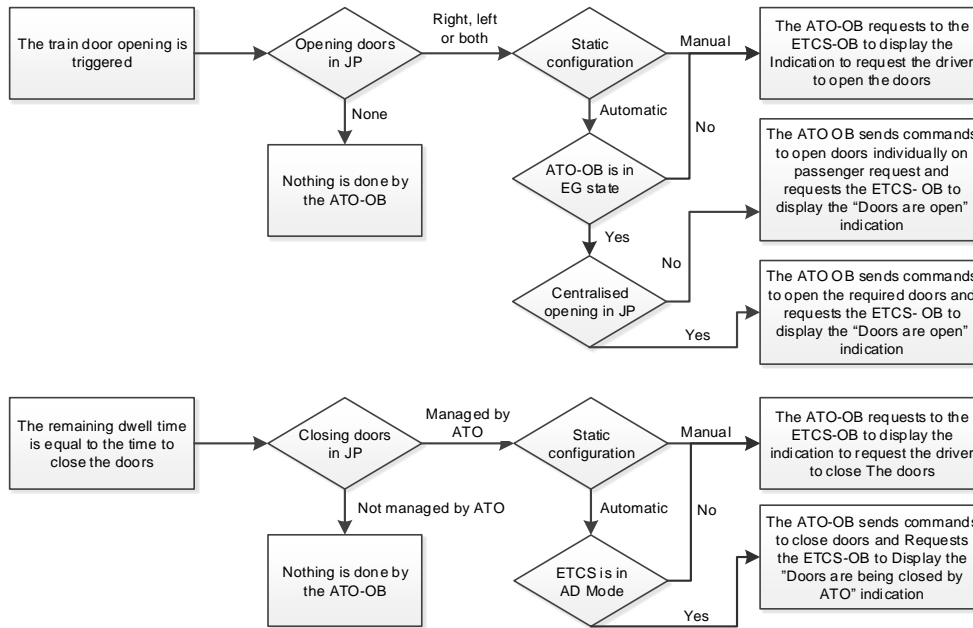

Figure 3 Door operation diagrams

7.2.2.9

Note: Based on the previous requirements, the TDO operates according to the following scenario:

- a) When the train is at standstill and the ATO-OB expects the train to stop within the stopping window of a Stopping Point;
 - 1) If the ATO-OB is in EG State and the static configuration allows automatic door opening, the ATO-OB provides to the train door system the train doors opening commands or the possibility to open doors after passenger request, on the side(s) defined in the JP or;
 - 2) If the ATO-OB is not in EG State or the static configuration requests manual door opening, when the train stops within the stopping window, the ATO-OB requests to the ETCS-OB to display the indication to request the driver to open doors defined in the JP.
- b) A safe system enables the release of the appropriate doors on the correct side(s) (it may take place after the actual stop of the train, not in the scope of ATO-OB);
- c) When the train stops, the ATO-OB requests the application of the Train Holding Brake and disengages automatic driving;
- d) The ATO-OB starts the count-down of the dwell time;
- e) When the remaining dwell time is equal to the train configuration time to perform normal door closure procedure:
 - 1) If the ETCS-OB is in AD Mode and static configuration allows automatic door closing, the ATO-OB sends automatically the door closing commands to the train door system or;
 - 2) If the ETCS-OB is not in AD Mode or the static configuration requests manual door closing, the ATO-OB requests to the ETCS-OB to display the indication to request the driver to close doors.

7.2.2.10 **Note:** The interface to transmit the output from ATO-OB to the train is specified in [Ref 9].

7.2.3 Dwell time Management

7.2.3.1 While a Stopping Point is considered as reached, each time the train stops or an updated JP modifying the departure time of that Stopping Point is received:

- a) The ATO-OB shall compute the dwell time as the difference between the departure time given by the JP and the time at which the train is stopped with a minimum value corresponding to the minimum dwell time given in the JP.
- b) The ATO-OB shall start a countdown starting from the computed dwell time (remaining dwell time).

7.2.3.2 Once the dwell time is expired, the displayed remaining dwell time shall remain at zero.

7.2.3.3 If the JP requests to hold the train at a Stopping Point (see §7.4), while the train is stopped at the corresponding Stopping Point, the dwell time shall be set to hold and shall not be considered as elapsed while the Train Hold at Stopping Point is requested.

7.2.3.4 If there is any remaining dwell time or the dwell time is set to hold, the dwell time shall be set to "0" (elapsed) when the train is moving with a speed greater than 10 km/h.

7.2.3.5 **Note:** The purpose of the speed limit is to avoid a reset of the dwell time if the driver is, e.g. jogging to adjust the stopping position of the train.

7.3 Add/skip Stopping Point

7.3.1.1 The ATO-TS may add additional Stopping Points or request to skip Stopping Points in real time by updating the JP.

7.3.1.2 Any newly received Stopping Point shall be ignored if the distance to the new TP is not sufficient for the ATO-OB to stop the train (supplier specific) or the TP is already passed. In this case, the ATO-TS shall be informed.

7.3.1.3 When it requests the skipping of a Stopping Point, the ATO-TS shall update the JP marking the Stopping Point in question as a Stopping Point to be skipped.

7.3.1.4 The ATO-TS shall be able to revoke a Stopping Point skip that it had requested before by means of a JP Update.

7.3.1.5 The ATO-OB shall allow the driver to request to skip the next Stopping Point when the ATO-OB is in AV, RE, EG or DE State, the next Stopping Point is not already considered as a Stopping Point to be skipped and the doors are closed and locked, unless the train is stopped at a Stopping Point considered as reached.

7.3.1.6 While the driver requests to skip the next Stopping Point, the ATO-OB shall consider that Stopping Point as a Stopping Point to be skipped.

- 7.3.1.7 Once the driver has requested to skip the next Stopping Point, the ATO-OB shall store that Stopping Point skip request until one of the following conditions is met:
- a) The concerned Stopping Point is passed;
 - b) The driver revokes his/her own Stopping Point skip request;
 - c) Further to a JP update, the concerned Stopping Point is no longer the next stopping point referred to in the JP;
 - d) Further to a JP update, the concerned Stopping Point is requested to be skipped by TS in the JP.
- 7.3.1.8 As long as the Stopping Point skip request by driver is stored, the driver shall be allowed to revoke this Stopping Point skip request.
- 7.3.1.9 When Stopping Point skipping is requested or revoked by the driver, the ATO-TS shall be informed.
- 7.3.1.10 For Operational Speed Profile computation purposes, the ATO-OB shall consider a Stopping Point to be skipped as a Passing Point.
- 7.3.1.11 **Note:** If skipping a Stopping Point at a platform requires a special speed limit for passing through the platform, ATO-TS can transmit an ASR in the “JP Update”.

7.4 Train Hold at a Stopping Point

- 7.4.1.1 The ATO-TS shall be able to request Train Hold at a Stopping Point by means of a JP Update.
- 7.4.1.2 **Note:** The Control Centre may require Train Hold (via JP Update) for operational reasons for one or several trains.
- 7.4.1.3 When Train Hold is requested, this information shall be displayed on the DMI in such a way that the driver is clearly advised about it.

7.5 Low Adhesion Management

- 7.5.1.1 When low adhesion is selected by the driver, this information shall be sent by the ATO-OB to the ATO-TS.
- 7.5.1.2 When the ATO-OB is informed about “slip/slide” from an external system, this information shall be sent to the ATO-TS.
- 7.5.1.3 **Note:** Slip/slide information is used by the ATO-OB for diagnostic purposes.

- 7.5.1.4 If Control Centre provides the functionality to advise ATO-TS about areas of reduced adhesion, the ATO-TS shall inform the concerned trains about the “Low adhesion Area” via the JP.
- 7.5.1.5 The ATO-OB shall adapt the ATO Operational Speed Profile and traction / braking commands according to the “adhesion category” transmitted via the JP.
- 7.5.1.6 When it receives a JP without low adhesion information, the ATO-OB shall consider the adhesion as the condition non slippery rail.

7.6 Time Management

- 7.6.1.1 The ATO-OB and ATO-TS shall use the UTC Time with an accuracy of ± 1 second.
- 7.6.1.2 All the time variables included in the ATO packets (e.g. timestamp, estimated arrival time...) shall be in UTC, unless otherwise specified.
- 7.6.1.3 ATO-OB shall be able to convert UTC Time to Local Time in order to display to the driver the arrival time to upcoming Stopping Points.
- 7.6.1.4 **Note:** The Local Time is defined as:
Local Time = UTC Time + UTC Time Zone Offset + Daylight Saving Time, where:
- Coordinated Universal Time (UTC) is the current reference time.
 - UTC Time Zone Offset is the difference in minutes from UTC Time for a place and date ([Ref 7]).
 - Daylight Saving Time (DST) is the practice of setting the clocks forward one hour from standard time during the summer months, and back again in the fall, to make better use of natural daylight.
- 7.6.1.5 **Note:** The UTC Time Zone Offset value is indicated in the SP; while the Daylight Saving Time is indicated in the JP.

7.7 Reporting Management

- 7.7.1.1 The ATO-OB shall send STRs to an ATO-TS from the moment it has received a JP from that ATO-TS until the last TP included in the JP received from that ATO-TS is considered as passed unless otherwise specified.
- 7.7.1.2 While being in FA State, the ATO-OB shall try to send STRs to an ATO-TS regardless the other conditions.
- 7.7.1.3 If an acknowledgement to the previous STR has been received, or if this is the first STR following a Communication Session establishment, the ATO-OB shall send an STR to the ATO-TS when:
- a) There is a change of the ATO Operation State;

ERA * UNISIG * EEIG ERTMS USERS GROUP

- b) There is a change of one of the indicators (See §7.7.1.6 g));
 - c) The reporting time interval for triggering an STR is elapsed (if cyclic reporting is configured);
 - d) The train passes a Passing Point;
 - e) The length of the train has changed.
- 7.7.1.4 The ATO-OB may combine several triggering conditions in one STR, but it shall send an STR at the latest one second after the condition has been detected.
- 7.7.1.5 The reporting time interval for triggering an STR shall restart after an STR is sent (either event-based or cyclical).
- 7.7.1.6 The ATO-OB shall inform the ATO-TS about:
- a) The current ATO-OB State;
 - b) The speed of the train at the moment the STR is sent;
 - c) Train position information:
 - 1) SP identifier;
 - 2) The position of the estimated front end of the train, in relation to the beginning of the SP at the moment the STR is sent.
 - d) The following information concerning the most recent TP considered as either reached or passed:
 - 1) TP identifier;
 - 2) Qualifier to indicate if the train stopped, departed or passed the TP (see §7.7.1.71.1.1.a) 8));
 - 3) In case of stopping, if the train stopped within the stopping window.
 - e) The estimated arrival time to, at least, the next TP belonging to its current JP:
 - 1) TP identifier;
 - 2) Estimated arrival time.
 - f) The Driver ID;
 - g) The following indicators:
 - 1) JP-SP inconsistency;
 - 2) Routing Error;
 - 3) Next Stopping Point Skip;
 - 4) Low adhesion reported by the driver;
 - 5) Slip/Slide information detected by external system;
 - 6) Operational conditions fulfilment;
 - 7) Train is moving;
 - 8) Unable to stop at the next Stopping Point;
 - h) The length of the train.
- 7.7.1.7 The “qualifier to indicate if the train stopped, departed or passed the TP” shall be set to:
- a) “Stopped” from the first time the train stops at a Stopping Point considered as reached until that Stopping Point is considered as passed;

- b) “Departed” while the condition a) is not fulfilled and the last TP considered as passed is a Stopping Point;
 - c) “Passed” while the condition a) is not fulfilled and the last TP considered as passed is a Passing Point or Stopping Point to be skipped.
- 7.7.1.8 The ATO-TS shall send an STRAck packet to the ATO-OB as an answer to each STR received using the timestamp and the packet counter information of that STR.

7.8 Data Consistency Management

7.8.1 Introduction

7.8.1.1 The ATO-OB shall detect data inconsistency when:

- a) A Routing Error or;
- b) A Segment and Journey Profiles Consistency Error, is detected.

7.8.1.2 If ATO-OB detects any data inconsistency:

- a) The ATO-OB shall inform the ATO-TS about inconsistency through the STR;
- b) The ATO-OB shall not use inconsistent data.

7.8.2 Routing Errors

7.8.2.1 An ATO-OB which has located the train in an SP included in the current JP shall detect a Routing Error:

- a) When the identifier of the next balise group announced in the ETCS Linking Information received from the ETCS-OB is not included in the balise groups listed in the SPs referenced by the JP, AND
- b) The remaining distance to this next balise group does not exceed the remaining distance covered by the JP, AND
- c) This next balise group is not announced as “unknown but containing repositioning information”.

7.8.2.2 The ATO-OB shall lose the ATO Operational Conditions when a Routing Error is detected.

7.8.3 Segment and Journey Profiles Consistency Error

7.8.3.1 The ATO-OB shall detect Segment and Journey Profiles Consistency Error if:

- a) TP included in the JP is not found in the corresponding SP;
- b) The ATO-TS sends an SP with the status “invalid”;
- c) Time references of TPs listed in the JP are equal, or not in ascending order;

ERA * UNISIG * EEIG ERTMS USERS GROUP

- d) The SP does not provide the location values in increasing order for any profile data type;
- e) Any location data given in an SP is longer than the length of the SP;
- f) Any length data given in the SP is zero;
- g) The SP version of an SP received is not the one included in the corresponding JP.

7.8.3.2 If Segment and Journey Profiles Consistency Error is detected, the ATO-OB shall lose the ATO Operational Conditions when data inconsistency affects the journey to the next TP.

7.9 ATO System Version Management

7.9.1 Introduction

7.9.1.1 The ATO shall have a version number which will be transmitted in the ATO-OB/ATO-TS interface in order to support ATO backward compatibility.

7.9.1.2 The evolution of the versions of the ATO system shall be sequential, i.e. there shall only be one direct upgrade of an existing version and no branch is accepted.

7.9.1.3 The ATO system version shall be identified by a version number which complies with the following:

- a) Each version number will have the following format: X.Y;
- b) The first number (major version) distinguishes incompatible versions;
- c) The second number (minor version) indicates compatibility within a major version X;
- d) If the first numbers of two versions are the same, this indicates that those versions are compatible, independently of the second number.

7.9.1.4 The major version will be increased in case of a non-compatible change.

7.9.1.5 The minor version will be increased in case of a compatible change.

7.9.1.6 The ATO-OB and the ATO-TS may support several major ATO system versions.

7.9.2 Compatibility/Incompatibility criteria

7.9.2.1 The compatibility/incompatibility between two consecutive ATO system versions is established by analysing the relationship between an ATO-OB operating one system version and an ATO-TS operated with the other one.

7.9.2.2 In the following sections, version A is the existing system version, while version B is the subsequent system version, for which the compatibility/incompatibility is to be determined.

7.9.2.3 The version B is compatible with version A if both following conditions are met:

- a) a train operating version A can run a normal service on trackside infrastructure operated with version B;
- b) a train operating version B can run a normal service on trackside infrastructure operated with version A.

7.9.2.4 Conversely, the version B is incompatible with version A if one of following conditions is met:

- a) there is a technical, operational or safety related obstacle preventing a train operating version A from running a normal service on a trackside infrastructure operated with version B;

- b) there is a technical, operational or safety related obstacle preventing a train operating version B from running a normal service on a trackside infrastructure operated with version A.
- 7.9.2.5 The expression “train running a normal service” shall be understood as “train which is not penalised because of a reduction of performance or safety”.

7.9.3 Use of the ATO system version

- 7.9.3.1 On setting up a communication session between ATO-OB and ATO-TS equipment, the ATO-OB shall send its major ATO system version(s) and for each of them the corresponding highest supported minor version.
- 7.9.3.2 The ATO-TS shall answer with the ATO system version that will be used by the ATO-TS for the ATO-OB/ATO-TS communication. The major version to be used by the ATO-TS shall be the highest supported by both ATO-OB and ATO-TS.
- 7.9.3.3 The ATO-OB shall use the same major ATO system version as the ATO-TS for the track/train communication.
- 7.9.3.4 Within one of its supported system version numbers X, the ATO-OB shall always operate the highest system version number Y it supports, regardless of the system version number Y transmitted by the ATO-TS.
- 7.9.3.5 If no major ATO system version is supported by both ATO-OB and ATO-TS, the ATO-TS shall answer with a “no compatible” value of the ATO system version to be used and the communication shall be terminated.

7.9.4 Envelopes of system versions

7.9.4.1 ATO-TS - envelope of legally operated system versions

- 7.9.4.1.1 The system version number X, which an ATO-TS is allowed to operate with, shall be 1.
- 7.9.4.1.2 Within system version number X = 1, the system version number Y that an ATO-TS is allowed to use shall be any of the following: 0 or 1.
- 7.9.4.1.2.1 Note: for the relevancy of this clause to the ATO-TS, see [Ref 19] § 4.5.1.2, which can be applied by analogy for the ERTMS/ATO system.

7.9.4.2 ATO-OB – allowed envelopes of supported system versions

- 7.9.4.2.1 The highest system version number supported by the ATO-OB shall be one of the following: 1.0 or 1.1.

7.9.5 ATO-OB system version vs. ETCS-OB system version

7.9.5.1 Only the ATO-OB ⇔ ETCS-OB combinations listed in the Table 3a below shall be allowed, where the system version number X.Y indicates the highest system version supported by the ATO-OB/ETCS-OB.

Possible combinations of system version number X.Y
ATO-OB 1.0 ⇔ ETCS-OB 2.2
ATO-OB 1.1 ⇔ ETCS-OB 3.0

Table 3a ATO-OB/ETCS-OB possible system version number combinations

7.9.5.2 In case the ATO-OB, whose highest supported system version is 1.0, is interfaced to an ETCS-OB 2.2 (i.e. an ETCS-OB that supports a reduced envelope of ETCS system versions, which includes all the ETCS system versions from 1.0 up to 2.2), see [Ref 20] for the applicable exceptions.

7.10 ATO-OB Train Position Determination

7.10.1.1 The ATO-OB shall determine the train position within an SP from:

- a) The most recently received value of the position counter;
- b) The position counter at the moment a balise contained in an SP referred to in the current JP was passed;
- c) The balise position given in the SP;
- d) The distance from the antenna to the train front end;
- e) The distance travelled during the estimated time elapsed since the time at which the position counter was determined.

7.10.1.2 **Note:** The estimated time elapsed since the time at which the position counter was determined (see §7.10.1.1e)) considers:

- a) The time elapsed between the time at which the position counter was determined and the packet timestamp and;
- b) The estimated time elapsed since the packet was received.

7.10.1.3 The following figure presents how the ATO-OB determines the train position within an SP using the data defined in §7.10.1.1:

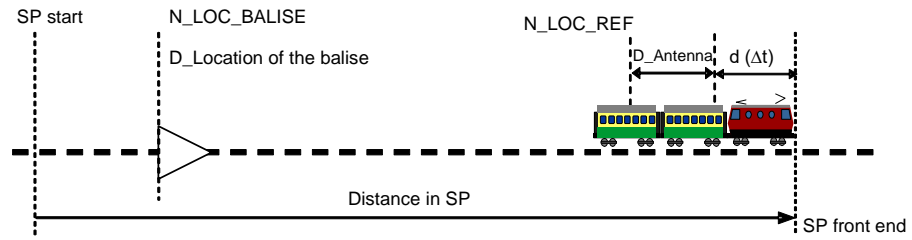

Figure 4 Train position within the SP

Where:

- a) N_LOC_REF is the most recently received value of the position counter;
- b) N_LOC_BALISE is the position counter at the moment a balise contained in an SP referred to in the current JP is passed;
- c) D_Location of the balise is the balise position given in the SP;
- d) D_Antenna is the distance from the antenna to the train front end;
- e) $d(\Delta t)$ is the distance travelled during the estimated time elapsed since the time at which the position counter was determined.

7.10.1.4 In order to supervise any element sent by the ETCS-OB, the ATO-OB shall determine the front end of the train as follows:

$$\text{Estimated front end} = N_LOC_REF + Q_{rc} * (D_Antenna + d(\Delta t))$$

$$\text{Max safe front end} = N_LOC_REF + Q_{rc} * (D_Antenna + L_UNCERTAINTY_UNDERREADING + d(\Delta t))$$

$$\text{Min safe front end} = N_LOC_REF + Q_{rc} * (D_Antenna - L_UNCERTAINTY_OVERREADING + d(\Delta t))$$

Where:

- a) N_LOC_REF is the most recently received value of the position counter;
- b) D_Antenna is the distance from the antenna to the train front end;
- c) L UNCERTAINTY UNDERREADING is the under-reading amount of the confidence interval to the train position from the SOLR;
- d) L UNCERTAINTY OVERREADING is the over-reading amount of the confidence interval to the train position from the SOLR;
- e) d (Δt) is the distance travelled during the estimated time elapsed since the time at which the position counter was determined;
- f) Q_{rc} is the factor to indicate whether a movement in the direction of the train orientation corresponds to an increase (Q_{rc} = 1) or a decrease (Q_{rc} = -1) of the raw counter.

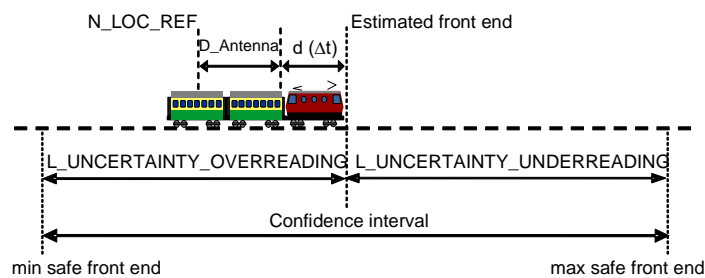

Figure 5 Train position to supervise ETCS-OB elements

7.10.1.5 The ATO-OB shall determine the estimated rear end position of the train as the estimated front end position minus the length of the train provided by the ETCS-OB.

7.10.1.6 The ATO-OB shall determine the minimum safe rear end position of the train as the minimum safe front end position minus the length of the train provided by the ETCS-OB.

- 7.10.1.7 When locating the train for the first time in a JP, the ATO-OB has to check which of the 3 balise information received from the ETCS-OB are contained in an SP referred to in the current JP:
- a) If at least two different balises out of the three are contained in an SP referred to in the current JP, the ATO-OB shall determine the train position within an SP from:
 - 1) The travelling direction given in the JP;
 - 2) The information of those balises.
 - b) If only the reference balise of the SOLR is contained in an SP referred to in the current JP, the ATO-OB shall determine the train position within an SP from:
 - 1) The travelling direction given in the JP;
 - 2) The orientation of the train in relation to the direction of the SOLR;
 - 3) The position of the front end of the train in relation to the SOLR (nominal or reverse side of the SOLR);
 - 4) The information about the SOLR.
 - c) If none of the previous conditions is fulfilled, the ATO-OB will not be able to locate the train within an SP referred to in the current JP using the received balise information.
- 7.10.1.8 **Note:** The ATO-OB may be directly interfaced to odometer sensors (application specific).

7.11 Driving Advisory System (DAS)

- 7.11.1.1 The ATO-OB shall compute DAS trajectories defined by a “Target Advice Speed” or a “Coasting advice” and a “distance to next advice change” in order to follow the ATO Operational Speed Profile defined from TTSM, ATSM and SSEM.
- 7.11.1.2 **Note:** The way to establish DAS trajectories to follow the ATO Operational Speed Profile is supplier specific.

7.12 Perform ATO-OB self-tests

- 7.12.1.1 The ATO-OB system shall execute automatically (without requiring additional action by staff) self-tests procedures (if any) to determine whether the equipment is capable of operating and is fit for service.
- 7.12.1.2 The ATO-OB shall make sure that performed self-tests (if any) do not have any impact on connected systems (e.g. ETCS-OB, Rolling Stock).
- 7.12.1.3 **Note:** The execution or not of any self-test is supplier specific.
- 7.12.1.4 When self-tests fail, the ATO-OB shall go to Failure State.

7.13 ATO-OB Data acquisition

7.13.1 ETCS Data

7.13.1.1 The ETCS data transmitted by the ETCS-OB to the ATO-OB shall include a subset of the ETCS Train Data (defined in [Ref 5]), as listed below:

- a) Train category(ies);
- b) Train length;
- c) Traction / brake parameters:
 - 1) Nominal rotating mass (if available);
 - 2) Brake Percentage (if captured as ETCS Train Data and the conversion model is applicable);
 - 3) Brake Position.
- d) Maximum train speed;
- e) Axle load category.

7.13.1.2 The ETCS data transmitted by the ETCS-OB to the ATO-OB shall include an “Index for trains on which the braking models are captured as Train Data”. This index refers to the set of full service braking models preconfigured in the ETCS-OB, which are currently applicable according to the capture of the ETCS Train Data.

7.13.1.3 Each value of the “Index for trains on which the braking models are captured as Train Data” refers to a set of preconfigured full service braking models.

7.13.1.4 Each preconfigured full service braking model within a set is defined by a different combination of use of regenerative brake and eddy current brake.

7.13.1.5 Both ATO-OB and ETCS-OB shall coherently store:

- a) The sets of full service braking models with their corresponding indexes, for trains on which the braking models are captured as Train Data and;
- b) Up to six normal service braking models together with their corresponding brake position and pivot values,

following the rules defined in [Ref 5] §3.13.2.2.3.1.

7.13.1.6 **Note:** Extra data for the ATO-OB are handled in the Specific ATO Data Entry procedure (see §7.13.2).

7.13.1.7 The ETCS data transmitted by the ETCS-OB to the ATO-OB shall include a subset of ETCS Additional Data (defined in [Ref 5]) as listed below:

- a) Driver ID;
- b) TRN;
- c) ETCS identity.

7.13.1.8 The ETCS data transmitted by the ETCS-OB to the ATO-OB shall include, for each antenna installed on-board, the distance from the antenna to the train front end used by the ETCS-OB to determine the train front end position.

7.13.1.9 **Note:** ETCS Train Data could be changed and validated from sources different from the driver if acquired from ETCS-OB external sources.

7.13.2 Specific ATO Data Entry

7.13.2.1 Definitions

7.13.2.2 The “Specific ATO Data” are the data that need to be requested to the driver.

7.13.2.3 All “Specific ATO Data” used by the ATO-OB are assigned a unique Data Identifier.

7.13.2.4 The process to deliver those “Specific ATO Data” to the ATO-OB is called “Specific ATO Data Entry”.

7.13.2.5 **Note:** Specific ATO Data Entry is possible at start-up and later on during mission through the Train Data Entry procedure.

7.13.2.6 Responsibilities

7.13.2.7 The ETCS-OB is responsible for the dialogue with the driver during the Specific ATO Data Entry/Validation process, for checking the technical range checks (if configured on-board) and for the transmission of the Specific ATO Data after the driver’s validation.

7.13.2.8 The ATO-OB is responsible for checking the content (e.g. range, spares, internal dependency of parameters) of the data. The ATO-OB can be exempted of technical range checks if those are configured in the ETCS-OB.

7.13.2.9 General requirements

7.13.2.10 The ETCS-OB shall offer the possibility to the driver to skip the Specific ATO Data Entry.

7.13.2.11 If Specific ATO Data becomes invalid, the ATO-OB may request the data from the ETCS-OB by sending the “Specific ATO Data Need”.

7.13.2.12 Specific ATO Data can be or become invalid, because:

- a) The Specific ATO Data Entry procedure has not yet been performed or has been aborted, or
- b) The driver has skipped the Specific ATO Data Entry for the ATO-OB before the ATO-OB has sent the “End of Specific ATO Data Entry” to the ETCS-OB, or
- c) The ATO-OB detects that the validity of the Specific ATO Data may have been affected.

7.13.2.13 **Note:** The conditions to detect that the validity of the Specific ATO Data may have been affected are supplier specific, e.g. the ETCS Train Data has changed from sources

different from the driver and this change impacts the validity status of the Specific ATO Data.

- 7.13.2.14 When it receives the “Specific ATO Data Need” while in FS, AD, LS, SR, OS, UN, TR, PT and SN modes, the ETCS-OB shall inform the driver that the ATO-OB needs data.
- 7.13.2.15 The ETCS-OB shall delete this information to the driver when the driver initiates the Train Data entry procedure or when the ATO-OB is considered as failed.
- 7.13.2.16 The ATO-OB requests its Specific ATO Data with a “Specific ATO Data Entry request” which shall include for each Specific ATO Data, the following information: the label, optionally a default value, and optionally values for a dedicated keyboard.
- 7.13.2.17 **Note:** Unless values for a dedicated keyboard are provided or the type of keyboard is configured on-board, an alphanumeric keyboard will by default be used (see [Ref 11]).
- 7.13.2.18 It shall be possible to configure in the ETCS-OB the following parameters for each Specific ATO Data Identifier not using a dedicated keyboard:
- The type of keyboard amongst numeric, enhanced numeric and alphanumeric;
 - If the type of keyboard is numeric or enhanced numeric, whether leading zeros have to be kept and sent to the ATO;
 - The allowed minimum and maximum value, that shall be used by the ETCS-OB with a technical range check.
- 7.13.2.19 By analogy to the modification/revalidation of ETCS Train data, the [Ref 5] requirements §3.14.1.7.3, §3.18.3.3.1 regarding the brake command/release when a movement is detected while modifying or revalidating the Train Data in normal operation after the start of mission shall also apply for the Specific ATO data modification/revalidation.
- 7.13.2.20 **Specific ATO Data Entry procedure**
- 7.13.2.21 As soon as the ETCS Train Data is validated by the driver, the ETCS-OB shall indicate to the ATO-OB the beginning of its Specific ATO Data Entry procedure by sending the START flag.
- 7.13.2.22 The ETCS Train Data shall be sent immediately after the START flag.
- 7.13.2.23 While a Specific ATO Data Entry is ongoing, the ETCS-OB shall indicate to the ATO-OB the end of its Specific ATO Data Entry procedure by sending the STOP flag when one of the following conditions is fulfilled:
- After having received the “End of Specific ATO Data Entry” from the ATO-OB;
 - At expiration of the timeout specified in §7.13.2.30 for the ATO-OB;
 - When the Train Data Entry procedure is aborted by the ETCS-OB for reasons not related to the ATO-OB interface;
 - The Specific ATO Data Entry for the ATO-OB has been skipped by the driver, see §7.13.2.10.

- 7.13.2.24 **Note:** Reasons leading to the abortion of the Train Data entry procedure and not related to the ATO-OB interface can be e.g. the cab deactivation, the driver aborting the Train Data entry procedure...
- 7.13.2.25 **Note:** ETCS Train Data is also sent without the START and STOP flags outside a Train Data entry procedure, see §10.1.8.1.
- 7.13.2.26 Once the ATO-OB has received the ETCS Train Data while its Specific ATO Data Entry is ongoing:
- a) If the ATO-OB requires Specific ATO Data, the ATO-OB shall send a “Specific ATO Data Entry request” information to the ETCS-OB;
 - b) If the ATO-OB doesn’t require Specific ATO Data, the ATO-OB shall send an “End of Specific ATO Data Entry” information to the ETCS-OB.
- 7.13.2.27 When it receives the Specific ATO Data Entry request, the ETCS-OB shall perform the Specific ATO Data Entry/Validation exchanges with the driver.
- 7.13.2.28 Once the Specific ATO Data for an ATO-OB has been validated by the driver, the ETCS-OB shall send the “Specific ATO Data” to this ATO-OB.
- 7.13.2.29 When the ATO-OB receives the Specific ATO Data, it checks the data according to its criteria. Depending on the check result:
- a) The ATO-OB shall send an “End of Specific ATO Data Entry” if the checks are OK and the ATO-OB has all the requested data;
 - b) The ATO-OB shall send again Specific ATO Data Entry request.
- 7.13.2.30 The ETCS-OB shall supervise a timeout of 10 seconds (TrainDataEntry_ATO_Response_Timeout):
- a) From sending the ETCS Train Data by the ETCS-OB while the Specific ATO Data Entry procedure is running until the reception of a Specific ATO Data Entry request or the “End of Specific ATO Data Entry” from the ATO-OB; and
 - b) From each sending Specific ATO Data by the ETCS-OB until the reception of a Specific ATO Data Entry request or the “End of Specific ATO Data Entry” from the ATO-OB.
- 7.13.2.31 If the “TrainDataEntry_ATO_Response_Timeout” is triggered, the ETCS-OB shall apply the same reaction as specified in the clause 10.2.2.8.

7.13.2.32 Sequence diagrams for the Specific ATO Data Entry

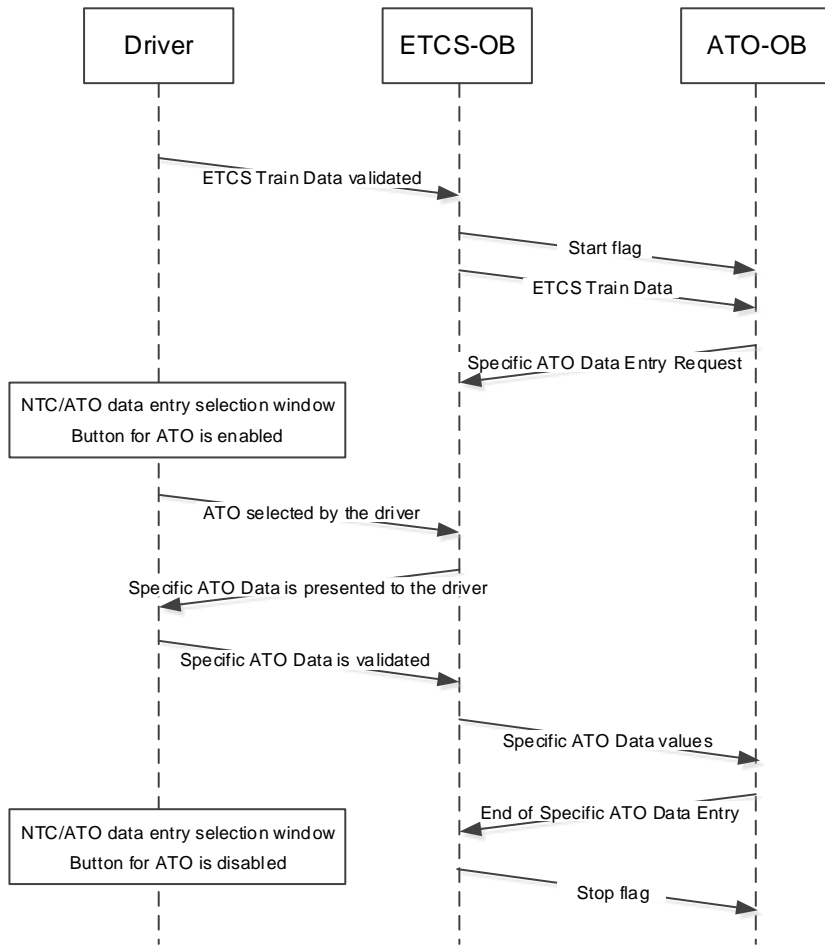

Figure 6 Specific ATO Data Entry performed

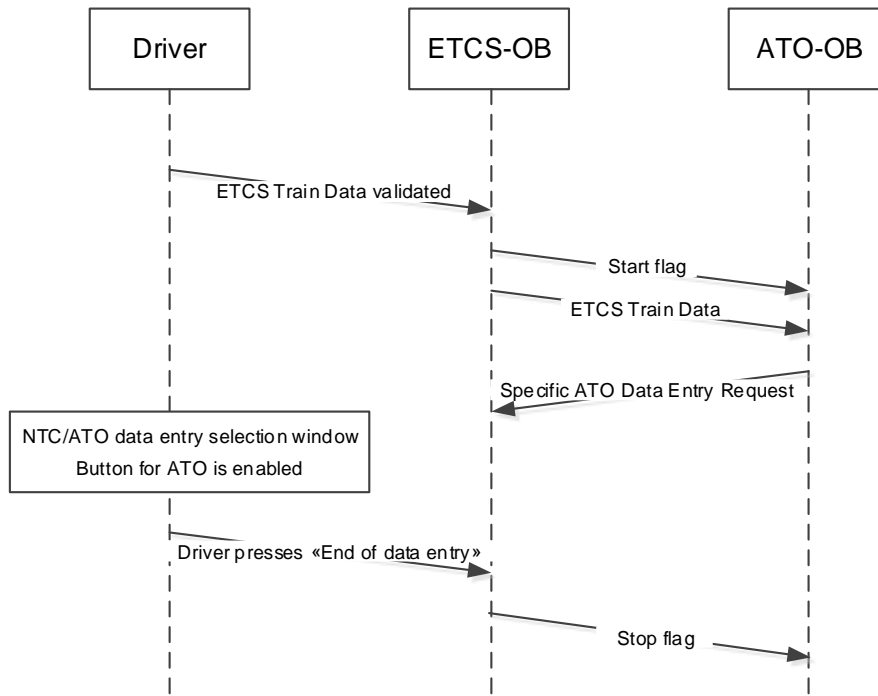

Figure 7 Specific ATO Data Entry skipped

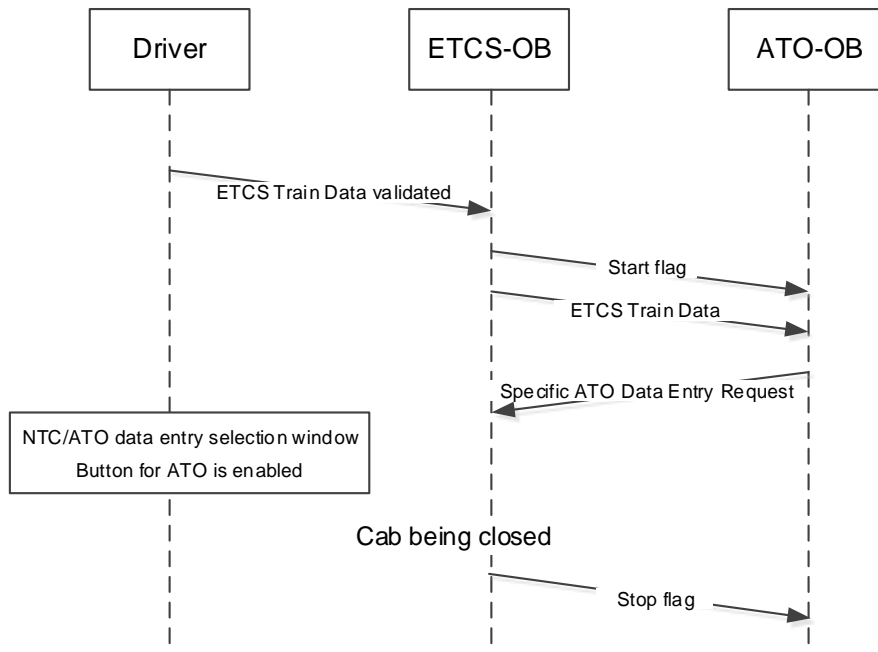

Figure 8 Specific ATO Data Entry aborted

7.13.3 Specific ATO Data View

7.13.3.1 This procedure shall allow the driver to view the Specific ATO Data View values currently known by the ATO-OB.

ERA * UNISIG * EEIG ERTMS USERS GROUP

- 7.13.3.2 When the Data View procedure is triggered, the ETCS-OB shall send to the ATO-OB a Request for Specific ATO Data View values.
- 7.13.3.3 Once the ATO-OB has received the ETCS Request for Specific ATO Data View values:
- a) If the ATO-OB has “Specific ATO Data View values” available, the ATO-OB shall send the corresponding “Specific ATO Data View values” (labels and corresponding values) to the ETCS-OB.
 - b) If the ATO-OB has no “Specific ATO Data View values” available, the ATO-OB shall send a “No Specific ATO Data View values” to the ETCS-OB.
- 7.13.3.4 When it receives the “Specific ATO Data View values”, the ETCS-OB shall present them to the driver.
- 7.13.3.5 The ETCS-OB shall supervise a timeout of 10 seconds (TrainDataView_ATO_Response_Timeout) from sending the Request for Specific ATO Data View values until the reception of “Specific ATO Data View values” or the “No Specific ATO Data View values” information from the ATO-OB.

7.13.3.6 If the “TrainDataView_ATO_Response_Timeout” is triggered, the ETCS-OB shall:

- a) Display the “ATO Failure” indication for a duration of 30 seconds;
- b) Produce a warning sound for a duration of 5 seconds;
- c) Send no packets to the ATO-OB for 30 seconds.

7.13.4 Limitations related to Specific ATO Data Entry/Data View

7.13.4.1 The number of Data Identifiers within one “Specific ATO Data Entry request” shall be limited to 15 Data Identifiers.

7.13.4.2 The number of Data Identifiers within one “Specific ATO Data values” shall be limited to 15 Data Identifiers.

7.13.4.3 The number of Data Identifiers within one “Specific ATO Data View values” shall be limited to 15 Data Identifiers.

7.13.4.4 The maximum number of characters (coded in UTF-8 by 1 or 2 bytes) shall be:

- a) 20 characters for data labels in “Specific ATO Data Entry request” and “Specific ATO Data View values”;
- b) 10 characters for data values in “Specific ATO Data Entry request” and “Specific ATO Data values”;
- c) 10 characters for data view values in “Specific ATO Data View values”.

8. DRIVER MACHINE INTERFACE

8.1 Available Inputs from the driver

- 8.1.1.1 ATO Engage: Used by the driver to request the start of automatic driving (departure of the train or engagement on the move).
- 8.1.1.2 The “ATO Engage” input is considered as enabled by the ETCS-OB when the “ATO ready for engagement” is displayed (see §8.2.1).
- 8.1.1.3 **Note:** When the driver selects “ATO Engage”, if it is not in AD Mode, the ETCS-OB will change to AD Mode if the ETCS-OB applicable conditions for ATO Operational are fulfilled (see §9.1.1.2).
- 8.1.1.4 ATO Disengage: Used by the driver to disengage ATO while the ATO-OB is engaged.
- 8.1.1.5 The “ATO Disengage” input is considered as enabled by the ETCS-OB when the "ATO engaged" or when the “ATO Disengaging” indication is displayed (see §8.2.1).
- 8.1.1.6 **Note:** When the driver selects “ATO Disengage”, the ETCS-OB will change from AD Mode to the applicable ETCS Mode according to the ETCS mode transition table as defined in [Ref 5] §4.6.
- 8.1.1.7 Skip Stopping Point Request/Revocation: Used by the driver to request a Stopping Point skip or to revoke a Stopping Point skip previously requested by himself/herself.
- 8.1.1.8 The “Skip Stopping Point Request” input is considered as enabled by the ETCS-OB while the “Skip Stopping Point Inactive” indication is displayed.
- 8.1.1.9 The “Skip Stopping Point Revocation” input is considered as enabled by the ETCS-OB while the “Skip Stopping Point requested by the driver” indication is displayed.

8.2 Information to be displayed to the driver

8.2.1 ATO Status

- 8.2.1.1 While the ATO-OB is in CO, NA or AV State, the ATO-OB shall request the ETCS-OB to display the “ATO Selected” indication.
- 8.2.1.2 While the ATO-OB is in RE State, the ATO-OB shall request the ETCS-OB to display the “ATO Ready for Engagement” indication.
- 8.2.1.3 While the ATO-OB is in EG State, the ATO-OB shall request the ETCS-OB to display the “ATO Engaged” indication.

- 8.2.1.4 While the ATO-OB is in DE State, the ATO-OB shall request the ETCS-OB to display the “ATO Disengaging” indication.
- 8.2.1.5 When it enters in FA State, the ATO-OB should request where possible the ETCS-OB to display the “ATO Failure” indication until the ATO-OB is not in FA State.
- 8.2.1.6 While it displays the “ATO Failure” indication, the ETCS-OB shall display no other ATO related indication.

8.2.2 Stopping accuracy

- 8.2.2.1 When a train comes to a stop and a Stopping Point is considered as reached, the ATO-OB shall request the ETCS-OB to display an indication indicating if (taking into account the Timing Point alignment required in the JP):
 - a) An accurate stop has been achieved or;
 - b) The train has undershot the stopping window or;
 - c) The train has overshot the stopping window.
- 8.2.2.2 While the train is moving, the ATO-OB shall stop requesting the ETCS-OB to display the stopping accuracy indication.

8.2.3 Dwell time

- 8.2.3.1 When a train comes to a stop at a Stopping Point within the stopping window (taking into account the TP alignment required in the JP), the ATO-OB shall request the ETCS-OB to display the remaining dwell time.
- 8.2.3.2 While the train is stopped at a Stopping Point within the stopping window (taking into account the TP alignment required in the JP) and the ATO-TS requests the train to be held at that Stopping Point (see §7.4.1.1), the ATO-OB shall request the ETCS-OB to display the “Train Hold” indication.
 - 8.2.3.2.1 While the computed dwell time value is equal to or higher than 100 minutes, the ATO-OB shall request the ETCS-OB to display the “Train Hold” indication.
- 8.2.3.3 While the train is moving, the ATO-OB shall stop requesting the ETCS-OB to display the dwell time or the “Train Hold” indication.

8.2.4 Door information

8.2.4.1 When a train comes to a stop at Stopping Point and the train is within the stopping window (taking into account the TP alignment required in the JP), the ATO-OB shall request the ETCS-OB to display either for Manual Door Opening (i.e. when no automatic door opening request has been sent to the train door management system):

- a) "Request driver to open doors on both sides" indication or;
- b) "Request driver to open right doors" indication or;
- c) "Request driver to open left doors" indication,

or for Automatic Door Opening (i.e. when an automatic door opening request has been sent to the train door management system):

- a) "Doors are open" indication.

8.2.4.2 **Note:** For Automatic Door Opening, the command to open the doors is sent when the ATO-OB expects the train to stop within the stopping window of a Stopping Point and the train is at standstill, but the indication "Doors are open" is not displayed until the train comes to a stop.

8.2.4.3 For Manual Door Opening (i.e. when no automatic door opening request has been sent to the train door management system), the ATO-OB shall request the ETCS-OB to display the "Doors are open" indication when doors are no longer closed and locked.

8.2.4.4 When the remaining dwell time is equal to the time to close the doors and the doors are not closed and locked, the ATO-OB shall request the ETCS-OB to display either for Manual Door Closing (i.e. when no automatic door closing request has been sent to the train door management system):

- a) the "Request driver to close doors" indication,

or for Automatic Door Closing (i.e. when an automatic door closing request has been sent to the train door management system):

- b) the "Doors are being closed by ATO" indication.

8.2.4.5 When doors are closed and locked, the ATO-OB shall request the ETCS-OB to display the "Doors are closed" indication.

8.2.3.1 While the train is moving, the ATO-OB shall stop requesting the ETCS-OB to display any door indication.

8.2.4.6 When the start condition is triggered for any door indication, this indication shall replace any previously displayed door indication.

8.2.5 Skip Stopping Point status

8.2.5.1 When the ATO-OB receives a request to skip the next Stopping Point coming from the driver, the ATO-OB shall request the ETCS-OB to display the "Skip Stopping Point requested by the driver" indication until the request is deleted (see 7.3.1.7).

8.2.5.2 When the ATO-OB receives a request to skip the next Stopping Point coming from the ATO-TS, the ATO-OB shall request the ETCS-OB to display the “Skip Stopping Point requested by the ATO-TS” indication until the “Stopping Point to be skipped” is passed or the request is revoked by ATO-TS.

8.2.5.3 While the next Stopping Point is not to be skipped and the doors are closed and locked, the ATO-OB shall request the ETCS-OB to display the “Skip Stopping Point Inactive” indication until the train has stopped at a Stopping Point considered as reached.

8.2.6 Stopping Points distance

8.2.6.1 While the following conditions are fulfilled:

- a) The Operational Conditions except “The train is not located within an ATO Inhibition Zone” are fulfilled (see §9.1.1) and,
- b) The train is not located within a DAS Inhibition Zone,

the ATO-OB shall request the ETCS-OB to display the distances from the train (taking into account the TP alignment required in the JP) to the Stopping Points or Stopping Points to be skipped.

8.2.6.2 Before a Stopping Point is considered as reached or passed, the ATO-OB shall request the ETCS-OB to display a null distance in case its Stopping Point distance becomes negative (e.g. in case of overshoot).

8.2.6.3 Once a Stopping Point (including a Stopping Point to be skipped) is considered as reached or passed the ATO-OB shall no longer request the ETCS-OB to display the Stopping Point distance for that Stopping Point.

8.2.7 Stopping Point name and estimated arrival time

8.2.7.1 While the following conditions are fulfilled:

- a) The Operational Conditions except “The train is not located within an ATO Inhibition Zone” are fulfilled (see §9.1.1);
- b) The train is not located within a DAS Inhibition Zone,

the ATO-OB shall request the ETCS-OB to display the name and the estimated arrival time at the next Stopping Point or Stopping Point to be skipped.

8.2.7.2 Once a Stopping Point (including a Stopping Point to be skipped) is considered as reached or passed the ATO-OB shall no longer request the ETCS-OB to display the Stopping Point name and estimated arrival time for that Stopping Point.

8.2.8 DAS information

8.2.8.1 The ATO-OB shall request the ETCS-OB to display the following information:

- a) “Target Advice Speed” or the “Coasting advice” indication;

b) "Distance to next advice change",

while the following conditions are fulfilled:

- a) The ETCS-OB is not in AD Mode;
- b) The Operational Conditions except "The train is not located within an ATO Inhibition Zone" are fulfilled (see §9.1.1);
- c) The train is not located within a DAS Inhibition Zone;
- d) The next "Target Advice Speed" is not zero.

8.2.9 Driver warning sounds

8.2.9.1 If the TBL is in traction position when the ATO-OB enters EG State and the TBL does not leave the traction position within 5 seconds, the ATO-OB shall request the ETCS-OB to produce a warning sound until the TBL is set to neutral position.

8.2.9.2 If the TBL is moved to traction position while the ATO-OB is in EG State, the ATO-OB shall request the ETCS-OB to produce a warning sound until the TBL is set to neutral position.

8.2.9.3 While the ATO-OB is in DE State, the ATO-OB shall request the ETCS-OB to produce a warning sound.

8.2.9.4 When the ATO-OB enters FA State (see §9.9), the ATO-OB should try to request the ETCS-OB to produce a warning sound for a duration of 5 seconds.

8.2.10 ATO DMI inputs versus State Table

8.2.10.1 X = This means that it shall be possible for the driver to enter this information when ATO-OB is in the state indicated in the column.

Empty case = This means that it shall not be possible for the driver to enter this information when ATO-OB is in the state indicated in the column.

NApp = Not Applicable: This concerns the FA State in which the driver inputs cannot be determined.

Input information	Related SRS §	NP	CO	NA	AV	RE	EG	DE	FA
ATO Engage	8.1.1.1					X			NApp
ATO Disengage	8.1.1.4						X	X	NApp
Skip Stopping Point Request	8.1.1.7, 7.3.1.5				X	X	X	X	NApp
Skip Stopping Point Revocation	8.1.1.7, 7.3.1.6				X	X	X	X	NApp

Table 4 ATO DMI inputs versus State Table

8.2.11 ATO DMI outputs versus State Table

8.2.11.1 X = This means that the output information shall be sent to the ETCS-OB when the ATO-OB is in the state indicated in the column.

Empty case = This means that the output information shall not be send to the ETCS-OB when the ATO-OB is in the state indicated in the column.

NApp = Not Applicable: This concerns the FA State in which the output information cannot be determined.

Output information	Related SRS §	NP	CO	NA	AV	RE	EG	DE	FA
ATO status	8.2.1		X	X	X	X	X	X	X
Dwell time	8.2.3			X ¹	X	X			NApp
Stopping accuracy	8.2.2			X ¹	X	X			NApp
Door information	8.2.4			X ¹	X	X			NApp
Skip Stopping Point status	8.2.5				X	X	X	X	NApp
Stopping Points distance	8.2.6				X	X	X	X	NApp
Stopping Point name and estimated arrival time	8.2.7				X	X	X	X	NApp
Target Advice Speed or Coasting advice	8.2.8			X ²	X ²	X ²			NApp
Distance to next advice change	8.2.8			X ²	X ²	X ²			NApp
Driver warning sounds	8.2.9						X	X	NApp

¹ When the JP and SP information required is available.

² When clause §8.2.8.1 is fulfilled.

Table 5 ATO DMI outputs versus State table

9. ATO OPERATION STATES

9.1 Main concepts

9.1.1 ATO Operational Conditions

9.1.1.1 The ATO-OB System shall be ready for ATO operation (i.e. ATO Operational) when all the following conditions are satisfied:

- a) The ETCS-OB applicable conditions for ATO Operational are fulfilled (See §9.1.1.2);
- b) There is no Emergency Brake application by another system or the driver;
- c) The TP “End of Journey” of the current journey has not been reached (Stopping Point) or passed (Passing Point or Stopping Point to be skipped) ;
- d) The last TP of the journey has not been passed;
- e) All referenced SPs up to the targeted TP are available on-board;
- f) Data inconsistency affecting the next TP is not detected (see §7.8);
- g) The train is located in an SP included in the current JP;
- h) The train is not located within an ATO Inhibition Zone;
- i) The ETCS Data and ATO Specific Data are valid.

9.1.1.2 The ETCS-OB applicable conditions for ATO Operational are:

- a) The ETCS-OB is in AD Mode or FS Mode and conditions for displaying “ENTERING FS” no longer exist (see [Ref 5] §4.4.9.1.4);
- b) The ETCS-OB is not commanding the Emergency Brake or Full Service Brake.

9.1.2 ATO Engagement Conditions

9.1.2.1 The following conditions shall be fulfilled in order to be able to engage the ATO-OB:

- a) Direction controller is in forward position (only applicable when the direction controller information is available);
- b) While the train is stopped at a platform area, the MA shall be such that the train is able to leave the platform completely based on estimated rear end;
- c) While the train is stopped outside a platform area, the MA allows the train to move (the minimum distance to allow proceeding is train specific);
- d) When the ATO-OB is not engaged and the train is approaching a Stopping Point, the remaining distance is sufficient for the ATO-OB to stop the train (the minimum distance to stop the train is train specific);
- e) Train doors are closed and locked;
- f) The dwell time is elapsed (if any);
- g) Train applicable conditions for operating ATO are fulfilled;
- h) The TBL is not in brake position;

i) While the train is stopped the TBL is not in traction position.

9.1.2.1.1 **Note:** The condition “Train doors are closed and locked” only applies to passenger trains.

9.1.2.2 If the train is not able to provide train applicable conditions (configuration parameter), ATO-OB shall consider the train applicable conditions are always fulfilled.

9.2 No Power (NP)

9.2.1.1 The ATO-OB shall remain in NP State when it is switched off.

9.2.1.2 When it is in NP State, the ATO-OB has no responsibility for train operation.

9.3 ATO Configuration (CO)

9.3.1.1 The CO State is the default State entered by the ATO-OB after the ATO-OB is switched on.

9.3.1.2 The ATO-OB shall remain in CO State until it has received the required ETCS Data and Specific ATO Data.

9.3.1.3 When the ATO-OB enters CO State, the ATO-OB shall send a “Specific ATO Data Need” information to the ETCS-OB indicating whether it needs or not Specific ATO Data.

9.3.1.4 When it is in CO State, the ATO-OB has no responsibility for train operation.

9.4 ATO Not Available (NA)

9.4.1.1 When it is in NA State, the ATO-OB is waiting for the ATO Operational Conditions (see §9.1.1) to be fulfilled.

9.4.1.2 When it is in NA State, the ATO-OB has no responsibility for train movement.

9.5 ATO Available (AV)

9.5.1.1 When it is in AV State, the ATO-OB is ready for operation and it is waiting for the ATO Engagement Conditions to be fulfilled (see §9.1.2).

9.5.1.2 When it is in AV State, the ATO-OB has no responsibility for train movement.

9.6 ATO Ready (RE)

9.6.1.1 When it is in RE State, the ATO-OB is ready to control train operation as all technical and operational conditions for engagement are fulfilled but the ATO-OB is waiting for driver action to start automatic driving.

- 9.6.1.2 When the conditions for engagement are fulfilled, the driver has the responsibility of starting automatic driving by selecting “ATO Engage”.
- 9.6.1.3 When it is in RE State, the ATO-OB is not yet responsible for train movement (still waiting for the action by the driver to start automatic driving).
- 9.6.1.4 **Note:** The request to start automatic driving may be done when the train is either stopped or moving.

9.7 ATO Engaged (EG)

- 9.7.1.1 When it is in EG State, the ATO-OB is responsible for driving the train controlling brake and traction according to the computed ATO Operational Speed Profile.

9.8 ATO Disengaging (DE)

- 9.8.1.1 The ATO-OB shall transition to DE State, if any of the ATO Operational Conditions but the ETCS related ones is lost while the ATO-OB is in EG State.
- 9.8.1.2 During the first 5 seconds after the ATO-OB has transitioned to DE State, the ATO-OB shall continue to follow the last computed ATO Operational Speed Profile with the limitation of not requesting traction.
- 9.8.1.3 If the ATO-OB recovers the ATO Operational Conditions within the first 5 seconds after the ATO-OB has transitioned to DE State, the ATO-OB shall transition to EG State.
- 9.8.1.4 If the ATO-OB does not recover the ATO Operational Conditions within the first 5 seconds after the ATO-OB has transitioned to DE State, the ATO-OB shall apply the Full Service Brake (if it is not already applied).
- 9.8.1.5 **Note:** The ATO Disengaging scenario is described in section §9.10.3.

9.9 ATO Failure (FA)

- 9.9.1.1 The ATO-OB shall enter the FA State in case of a fault which does not allow performing ATO functions.
- 9.9.1.2 **Note:** In FA State, the driver has the responsibility to execute the operational procedures defined by supplier and Railway Undertakings.
- 9.9.1.3 Transitions to FA State shall be reported by the ATO-OB to the ATO-TS and the driver (if it is still possible) and recorded on-board.

9.10 Transitions between States

9.10.1 Introduction

9.10.1.1 This section §9.10 defines the different scenarios and the transitions between ATO-OB States including the transition conditions.

9.10.1.2 **Note:** The sections from §9.10.1 to §9.10.5 are not requirements but just descriptive text.

9.10.2 Nominal scenario

9.10.2.1 The Figure 9 Nominal scenario shows the nominal ATO operation scenario.

9.10.2.2 The nominal scenario is based on the following steps:

- 1) The ATO-OB is powered on.
The ATO-OB transitions from NP to CO State. The “ATO Selected” indication is displayed.
- 2) ETCS data entry process (including ATO Specific Data Entry) is completed and the ATO-OB receives the required data.
The ATO-OB transitions from CO to NA State. The “ATO Selected” indication is displayed.
- 3) When the ATO Operational Conditions are fulfilled (see §9.1.1), the ATO-OB transitions from NA to AV State. The “ATO Selected” indication is still displayed.
- 4) When all the ATO Engagement Conditions are fulfilled (see §9.1.2), the ATO-OB transitions from AV to RE State and the “ATO Ready for Engagement” indication is displayed to the driver.
- 5) The driver selects “ATO Engage”, the ETCS-OB changes to AD Mode.
The ATO-OB transitions from RE to EG State. The “ATO Engaged” indication is displayed to the driver and the ATO-OB starts driving the train automatically
- 6) The ATO-OB drives the train. When the train stops, the ATO-OB requests the “Train Holding Brake” application and the “ATO Selected” indication is again displayed to the driver.
The ATO-OB transitions from EG to AV State. The train is stationary waiting until the ATO Engagement Conditions are fulfilled again.
- 7) Return to step 4) and repeat the sequence until the end of the journey.

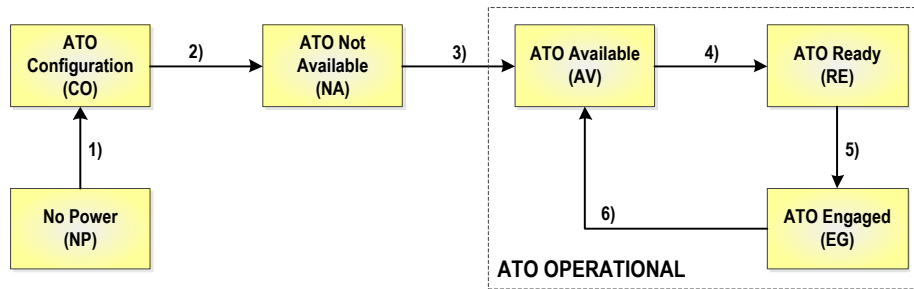

Figure 9 Nominal scenario

9.10.3 Alternative scenario: Losing ATO Operational Conditions

9.10.3.1 Precondition: the train is running with the ATO-OB in EG State and loses ATO Operational Conditions (see §9.1.1).

9.10.3.2 If the ATO-OB loses any ATO Operational Condition (see §9.1.1) except “The ETCS-OB applicable conditions for ATO Operational are fulfilled” (see §9.1.1.1 a)), the scenario is based on the following steps:

- 1) The “ATO Disengaging” indication is displayed to the driver;
 - 2) The ATO-OB transitions from EG to DE State with the following consequences:
 - a) During the first 5 seconds after the ATO-OB has transitioned to DE State, the ATO-OB continues to follow the last computed ATO Operational Speed Profile with the limitation of not requesting traction (§9.8.1.2).
 - b) If the driver applies the brake using the TBL or selects “ATO Disengage” before 5 seconds, the ATO-OB transitions from DE to NA State and the ETCS-OB leaves AD Mode;
 - c) If ATO-OB recovers ATO Operational Conditions before 5 seconds (no selection of “ATO Engage” is required in this situation), the ATO-OB transitions from DE to EG State and continues to drive the train automatically;
 - d) If the driver does not react and the ATO Operational Conditions are not recovered after 5 seconds, the ATO-OB remains in DE State and applies the Full Service Brake (if not already applied):
 - i. If the driver brakes using the TBL or selects “ATO Disengage” at any time while the ATO-OB is braking, the ATO-OB releases its Service Brake command and transitions from DE to NA State.
 - ii. When the train is stopped, the ATO-OB transitions from DE to NA State and the ETCS-OB leaves AD Mode.
- 9.10.3.3 If the ATO-OB loses the ATO Operational Condition “The ETCS-OB applicable conditions for ATO Operational are fulfilled” (see §9.1.1.1 a)), the scenario is based on the following steps:
- 1) The ETCS-OB leaves AD Mode;
 - 2) The “ATO Selected” indication is displayed to the driver;
 - 3) The ATO-OB transitions to NA State.

9.10.4 Alternative scenario: ATO Failure

9.10.4.1 This scenario is based on the following steps:

- 1) The ATO-OB detects a fault that does not allow ATO operation;
- 2) The ATO-OB transitions to FA State;
- 3) The “ATO Failure” indication is displayed to the driver and an audible warning is generated during 5 seconds;
- 4) The driver executes the operational procedures defined by supplier and Railway Undertakings.

9.10.5 Alternative scenario: Driver brakes manually while the train is automatically driven

9.10.5.1 Precondition: The ATO-OB is in EG State.

9.10.5.2 This scenario is based on the following steps:

- 1) The driver manually brakes using the TBL;
- 2) The ATO-OB stops automatic driving. The ATO-OB transitions to AV State;
- 3) The driver continues driving manually until the driver decides to start automatic driving again. Then the driver sets the TBL in neutral or traction position and selects “ATO Engage”. The sequence continues as in the nominal scenario.

9.10.6 Flowchart of ATO-OB State transitions

9.10.6.1 The transitions shall comply with the information given on:

- a) The previous information of the present section §9 (excluding descriptive text of clauses from §9.10.1 to §9.10.5);
- b) The Table 6 Transition table;
- c) The Table 7 Transition conditions table.

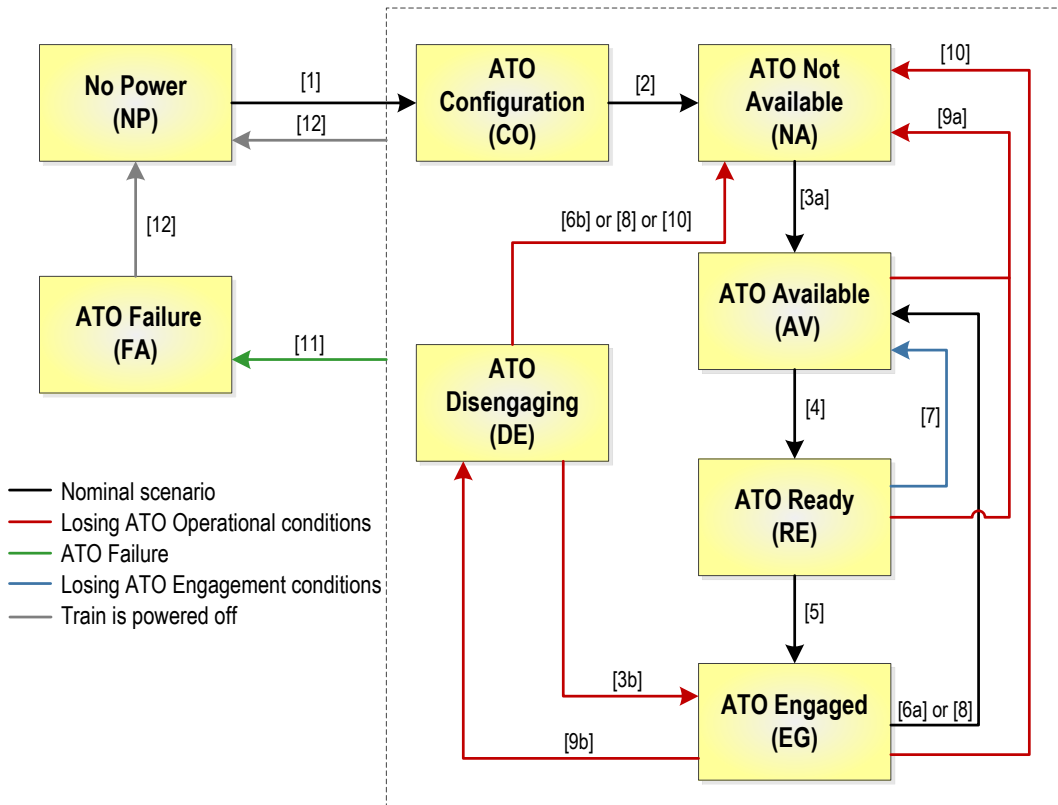

Figure 10 State Transitions

ERA * UNISIG * EEIG ERTMS USERS GROUP

9.10.7 Symbols

9.10.7.1 The indication "4>" means: The condition n°4 must be fulfilled to trigger the transition from the state located in the column to the state that is indicated by the arrow ">".

9.10.7.2 Each transition from a given state receives a priority order (indicated by "-px-", x is the priority order) to avoid a conflict between the different transitions when they occur at the same time (i.e. in the same clock cycle). P1 has a higher priority than P2.

9.10.7.3 "8, 10, 11" means "8 or 10 or 11".

9.10.8 Transition table

NP	<12 -p1-	<12 -p1-	<12 -p1-	<12 -p1-	<12 -p1-	<12 -p1-	<12 -p1-
1> -p1-	CO						
	2> -p3-	NA	<9a -p3-	<9a -p3-	<10 -p3-	<6b, 8, 10 -p3-	
		3a> -p3-	AV	<7 -p4-	<6a,8 -p4-		
			4> -p4-	RE			
				5> -p5-	EG	<3b -p4-	
					9b> -p5-	DE	
	11> -p2-	11> -p2-	11> -p2-	11> -p2-	11> -p2-	11> -p2-	FA

Table 6 Transition table

9.10.8.1 If several consecutive transition conditions are fulfilled at the same time, the ATO-OB State shall transition from the initial state to the final state without performing any action(s) linked to the intermediate state(s).

9.10.9 Transition conditions table

Condition Id	Content of the conditions
[1]	The ATO-OB is powered on.
[2]	The ATO-OB has received the required “ETCS Data” and “Specific ATO Data”.
[3a]	The ATO Operational Conditions are fulfilled (see §9.1.1).
[3b]	(The Train Applicable conditions for operating ATO are fulfilled) AND (The ATO-OB recovers the ATO Operational Conditions (see §9.1.1) within 5 seconds after changing to DE State).
[4]	The ATO Engagement Conditions are fulfilled (see §9.1.2).
[5]	The ATO-OB considers the input “ATO Engage” as selected (see §10.2.8.6, i.e. the driver has selected “ATO Engage” and the ETCS-OB is in AD Mode),
[6a]	(The train stops at a Stopping Point considered as reached) AND (the train is stationary through at least the application of the Train Holding Brake, see §6.2.1.6 to §6.2.1.8).
[6b]	(The train stops) AND (the train is stationary through at least the application of the Train Holding Brake, see §6.2.1.6 to §6.2.1.8).
[7]	The ATO Engagement Conditions are not fulfilled (see §9.1.2).
[8]	The Driver manually brakes using the TBL.
[9a]	The ATO-OB loses any ATO Operational Condition.
[9b]	The Train Applicable conditions for operating ATO are not fulfilled OR ATO-OB loses any ATO Operational Condition (see §9.1.1) except “The ETCS-OB applicable conditions for ATO Operational are fulfilled” (see §9.1.1.1 a).
[10]	The ETCS-OB leaves AD Mode
[11]	The ATO-OB detects a fault which does not allow performing ATO functions (e.g. connection with ETCS-OB is not active while ATO-OB is not in CO State).
[12]	The ATO-OB is powered off.

Table 7 Transition conditions table

9.11 ATO-OB Active Functions Table

9.11.1.1 X = functions shall be active

Empty case = function shall be inactive

O = Optional (function is not required for interoperability, but is not forbidden)

ATO-OB FUNCTIONS	RELATED SRS §	NP	CO	NA	AV	RE	EG	DE	FA
General requirements									
SP version management	10.1.7.25		X	X	X	X	X	X	
ATO Functions									
Compute the ATO Operational Speed Profile	7.1.2, 7.1.3, 7.1.4		O	O	O	O	X	X	
Send traction commands	7.1.5						X		
Send braking commands	7.1.5 6.2.1.6				X	X	X	X	
Send train doors opening/closing requests	7.2.2				X		X		
Compute the dwell time	7.2.3			X ¹	X	X			
Manage changes in Stopping Points in the JP	7.3			X ¹	X	X	X	X	
Hold train at a Stopping Point	7.2.3.3, 7.4			X ¹	X	X			
Manage low adhesion	7.5						X	X	
Time Management	7.6		X	X	X	X	X	X	O
Provide STRs to ATO-TS	7.7		X ¹	X	X	X	X	X	O
Detect data inconsistency	7.8		X ¹	X ¹	X	X	X	X	
ATO System Version Management	7.9			X ¹	X	X	X	X	
ATO-OB Train Position Determination	7.9.4			X ¹	X	X	X	X	
Driver Advisory System (DAS)	7.11		O	X ²	X ²	X ²	O	O	
Perform ATO-OB self-tests	7.12		O	O	O	O	O	O	
ATO-OB Data acquisition	7.13		X	X	X	X	X	X	
ATO-OB States Management Conditions									
Determine ATO-OB State	9.10		X	X	X	X	X	X	X
ATO Communication									
Send and receive information to/from the ETCS-OB	10.2		X	X	X	X	X	X	O

ATO-OB FUNCTIONS	RELATED SRS §	NP	CO	NA	AV	RE	EG	DE	FA
Send and receive messages to/from the ATO-TS ³	10.1		X	X	X	X	X	X	

¹ When the JP and SP information required is available.

² When clause §8.2.8.1 is fulfilled.

³ Excluding function “Provide STRs to ATO-TS”.

Table 8 ATO-OB Active Functions table

9.12 ETCS Mode transition request

9.12.1.1 The ATO-OB shall request the ETCS-OB to be in AD Mode as long as any of the following conditions is fulfilled:

- a) The ATO-OB is in RE, EG or DE State;
- b) The ATO-OB is in AV State, the ETCS-OB is in AD Mode and the TBL is in neutral position.

9.12.1.2 To change from “not requesting AD Mode” to “requesting AD Mode”, the ATO-OB shall first verify that the current ETCS-OB Mode is not AD.

9.12.1.3 **Note:** The ATO-OB needs to verify that the ETCS-OB has left AD Mode before requesting it again to guard against situations where the ATO-OB may become disengaged while the ETCS-OB remains in AD mode. For example, if the ATO-OB transitions to RE State due to a momentary brake request from the TBL and then requests AD Mode again, there is a possibility that the ETCS-OB could miss the “AD Mode Not Requested” information.

9.12.1.4 **Note:** When the ATO-OB stops requesting the ETCS-OB to be AD Mode, the ETCS-OB will change from AD Mode to the applicable ETCS Mode according to the ETCS mode transition table as defined in [Ref 5] §4.6.

10. INTERFACES

10.1 ATO-OB / ATO-TS interface

10.1.1 Introduction

10.1.1.1 **Note:** This section §10.1 gives only the requirements dedicated to the ATO-OB/ATO-TS interface application level. The requirements dedicated to the ATO-OB/ATO-TS transport and security layers are defined in [Ref 8].

10.1.1.2 The ATO-TS/ATO-OB interface shall be interoperable.

10.1.1.3 **Note:** The following packets are sent from the ATO-TS to ATO-OB:

- a) Segment Profiles (SP);
- b) Journey Profiles (JP);
- c) ATO Status Report Acknowledgement (STRAck);
- d) Handshake Acknowledgement (HSAck);
- e) Handshake Reject (HSRej);
- f) Session Termination Request (SESSTermReq).

10.1.1.4 **Note:** The following packets are sent from the ATO-OB to ATO-TS:

- a) Journey Profile Request (JPReq);
- b) Segment Profile Request (SPReq);
- c) Journey Profile Acknowledgement (JPAck);
- d) ATO Status Report (STR);
- e) Handshake Request (HSReq);
- f) Session Termination (SESSTerm).

10.1.2 Conditions for establishing a communication session

10.1.2.1 The ATO-OB shall establish a communication session as soon as all the following conditions are fulfilled:

- a) The Cab is active;
- b) ATO-OB has received:
 - 1) A valid TRN;
 - 2) An ETCS identity;
 - 3) A valid train length;
- c) ETCS-OB is not in NL Mode or in SH Mode.

10.1.2.2 The ATO-OB shall establish a communication session with an ATO-TS identified by an ATO-TS Contact Information.

10.1.2.3 The ATO-TS Contact Information shall be unique and composed of NID_C and NID_ATOTS.

10.1.2.4 **Note:** The value of the preconfigured ATO-TS Contact Information may be modified according to a maintenance procedure which is not harmonised.

10.1.3 Establishing communication sessions

10.1.3.1 The ATO-OB shall have a preconfigured ATO-TS Contact Information corresponding to the ATO-TS to be initially contacted.

10.1.3.2 The ATO-OB shall send an HSReq to the ATO-TS corresponding to the preconfigured ATO-TS Contact Information including the list of ATO system versions that it supports.

10.1.3.3 The ATO-TS shall answer with an HSAck or with an HSRej.

10.1.3.4 If no feedback (HSAck or HSRej) has been received after ATO-OB has sent an HSReq to ATO-TS and ATO-OB repeats the HSReq, this repetition shall be done 30 seconds later, at the earliest.

10.1.3.5 When ATO-OB receives an HSAck, the communication session shall be considered established.

10.1.3.6 The HSAck sent by the ATO-TS to ATO-OB shall include:

- a) ATO-TS Identifier;
- b) ATO system version that will be used by the ATO-TS for the ATO-OB/ATO-TS communication;
- c) Timeout for ATO-TS response;
- d) Reporting time interval for triggering an STR;

10.1.3.7 **Note:** If there is no ATO major version supported by both ATO-OB and ATO-TS, the ATO-TS will not send an HSAck, but an HSRej asserting that there is no compatible ATO System versions.

10.1.3.8 **Note:** The values of the “Time-out for ATO-TS response” and the “Reporting time interval for triggering an STR” are ATO-TS application specific.

10.1.3.9 The “timeout for ATO-TS response” is used for two different purposes:

- a) It is the maximum time after which the ATO-OB must consider that a request has not been answered;
- b) For determining when the ATO-OB needs to send a JPReq to ensure that a JP is received in a timely manner for continued ATO operation.

10.1.3.10 If ATO-TS answers with an HSRej, the HSRej packet shall mention the following possible reasons for rejection:

ERA * UNISIG * EEIG ERTMS USERS GROUP

- a) ATO-OB and ATO-TS versions are not compatible;
- b) Another ATO-TS is in charge (ATO-TS Contact Information provided);
- c) ATO-TS in charge is unknown (ATO-TS Contact Information not provided).

- 10.1.3.11 An ATO-TS shall perform the version compatibility check only if it is in charge of the ATO-OB.
- 10.1.3.12 If the HSRej indicates that ATO-OB and ATO-TS are not compatible, ATO-OB shall stop trying to open a communication session until the TRN has changed.
- 10.1.3.13 If the HSRej indicates that ATO-TS in charge is not known, ATO-OB shall attempt to re-establish connection with the pre-configured ATO-TS Contact Information.
- 10.1.3.14 If the HSRej indicates that another ATO-TS is in charge, the ATO-TS Contact Information sent back in the HSRej is corresponding to the ATO-TS which is currently in charge of controlling the train. In this case, the ATO-OB shall release the communication and shall establish a new communication session with the ATO-TS Contact Information transmitted in the HSRej packet and start a new handshake process.
- 10.1.3.15 **Note:** TRN is also considered as changed when ETCS-OB reports that the set of ETCS Operational Data has changed to "Valid".

10.1.4 Hand-over between two adjacent ATO-TS

- 10.1.4.1 When the train already has an open communication session with an ATO-TS and it approaches the border of the area controlled by this ATO-TS (called 'handing-over ATO-TS'), the ATO-TS Contact Information of the adjacent ATO-TS (called 'accepting ATO-TS') is given by the last SP referred to by the current JP.
- 10.1.4.2 The ATO-OB shall recover the ATO-TS Contact Information of the Accepting ATO-TS from the last SP referred to in the current JP.
- 10.1.4.3 The ATO-OB shall establish a communication session with the Accepting ATO-TS, by indicating that it is due to a handing over procedure.
- 10.1.4.4 If the ATO-TS receives an HSReq indicating that it is due to a handing over procedure, the ATO-TS shall send an HSAck unless the ATO-OB and ATO-TS versions are not compatible (see 10.1.3.10 a).
- 10.1.4.5 Having established communication with the accepting ATO-TS on the approach to the border, ATO-OB shall maintain communication with the handing over ATO-TS until the rear end of the train has left the last SP referred to by the JP which ends at the boundary between the two adjacent ATO-TS.
- 10.1.4.6 Maximum two communication sessions for ATO OB implies that the area covered by one ATO TS shall be large enough that a previous hand over is complete before the next

border is approached, i.e., large enough to cover the maximum train length plus the distance travelled while contacting the third ATO-TS.

- 10.1.4.7 If the last SP referred to by the current JP does not contain any ATO-TS Contact Information when the train is approaching the border of the area controlled by this ATO-TS, this means that the adjacent area is not fitted for ATO. In this case, the ATO-OB will lose the ATO Operational Conditions when crossing the border according to §9.1.1.1.
- 10.1.4.8 For each border of an ATO-TS the associated list of SPs in the JP shall include at most one SP containing the ATO-TS contact Information, such SP shall be the one which ends at the border and is called "last SP".
- 10.1.4.9 The ATO-OB shall terminate the communication session with the accepting ATO-TS when the handing over ATO-TS sends a JP update where the last SP contains deviating ATO-TS Contact Information (deleted or modified).

10.1.5 Maintaining communication sessions

- 10.1.5.1 A communication session with an ATO-TS shall be considered as lost when:
 - a) The ATO-OB sends an STR and no STRAck is received before the end of the "Timeout for ATO-TS response" mentioned in the HSAck;
 - b) The ATO-OB sends a JPReq and no JP is received before the end of the "Timeout for ATO-TS response" mentioned in the HSAck;
 - c) The ATO-OB sends a SPReq and no SP is received before the end of the "Timeout for ATO-TS response" mentioned in the HSAck.
- 10.1.5.2 If ATO-OB loses a communication session, the ATO-OB shall try to re-establish the communication session using the same ATO-TS Contact Information that was used when establishing the session with the ATO-TS, provided that a targeted TP is available.
- 10.1.5.3 Having reached the last targeted TP within the JP without having recovered the communication, the ATO-OB shall try to open a communication session with the preconfigured ATO-TS Contact Information.
- 10.1.5.4 The ATO-OB shall not send a new STR until the acknowledgement of the previous one has been received except if this is the first STR following a Communication Session establishment.
- 10.1.5.5 The ATO-OB shall not store STRs while the communication session is lost. After re-establishment of the communication session the ATO-OB shall send the latest status in the STR.
- 10.1.5.6 **Note:** A repetition of STR is not foreseen (done at TCP level).
- 10.1.5.7 If a STRAck is received before the "Timeout for ATO-TS response" time has elapsed, the ATO-OB shall continue to compose and send STR.

10.1.6 Communication session termination

10.1.6.1 ATO-OB shall terminate the communication session with a given ATO-TS when one of the following conditions is fulfilled:

- a) End of Journey is reached;
- b) ATO-TS sends a termination session request;
- c) The rear of the train has left this last SP referred to by the JP which ends at the boundary of the ATO-TS;
- d) Cab is closed;
- e) TRN or train length are not valid;
- f) ETCS-OB is in NL Mode or in SH Mode.

10.1.6.2 When terminating a communication session, the ATO-OB shall send a packet SESSTerm to the ATO-TS.

10.1.6.3 **Note:** This SESSTerm packet has not to be acknowledged.

10.1.7 Packet exchange requirements

10.1.7.1 Any packet received by the ATO-OB or the ATO-TS shall be ignored if it is considered as not valid.

10.1.7.2 A packet shall be considered as not valid if one of the following conditions is fulfilled:

- a) Its number is unknown;
- b) Its timestamp is older than the timestamp of a previously received packet with the same number;
- c) Its packet counter has not changed compared to the last previously received packet with the same number;
- d) Any variable uses spare values;
- e) The TRN provided by the ATO-TS does not match the TRN provided by the ETCS-OB;
- f) The ETCS Identity provided by the ATO-TS does not match the ETCS Identity provided by the ETCS-OB.

10.1.7.3 In addition to the previous clause, an acknowledgment packet shall be considered as not valid if the timestamp and the packet counter information is not equal to the corresponding values of the packet to be acknowledged.

10.1.7.4 If it has no JP stored on-board, the ATO-OB shall send a JPReq with an undefined SP as a reference.

ERA * UNISIG * EEIG ERTMS USERS GROUP

- 10.1.7.5 When it receives a JPReq with an undefined SP, the ATO-TS shall send the JP starting from the SP where the train is located (according to the train rear end), if the location of the train inside an SP is available on trackside, otherwise it shall send a JP containing the first SP of the journey.
- 10.1.7.5.1 **Note:** As a precondition it is expected that a Control Centre will always update the Journey Information if the current schedule for the train changes.
- 10.1.7.5.2 **Note:** It is the responsibility of the trackside to ensure that sufficient information is provided to the ATO-OB in the JP. For example, if rear alignment of the train is required at the last TP of the JP, then, as a minimum, the JP information must cover the required location of the train at this TP.
- 10.1.7.6 As long as the received JP does not contain a TP including the information “End of Journey” the ATO-OB shall request JPs from the ATO-TS in due time before reaching the end of the preceding JP according to the “Time-out for ATO-TS response” defined in the HSack and the ATO-OB computation performances.
- 10.1.7.7 The ATO-TS shall answer to any JPReq received from ATO-OB with which a Communication session is established.
- 10.1.7.8 The ATO-OB shall send JPReqs indicating the SP from which a JP is requested.
- 10.1.7.9 Any “valid” JP sent by ATO-TS shall include at least all information to reach one TP.
- 10.1.7.10 **Note:** The purpose of the previous requirement is that each JP shall extend the Journey by, at least, one Timing Point.
- 10.1.7.11 The minimum JP shall contain at least the next Stopping Point. In case a non-stop travel does not fit into one JP, the minimum JP shall contain at least one Passing Point with requested passing time.
- 10.1.7.12 The ATO-TS shall provide JP with no multiple occurrences of the same Segment Profile ID in the associated list of SPs.
- 10.1.7.13 A JP shall include only the TPs not yet passed or departed by the train (see §7.7.1.7).
- 10.1.7.14 In case the train is scheduled to pass at least one Segment Profile ID several times, the ATO-TS shall not send a JP containing any Segment Profile ID that was included in a previous JP until the train has sent a STR from which the ATO-TS concludes that the previous occurrence of the SP has been passed by the rear of the train.
- 10.1.7.15 The ATO-TS shall not send a JP for which there is no existing SP at the ATO-TS level.
- 10.1.7.16 When a JP has already been sent to ATO-OB, the ATO-TS shall be able to update it if necessary by sending a JP with the status “Update”.
- 10.1.7.17 When it receives a “JP Update” from the ATO-TS, the ATO-OB shall discard any previously received JP information from the first SP of the update.

ERA * UNISIG * EEIG ERTMS USERS GROUP

10.1.7.18 When the JP Update affects any JP information starting from the current train position towards the targeted TP, the JP Update shall only be applied once all SP leading to the targeted TP are available on-board.

10.1.7.18.1 **Note:** the old JP stays in use until the updated JP is applied.

10.1.7.19 ATO-OB behaviour after receiving a JP depending on the JP Status:

- a) A "Valid" JP specifies that the data sent is up-to-date and corresponds to the latest JPReq:
 - 1) The ATO-OB shall use the data received from ATO-TS.
- b) An "Unavailable" JP specifies that the requested part of the JP is currently not available but may become available at some point during the journey:
 - 1) The ATO-OB shall use the data it already has stored operating in ATO and shall send no JPReq until it receives a JP with the status "Update" or a new handshake process is performed;
 - 2) The ATO-TS shall send the requested JP with the status "Update" when it is available.
- c) An "Invalid" JP specifies that the SP identifier asserted in the JPReq does not belong to the preceding JP already sent to the ATO-OB:
 - 1) If the ATO-OB is able to prepare a new JPReq with another SP, the ATO-OB shall send a JPReq with that SP identifier;
 - 2) If the ATO-OB is not able to prepare a new JPReq with another SP, the ATO-OB shall send a JPReq with unknown SP identifier.
- d) An "Update" JP specifies that the JP has been updated by the Control Centre modifying or adding information to previously transmitted ones:
 - 1) The ATO-OB shall use the data received from ATO-TS;
 - 2) The ATO-OB shall send the JPack to the ATO-TS using the timestamp and packet counter information of that JP.
- e) An "Overwrite" JP specifies that the previous data sent from any JP has to be discarded and to be replaced with the data sent by that JP:
 - 1) The ATO-OB shall discard any stored JP information;
 - 2) The ATO-OB shall use the data received from ATO-TS;
 - 3) The ATO-OB shall send the JPack to the ATO-TS using the timestamp and packet counter information of that JP.

10.1.7.20 When it receives a JP containing a TP including the information "End of Journey", the ATO-OB shall not send JPReqs to this ATO-TS with the same TRN.

10.1.7.21 Upon receipt of a new JP that includes at least one SP (defined by the identifier and version) in the list of SPs that is not available on-board, the ATO-OB shall send SPReqs for those SPs.

10.1.7.22 **Note:** A single SPReq could include several SP_ID requests.

- 10.1.7.23 The reply of the ATO-TS to an SPReq shall indicate the evaluation status of the request:
- Valid: the requested SP is included;
 - Invalid: the requested SP is not available in the ATO-TS.
- 10.1.7.24 When an SP is received, the ATO-OB shall always be able to store it at least whilst it remains relevant for the current journey.
- 10.1.7.25 When it receives an SP, the ATO-OB shall compare the version number of the SP listed in the JP and the version number of the received one. If they are not the same the reaction described in §7.8.3.2 applies.
- 10.1.7.26 Hereafter are explained the acknowledgement procedures:
- An HSReq sent by the ATO-OB shall be acknowledged by an HSAck sent by the ATO-TS;
 - A JPReq sent by the ATO-OB shall be acknowledged by reception of the corresponding JP coming from the ATO-TS;
 - A “JP Update” sent by the ATO-TS shall be acknowledged by a JPAck sent by the ATO-OB;
 - An SPReq sent by the ATO-OB shall be acknowledged by reception of the corresponding SP coming from the ATO-TS;
 - An STR packet sent by the ATO-OB shall be acknowledged by an STRAck;
 - A “JP Overwrite” sent by the ATO-TS shall be acknowledged by a JPAck sent by the ATO-OB.
- 10.1.7.27 The following diagram and description show an example of a communication sequence after the communication establishment.

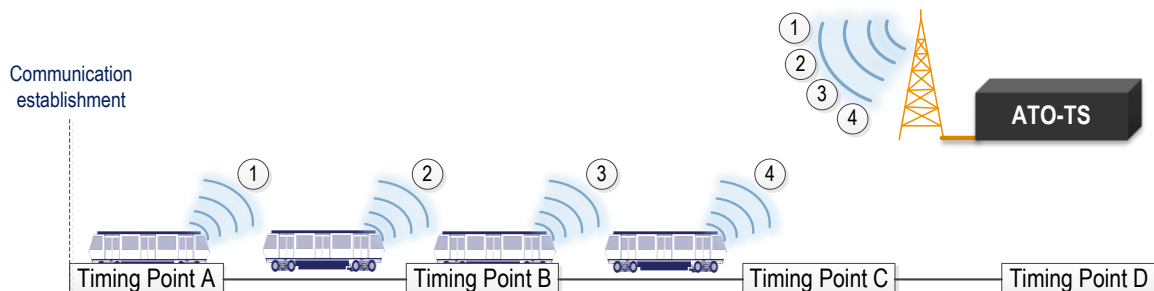

Figure 11 Communication sequence

- Train is at TP A:
 - The ATO-OB requests the JP from the ATO-TS.
 - The ATO-TS sends, at least, the JP until the next TP B to the ATO-OB.
 - The ATO-OB requests the corresponding SPs from the ATO-TS if not already in memory.
 - The ATO-TS sends the SPs to the ATO-OB if there is a request.
- Train is running between TPs A and B:

ERA * UNISIG * EEIG ERTMS USERS GROUP

- a) If there is any updating in the JP, the ATO-TS sends the updated JP to the ATO-OB that replies with a JPack.
- b) At any time, the ATO-OB could request any upcoming JPs.
- c) The ATO-TS sends the requested JPs if available.

- 3) Train is at TP B:
 - a) If the ATO-OB does not have the JP until the next TP C, it is requested from the ATO-TS.
 - b) If there is a request, the ATO-TS sends, at least, the JP until the next TP to the ATO-OB.
 - c) The ATO-OB requests the corresponding SPs from the ATO-TS if not already in memory.
 - d) The ATO-TS sends the SPs to the ATO-OB if there is a request.
- 4) Idem as “2)” but between TPs B and C.

10.1.8 Communication Session Transitions

10.1.8.1 The “communication session management” is based on the following states:

- a) NCE (No Communication Established): in this state, the ATO-OB checks the conditions to start a communication session;
- b) CSR (Communication Session Requested): in this state, the ATO-OB sends an HSReq to the ATO-TS to be connected;
- c) CSE (Communication Session Established): the ATO-OB communicates with the ATO-TS checking conditions to maintain the session established;
- d) CST (Communication Session Terminated): The ATO-OB sends a packet SESSTerm.

10.1.8.2 ATO-OB shall request to establish a connection for any transition to CSR

10.1.8.3 ATO-OB shall release the connection for any transition to CST or NCE.

10.1.8.4 The following figure gives the State Machine Transition Diagram of ATO-OB communicating with one specific ATO-TS:

ERA * UNISIG * EEIG ERTMS USERS GROUP

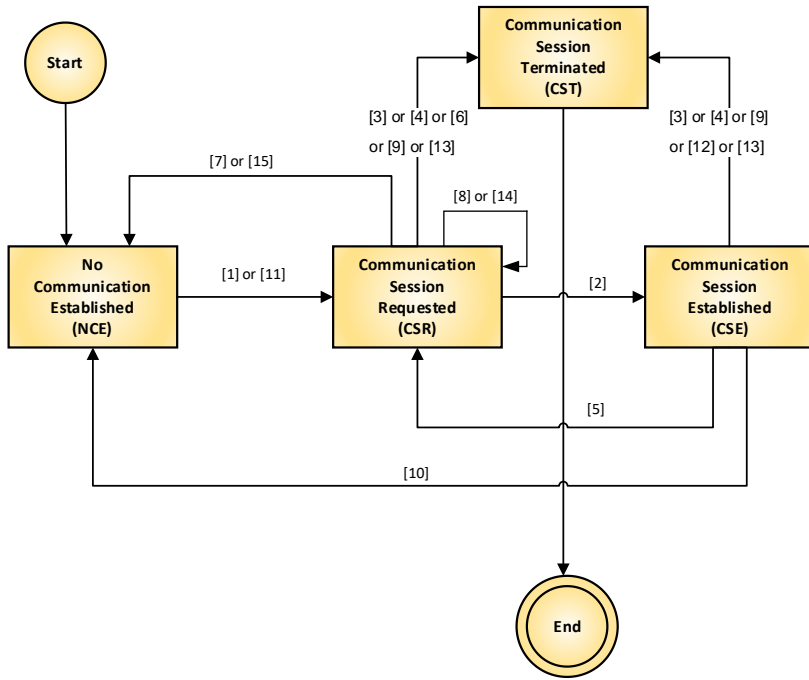

Figure 12 Communication Session State Transitions

10.1.8.5 The table below defines the transitions between states:

NCE	<7,15 -p4-	<7,15 -p4-	<10 -p2-		
1>, 11> -p1-	CSR	<8,14 -p3-			
	8,14> -p3-	CSR	<5 -p3-		
	2> -p2-	2> -p2-	CSE		
	3,4,6,9,13> -p1-	3,4,6,9,13> -p1-	3,4,9,12,13> -p1-	CST	
				Any> -p1-	End

Table 9 Transition table

10.1.8.6 The indication “4>” means: The condition n°4 must be fulfilled to trigger the transition from the state located in the column to the state that is indicated by the arrow “>”.

10.1.8.7 Each transition from a given state receives a priority order (indicated by “-px-”, x is the priority order) to avoid a conflict between the different transitions when they occur at the same time (i.e. in the same clock cycle). P1 has a higher priority than P2.

10.1.8.8 "8, 10, 11" means "8 or 10 or 11".

ERA * UNISIG * EEIG ERTMS USERS GROUP

10.1.8.9 If several consecutive transition conditions are fulfilled at the same time, the ATO-OB State shall transition from the initial state to the final state without performing any action(s) linked to the intermediate state(s).

10.1.8.10 Communication session transition conditions table:

Condition Id	Content of the conditions
[1]	CAB is active and TRN is available and ETCS identity is available and train length is available and ETCS-OB is not in NL Mode or is not in SH Mode and preconfigured ATO-TS Contact Information is to be used.
[2]	HSAck received
[3]	"End of Journey" reached (Stopping Point) or passed (Passing Point or Stopping Point to be skipped)
[4]	TRN has changed
[5]	((ATO-OB sends STR with no STRAck before timeout) or (ATO-OB sends JPReq with no JP before timeout) or (ATO-OB sends SPReq with no SP before timeout)) and A targeted TP is available
[6]	HSRej indicating that ATO-OB and ATO-TS are not compatible
[7]	HSRej indicating that ATO-TS in charge is not known
[8]	HSRej indicating that another ATO-TS is in charge
[9]	CAB is inactive or TRN is not valid or train length is not valid or ETCS-OB is in NL Mode or ETCS-OB is in SH Mode
[10]	((ATO-OB sends STR with no STRAck before timeout) or (ATO-OB sends JPReq with no JP before timeout) or (ATO-OB sends SPReq with no SP before timeout)) and (NO targeted TP is available)
[11]	The JP includes an SP which contains an ATO-TS Contact Information of an adjacent ATO-TS and the ATO-OB decides to establish a communication with the adjacent ATO-TS.
[12]	SESSTermReq sent by ATO-TS
[13]	Rear of the train has left the last SP in rear of the border
[14]	No feedback (HSAck or HSRej) received and, at least, 30 seconds have passed since ATO-OB has sent an HSReq to ATO-TS and a targeted TP is available

Condition Id	Content of the conditions
[15]	No feedback (HSAck or HSRej) received and, at least, 30 seconds have passed since ATO-OB has sent an HSReq to ATO-TS and no targeted TP is available

Table 10 Transition conditions table

10.2 ATO-OB / ETCS-OB interface

10.2.1 Introduction

10.2.1.1 The ATO-OB and the ETCS-OB are connected via an interface over which data is exchanged. The format (packets) of the data is described in [Ref 6], while the requirements about what and when to be exchanged is presented in the remainder of this section §10.2.

10.2.1.2 This section §10.2 also contains some specific requirements for the ATO-OB and ETCS-OB related to the exchange of data over that interface.

10.2.1.3 This section §10.2 is mainly related to data transmitted from ETCS-OB to ATO-OB. The requirements related to data transmitted from ATO-OB to ETCS-OB can be found in other sections of this document.

10.2.1.4 All the data is sent cyclically according to the transmitting cycles specified in [Ref 6], unless where otherwise stated (e.g. Specific ATO Data Entry packets as defined in §7.13.2).

10.2.2 Communication management

10.2.2.1 The ETCS-OB and the ATO-OB shall exchange packets while the connection is established.

10.2.2.2 Both ETCS-OB and ATO-OB shall distinguish between “connection active” and “connection not active” states.

10.2.2.3 The initial state shall be “connection not active”.

10.2.2.4 The state shall change from “connection not active” to “connection active” when for each specified process data, valid packets are received.

10.2.2.5 Both ETCS-OB and ATO-OB shall maintain for each packet a timeout value specified in [Ref 6]. Whenever a valid packet is received the receiver shall reset the specific packet timeout counter.

10.2.2.6 The connection shall be considered as “not active” if one of the timeout counters is triggered.

- 10.2.2.7 **Note:** When the ETCS-OB considers the connection as “not active”, it will change from AD Mode to the applicable ETCS Mode according to the ETCS mode transition table as defined in [Ref 5] §4.6.
- 10.2.2.8 If the timeout is triggered from the ETCS-OB side or if ATO-OB is going to "FA" State, the ETCS-OB shall:
- Start displaying the “ATO Failure” indication;
 - Produce a warning sound for a duration of 5 seconds.
 - Stop the communication with ATO-OB for 10 seconds.
- 10.2.2.9 The ATO-OB shall identify the recently active ETCS-OB by using the active cabin information provided through the train/ATO-OB interface and the ATO-OB specific configuration listing its associated ETCS-OB. Initially the recently active ETCS-OB is not known. Once a cabin is active the ETCS-OB associated to the active cabin becomes the recently active ETCS-OB until the active cabin information changes to a different associated ETCS-OB. Deactivation of a cabin will not change the recently active ETCS-OB.
- 10.2.2.10 The ATO-OB shall transition to FA State if it considers the connection to the recently active ETCS-OB as “not active” while being in any ATO-OB State but CO.
- 10.2.2.11 When ATO-OB is connected to two ETCS-OB, the ATO-OB shall only evaluate information from the recently active ETCS-OB.

10.2.3 General requirements

- 10.2.3.1 Any packet received by the ETCS-OB or the ATO-OB shall be ignored if it is considered as not valid.
- 10.2.3.2 A packet is considered as not valid if one of the following conditions is fulfilled:
- Its number is not known;
 - Its timestamp is older than a previously received packet with the same number;
 - Any variable uses spare values;
 - The computed length of the packet does not correspond to the one indicated in the corresponding variable;
 - The computed Checksum/CRC of the packet does not correspond to the one indicated in the corresponding packet.
- 10.2.3.3 The packets exchanged between the ETCS-OB and the ATO-OB shall include a header containing the following information:
- Packet Number;
 - Packet Length;
 - Timestamp identifying the time at which the packet is sent.

- 10.2.3.4 The dynamic packet sent by the ETCS-OB to the ATO-OB shall contain a timestamp identifying the time at which the current position counter was determined.
- 10.2.3.5 The ETCS-OB shall set the packet timestamp and the timestamp identifying the time at which the current position counter was determined with an accuracy of 1 ms.
- 10.2.3.6 The ETCS-OB shall use the same source of time for the timestamp and the time at which the position counter is determined. As long as ETCS-OB being powered on, the source of time shall be continuously counting without adjustments (e.g. trainborne clock).
- 10.2.3.7 **Note:** The packet timestamp is used together with the time at which the position counter is determined to determine the time elapsed since the variables were composed (see §7.10.1.1 e) and §7.10.1.3 e)).
- 10.2.3.8 While low adhesion is selected by the driver, the ETCS-OB shall report the information “slippery rail” to the ATO-OB (see §7.5.1.1).

10.2.4 ETCS Data

- 10.2.4.1 While no valid ETCS Train Data is available, the ETCS-OB shall send the information “ETCS Train Data not valid” to the ATO-OB and shall send no Train Data.
- 10.2.4.2 While valid ETCS Train Data is available, the ETCS-OB shall send the information “ETCS Train Data valid” and the data defined in §7.13.1.1 to the ATO-OB.
- 10.2.4.3 While the TRN or the Driver ID is not validated, the ETCS-OB shall send the information “ETCS Operational Data not valid” to the ATO-OB and shall not send their values.
- 10.2.4.4 While the TRN and the Driver ID are validated, the ETCS-OB shall send the information “ETCS Operational Data valid” to the ATO-OB and shall send their values.

10.2.5 Position data

- 10.2.5.1 The ETCS-OB shall send its raw position counter information.
- 10.2.5.2 The position counter shall be estimated less than 200 ms before the beginning of sending of the corresponding packet.
- 10.2.5.3 The position counter shall increase when the train is moving in positive movement direction. It shall decrease when the train is moving in negative movement direction. The ETCS-OB shall also indicate to the ATO-OB whether a movement in the direction of the train orientation corresponds to an increase or a decrease of the raw counter.
- 10.2.5.4 All the position counter values shall be such that the absolute value of the difference between the current position counter and the position counter at the time when the Location Reference Balise of the ETCS SOLR was detected corresponds to the estimated front end as used by the ETCS-OB, when it is augmented/diminished (depending whether a movement in the direction of the train orientation corresponds to an increase or a decrease of the raw counter respectively) by the distance between the

antenna active at the time when the Location Reference Balise of the ETCS SOLR was detected and the front end of the train.

- 10.2.5.5 **Note:** Positive movement direction is defined as a movement in the forward direction in relation to cab A.
- 10.2.5.6 **Note:** Negative movement direction is defined as movements in the backwards direction in relation to cab A.
- 10.2.5.7 **Note:** Allocation of cab(s) on a specific train is a pure ETCS-OB implementation issue.
- 10.2.5.8 The ETCS-OB shall not reset the position counter as long as the ETCS-OB is powered-on.
- 10.2.5.9 The position counter shall not be decreased or increased in case of repositioning or relocation.
- 10.2.5.10 The position counter shall wrap around when exceeding the value range.
- 10.2.5.11 The maximum value of the position counter is a special value "NOT ALLOWED". This is used as an unknown value in other variables which depend on this counter and shall not be sent as a normal value, instead the maximum but one value shall be sent.
- 10.2.5.12 All the position counter related variables sent by the ETCS-OB (except the passed balise related ones) are obtained by adding/subtracting the distances to the relevant location items (possibly resulting from repositioning or relocation) to/from the position counter value of the SOLR, depending whether a movement in direction of the train orientation corresponds to an increase or a decrease of the raw counter respectively.
- 10.2.5.13 For all the variables sent by ETCS-OB and related to the position counter, instead of the maximum value, the maximum but one value shall be sent.
- 10.2.5.14 The ETCS-OB shall send to the ATO-OB the confidence interval to the train position from the SOLR (see [Ref 5] §3.6.4.1.1).

10.2.6 Balise information

- 10.2.6.1 The ETCS-OB shall use the identification of a balise of a BG as the identification of the reference balise in the packets sent to the ATO-OB once the ETCS-OB considers the corresponding BG to be the SOLR.
- 10.2.6.2 The ETCS-OB shall send balise information (including balise identification, value of the position counter, time when the balise was passed and identification of the active antenna when the balise was passed) of the two last passed balises and of the LRBG to the ATO-OB.
- 10.2.6.3 The ETCS-OB shall send to the ATO-OB the information about passed balises within the first 1 second after a telegram is received from the balise and has passed the telegram consistency checks (see [Ref 5] §A.3.3.1) successfully.

- 10.2.6.4 **Note:** In case more than two balises are passed within the cyclic transmission time, the ETCS-OB may not transmit some of them to the ATO-OB.
- 10.2.6.5 The ETCS-OB shall store the identifier and position of the two last balises passed and the SOLR as this information is cyclically transmitted to the ATO-OB. The information about the two last balises passed shall follow the same rules as the information "Train position" ([Ref 5] §3.6.1.3), e.g. when the ETCS-OB is powered off.
- 10.2.6.6 The ETCS-OB shall send to the ATO-OB the "orientation of the train in relation to the direction of the SOLR" and the "position of the front end of the train in relation to the SOLR" (defined for SOLR by analogy to LRBG as defined in [Ref 5] §3.6.5).
- 10.2.6.7 The ETCS-OB shall send linking information (including balise identification, and estimated value of the position counter at the announced balise group) for the next linked balise groups known by the ETCS-OB in the same order as received from ETCS Trackside.

10.2.7 Supervision information

- 10.2.7.1 While being in AD, FS or OS, the ETCS-OB shall send supervision data to the ATO-OB.
- 10.2.7.2 The ETCS-OB shall send the location of the closest EBI supervision limit for the current speed of the train.
- 10.2.7.3 The ETCS-OB shall send to the ATO-OB the list of applicable A_GRADIENT (d) (determined as per [Ref 5] §3.13.6.2.1.3) and A_MAXREDADH (d) (see §10.2.7.6) over a distance range covering at least:
- In case of EOA/SvL, the distance from the max safe front end of train to the SvL;
 - In case of LOA, the distance from the max safe front end of train to furthest location between the LOA and the furthest supervised target beyond the LOA whose speed value is lower than the LOA speed value, if any.
- 10.2.7.4 Over the distance range specified in §10.2.7.3, the ETCS-OB shall send up to 51 A_GRADIENT (d) including:
- Up to 50 gradient values as defined in [Ref 12] §4.3.2.1.1 f).
 - A special value to close the profile.
- 10.2.7.5 A_GRADIENT (d) shall be equal to:
- A_GRADIENT₁ when $d_{\text{maxsafe}} \leq d \leq N_LOC_GRADCHANGE_1$;
- A_GRADIENT₂ when $N_LOC_GRADCHANGE_1 < d \leq N_LOC_GRADCHANGE_2$;
- ...
- A_GRADIENT_n when $N_LOC_GRADCHANGE_{n-1} < d \leq N_LOC_GRADCHANGE_n$,
- Where:
- A_GRADIENT_x is the acceleration/deceleration value due to gradient;
- N_LOC_GRADCHANGE_x is the value of the position counter at the gradient change.

ERA * UNISIG * EEIG ERTMS USERS GROUP

- 10.2.7.6 In order to send to the ATO-OB a continuous profile $A_MAXREDADH(d)$, the ETCS-OB shall take into account:
- The locations with reduced adhesion conditions and the locations with change of special brake(s) contribution (see [Ref 5] §3.13.5);
 - The brake position and whether special/additional brakes independent from wheel/rail adhesion are active and it is allowed to take into account their contribution to the emergency braking effort (see [Ref 5] §3.13.6.2.1.6).
- 10.2.7.7 Over the distance range specified in §10.2.7.3, the ETCS-OB shall send up to 22 $A_MAXREDADH(d)$ including:
- The adhesion conditions between the max safe front end of the train and the first adhesion conditions change;
 - Up to 20 changes of adhesion conditions as defined in [Ref 12] §4.3.2.1.1 q) (the maximum would be 10 start locations plus 10 end locations);
 - A special value to close the profile.
- 10.2.7.8 $A_MAXREDADH(d)$ shall be equal to:
- $A_MAXREDADH_1$ when $d_{maxsafe\ front} \leq d \leq N_LOC_ADHCHANGE_1$;
- $A_MAXREDADH_2$ when $N_LOC_ADHCHANGE_1 < d \leq N_LOC_ADHCHANGE_2$;
- ...
- $A_MAXREDADH_n$ when $N_LOC_ADHCHANGE_{n-1} < d \leq N_LOC_ADHCHANGE_n$,
- Where:
- $A_MAXREDADH_x$ is the maximum deceleration value due to adhesion conditions or specifies that there is no maximum deceleration due to reduced adhesion conditions;
- $N_LOC_ADHCHANGE_x$ is the value of the position counter at the adhesion conditions change.
- 10.2.7.9 The ETCS-OB shall send to the ATO-OB the safe emergency brake deceleration ($A_BRAKE_SAFE(d,V)$) (see [Ref 5] 3.13.6.2.1.4) values over a speed and distance range covering at least:
- In case of EOA/SvL:
 - The distance from the max safe front end of train to the SvL;
 - The speeds from 0 to the maximum MRSP speed value encountered within the above distance, augmented by dv_EBI calculated for this MRSP max speed value, by V_DELTA0 , by V_delta1 and by V_delta2 .
 - In case of LOA:
 - The distance from the max safe front end of train to furthest location between the LOA and the furthest supervised target beyond the LOA whose speed value is lower than the LOA speed value, if any;
 - The speeds from the lowest value between the LOA speed and the minimum MRSP speed value encountered within the above distance to the maximum MRSP speed value encountered within the above distance, augmented by

ERA * UNISIG * EEIG ERTMS USERS GROUP

dv_EBI calculated for this MRSP max speed value, by V_DELTA0, by V_delta1 and by V_delta2.

- 10.2.7.10 Over the speed range specified in §10.2.7.9, the ETCS-OB shall send up to 10 A_BRAKE_SAFE (V) values for the current applicable values and for each location with a change of the safe emergency brake deceleration model (see [Ref 5] §3.13.2.3.7.11, A.3.7.4&5).
- 10.2.7.11 Over the distance range specified in §10.2.7.9, the ETCS-OB shall send up to 40 changes of safe emergency brake deceleration models as defined in [Ref 12] § 4.3.2.1.1 l) (the maximum would be 20 start locations plus 20 end locations).
- 10.2.7.12 Based on the following example:

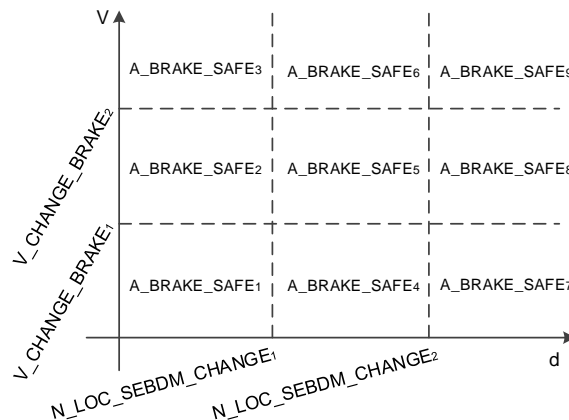

Figure 13 Example for sending safe emergency brake deceleration values

- 10.2.7.13 The ETCS-OB shall send to the ATO-OB the safe emergency brake deceleration as a function of the speed and the locations with change of special brake(s) contribution encountered. A_BRAKE_SAFE (V,d) shall be equal to:

A_BRAKE_SAFE₁ when $(0 \leq V \leq V_CHANGE_BRAKE_1)$ AND $(d_{maxsafefront} \leq d \leq N_LOC_SEBDM_CHANGE_1)$

A_BRAKE_SAFE₂ when $(V_CHANGE_BRAKE_1 < V \leq V_CHANGE_BRAKE_2)$ AND $(d_{maxsafefront} \leq d \leq N_LOC_SEBDM_CHANGE_1)$

A_BRAKE_SAFE₃ when $(V_CHANGE_BRAKE_2 < V)$ AND $(d_{maxsafefront} \leq d \leq N_LOC_SEBDM_CHANGE_1)$

A_BRAKE_SAFE₄ when $(0 \leq V \leq V_CHANGE_BRAKE_1)$ AND $(N_LOC_SEBDM_CHANGE_1 < d \leq N_LOC_SEBDM_CHANGE_2)$;

A_BRAKE_SAFE₅ when $(V_CHANGE_BRAKE_1 < V \leq V_CHANGE_BRAKE_2)$ AND $(N_LOC_SEBDM_CHANGE_1 < d \leq N_LOC_SEBDM_CHANGE_2)$;

A_BRAKE_SAFE₆ when $(V_CHANGE_BRAKE_2 < V)$ AND $(N_LOC_SEBDM_CHANGE_1 < d \leq N_LOC_SEBDM_CHANGE_2)$;

A_BRAKE_SAFE₇ when $(0 \leq V \leq V_CHANGE_BRAKE_1)$ AND $(N_LOC_SEBDM_CHANGE_2 < d)$;

ERA * UNISIG * EEIG ERTMS USERS GROUP

$A_BRAKE_SAFE_8$ when $(V_CHANGE_BRAKE_1 < V \leq V_CHANGE_BRAKE_2)$ AND $(N_LOC_SEBDM_CHANGE_2 < d)$;

$A_BRAKE_SAFE_9$ when $(V_CHANGE_BRAKE_2 < V)$ AND $(N_LOC_SEBDM_CHANGE_2 < d)$,

Where:

$A_BRAKE_SAFE_x$ is the maximum deceleration value due to the safe emergency brake deceleration;

$V_CHANGE_BRAKE_x$ is the value of the safe emergency brake deceleration model change due to the speed;

$N_LOC_SEBDEM_CHANGE_x$ is the location of a safe emergency brake deceleration model change due to the location.

10.2.7.14 The ETCS-OB shall send to the ATO-OB the Most Restrictive Speed Profile (MRSP) computed by the ETCS-OB (see [Ref 5] §3.13.7) as a most restrictive speed depending on the location ($V_MRSP(d)$). The V_MRSP shall be equal to:

V_MRSP_1 when $d_{\text{minsafe}} \leq d \leq N_LOC_MRSP_1$;

V_MRSP_2 when $N_LOC_MRSP_1 < d \leq N_LOC_MRSP_2$;

...

V_MRSP_n when $N_LOC_MRSP_{n-1} < d \leq N_LOC_MRSP_n$,

Where:

V_MRSP_x is the most restrictive speed restriction;

$N_LOC_MRSP_x$ is the value of the position counter at the most restrictive speed change.

10.2.7.15 The ETCS-OB shall send to the ATO-OB the location and permitted speed of the most relevant EOA or LOA (including temporary EOAs) and the Supervised Location.

10.2.7.16 The ETCS-OB shall send to the ATO-OB the current applicable values of the:

- a) Time during which the traction effort is still present after the Emergency brake intervention;
- b) Brake reaction time during which the braking effort is not yet present after the Emergency brake intervention;
- c) Remaining time during which the traction effort is not present until the equivalent brake build up time elapses after the Emergency brake intervention;
- d) Compensation of the inaccuracy of the speed measurement;
- e) Current estimated train speed;
- f) Current estimated train acceleration.

10.2.7.17 In CSM, TSM and RSM, the ETCS-OB shall send to the ATO-OB the current permitted speed, the current release speed and the current RSM start location.

10.2.7.18 The estimated speed and the estimated acceleration shall be estimated less than 200ms before the beginning of the sending of the corresponding packet.

10.2.8 Driver inputs

- 10.2.8.1 If the ETCS-OB is in AD Mode, when the driver selects “ATO Engage”, the ETCS-OB shall increase the value of the “ATO Engage selection counter”.
- 10.2.8.2 If the ETCS-OB is not in AD Mode, when the driver selects “ATO Engage”, the ETCS-OB shall increase the value of the “ATO Engage selection counter” only after changing to AD Mode.
- 10.2.8.3 When the driver selects “Skip Stopping Point Request”, the ETCS-OB shall increase the value of the “Skip Stopping Point Request selection counter”.
- 10.2.8.4 When the driver selects “Skip Stopping Point Revocation”, the ETCS-OB shall increase the value of the “Skip Stopping Point Revocation selection counter”.
- 10.2.8.5 The ETCS-OB shall increase the value of any driver input selection counter not later than 500 ms after the input is selected.
- 10.2.8.6 The ATO-OB shall consider that the driver has selected a DMI input when the value of the related counter is increased between two packets.

10.2.9 Configuration Management

- 10.2.9.1 The following table lists the configuration data related to the ATO-OB/ETCS-OB interface, which shall be considered for offline agreement.

Nr.	Configuration Items	Description
1.	Sets of full service brake models and their corresponding indexes	See [Ref 5] §3.13.2.2.3.1 See §7.13.1.2 to §7.13.1.5.
2.	Normal service brake models together with their corresponding brake position and pivot values	See [Ref 5] §3.13.2.2.3.1.9 and §3.13.2.2.3.1.10 See §7.13.1.5 b).
3.	List of cabins and their associated ETCS-OB	See §10.2.2.9.

Table 11 Configuration Items

10.3 ATO-OB / Rolling Stock Interface

10.3.1 Configuration management

10.3.1.1 The following table lists the configuration data to be agreed between ATO supplier and Rolling Stock supplier related to the ATO-OB/RST interface, which shall be considered by the ATO supplier for offline agreement.

Nr.	Configuration Items	Description
1.	Brake architecture category	C-type trains or S-type trains
2.	Direct brake control by ATO-OB	Used or not
3.	Train doors control by ATO-OB	Doors control available yes or no
4.	RST timeout response	Timeout to consider that feedback signals are consistent with ATO-OB control signals.
5.	Dynamic brake force limitation	Applied by the train or by ATO-OB (see clause 7.1.5.9).

Table 12 Configuration Items

11. CONFIGURABILITY

11.1 Description

- 11.1.1.1 The ATO-OB shall be independent of trackside configuration and shall operate on updated data received from the ATO-TS in the form of updated versions of JPs and SPs.
- 11.1.1.2 Line extensions and modifications of trackside layout shall be configurable in the ATO-TS.