



INTERNATIONAL UNION  
OF RAILWAYS

# **Future Railway Mobile Communication System**

## **Functional Interface Specification**

<b>Source</b>	<b>UIC</b>
<b>Date</b>	<b>30<sup>th</sup> of April 2025</b>
<b>UIC Reference</b>	<b>FIS-7970</b>
<b>Version</b>	<b>2.1.0</b>
<b>Number of pages</b>	<b>120</b>

ISBN 978-2-7461-3127-9

**Warning**

No part of this publication may be copied, reproduced or distributed by any means whatsoever, including electronic, except for private and individual use, without the express permission of the International Union of Railways (UIC). The same applies for translation, adaptation or transformation, arrangement or reproduction by any method or procedure whatsoever. The sole exceptions – noting the author’s name and the source –are “analyses and brief quotations justified by the critical, argumentative, educational, scientific or informative nature of the publication into which they are incorporated” (Articles L 122-4 and L122-5 of the French Intellectual Property Code).

© International Union of Railways (UIC) – Paris, 2025

## Document History

Version	Date	Details
0.2.0	21/01/2022	Stable draft for input to EECT process
0.3.0	14/04/2022	Amendments from the first round of EECT review process and from parallel FIS WG work.
0.4.0	06/05/2022	Amendments from the second round of EECT review process.
0.5.0	19/08/2022	Amendments based on latest outcomes from FIS WI.1 (IDs), WI.2 (REC) and WI.3 (ETCS), taking into account the latest ATWG decisions for open topics highlighted in EECT review process.
0.6.0	23/09/2022	Amendments from last EECT review round (EECT meeting on 9/09/2022)
0.7.0	10/10/2022	Amendments from last EECT review round (EECT meeting on 7/10/2022)
1.0.0	13/02/2023	Amendments related to FIS/FFFIS definitions alignment, categorisation annex and some other remarks received from ERA on 08/02/2023
1.1.0	29/03/2024	Stable draft for input to EECT process
1.2.0	17/05/2024	Updated stable draft for input to EECT process
1.2.1	09/08/2024	Updated version after first EECT review cycle process
1.2.2	27/09/2024	Updated version after second EECT review cycle process
1.2.3	08/11/2024	Updated version after third EECT review cycle process
1.2.4	05/12/2024	Updated version after fourth EECT review cycle process
2.0.0	12/12/2024	Final version after editorial review
2.1.0	29/04/2025	Final version with EU MI classification (Annex B)

## List of definitions

Addressed Area	Predefined geographical area used in the addressing mechanism of a communication to determine whether a user has to be included in the communication. This geographical area is configured by the FRMCS administrator and is assigned with an identity which will be used for call setup.
FRMCS Application Category	A category assigned to a FRMCS application used to determine what must be the behaviour of the end user's device based on arbitration rules specified in [FRMCS FRS].
Railway Application	Provides a solution for a specific railway operations need (railway communication, railway signalling, railway security...) as e.g. VAS, ATP, DSD, CCTV, passenger announcements...
FFFIS App Category	According to [FRMCS FFFIS] terminology.
FRMCS Application	According to [FRMCS FRS] terminology.
FRMCS System	Telecommunication system conforming to FRMCS specifications, consisting of Transport Stratum and Service Stratum.
Home Service Domain	The MC User's primary security domain called Home Security Domain in [TS 33.180].
Initiating Area	Predefined geographical area where is located the initiator of a communication and which determines the addressing rules used for the selection of the users to be included in the communication. This geographical area is configured by the FRMCS administrator and is assigned with an identity which will be used for call setup.
Local Binding	Establishment of a mandatory secure link between a Railway Application and the FRMCS, ensuring mutual authentication of both parties through the $OB_{app}/TS_{app}$ as well as the integrity and confidentiality of their information exchanges related to the $OB_{app}/TS_{app}$ control plane (see specification of Local Binding in [FRMCS FFFIS]).
Location Area	Geographical area used in the addressing mechanism of a communication (e.g. initiating and addressed area).
MCX Client	A generic name for the client application function of a specific MC service. MCX client could be replaced by MCPTT client, or MCVIDEO client, or MCDATA client depending on the context. It corresponds to the MC Service Client as defined in [TS 23.280].
MCX Server	A generic name for the server application function of a specific MC service. MCX Server could be replaced by MCPTT server, MCVIDEO server, or MCDATA server depending on the context. It corresponds to the MC Service Server as defined in [TS 23.280].
MC User	A user of the mission critical services, identified by an MC ID, who, after authorization, obtains access to mission

	critical service(s) as defined in [TS 23.280] and gets it's MC Service ID(s) provided as defined in [TS 33.180].
MC User Identity (MC ID)	The identity of an MC User used for the MCX authentication and authorisation processes in order to get access to mission critical service(s) thanks to its credentials as defined in [TS 23.280].
MC Service User Identity (MC Service ID)	The identity to be used for a specific MC service (MCPTT, MCVIDEO, or MCDATA) to setup a communication to an MC User as soon as authorised for the corresponding mission critical service as defined in [TS 23.280].
MC Service User	An authorized user, who can use an MC service UE to participate in one or more MC services as defined in [TS 23.280].
On-Board FRMCS	According to [FRMCS TOBA FRS] terminology.
FRMCS Service Domain	Implementation of (parts of) the Service Stratum which belongs to and/or is operated by a unique organisation.
Service Stratum	Communication Services and Complementary Services.
Session / Service Session	FRMCS service session between FRMCS service clients.
Token	Prior to connecting to the MC domain, the MC User application requires a 'token' authorising its access to MC services. To obtain authorisation token(s), the MC User application authenticates the MC User to an Identity Management Server (IdM Server) which provides the authorisation token (See [TS 33.180]).
FRMCS Trackside Gateway	System enabling FRMCS communication to trackside Railway Applications. The FRMCS Trackside Gateway achieves a decoupling between trackside Railway Application(s) and FRMCS Transport Domain. For some applications, the decoupling is also achieved for the FRMCS Service Domain.
FRMCS Transport Domain	According to [FRMCS SRS] terminology.
User	A human user or a Railway Application making use of the FRMCS.
User Alias	An MCX Functional Alias used as User Identity and possibly assigned to a user upon user login.
MC User Authentication	The process to verify the identity of an MC User in the Identity Management Server which provides the access to MC services.
MC User Service Authorisation	The process that validates if an MC User has the authority to use a specific MC service.
User Equipment	Combination of hardware and software required to use the FRMCS System
User Identity	According to [FRMCS FRS] terminology.
User Registration	The union of the MC User Authentication and the MC User Service Authorisation processes.

Visited Service Domain

A MC service domain delivering services to an MC user having another service domain as primary security domain.

## List of abbreviations

3GPP	3rd Generation Partnership Project
API	Application Programming Interface
ATO	Automatic Train Operation
ATO-TS	ATO Trackside entity
ATP	Automatic Train Protection
CCTV	Closed-Circuit Television
DNS	Domain Name Service
DSD	Driver Safety Device
ETCS	European Train Control System
ETSI	European Telecommunications Standards Institute
ERA	European Union Agency for Railways
FIS	Functional Interface Specification
FRMCS	Future Railway Mobile Communication System
FSD	FRMCS Service Domain
GNSS	Global navigation satellite system
GSM-R	Global System for Mobile communications – Railway
H2H	Host-to-Host
H2N	Host-to-Network
IdMS	Identity Management Server
IFSDT	Inter FRMCS Service Domain Transition
IMS	IP Multimedia Subsystem
IP	Internet Protocol
IPcon	IP Connectivity
KMS	Key Management System
LAN	Local Area Network
LC	Loose-Coupled
MCX	Mission Critical Services (MCX stands for MCPTT or MCVIDEO or MCDATA)
MCDATA	Mission Critical Data
MC ID	Mission Critical user Identity
MCPTT	Mission Critical Push-To-Talk
MC Service ID	Mission Critical Service User Identity
MCVIDEO	Mission Critical Video
MCX ID H	Mission Critical Service User Identity in Home domain
MCX ID S	Mission Critical Service User Identity in Served domain
MCX ID T	Mission Critical Service User Identity in Target domain

NCGI	NR Cell Global Identity
NTT	Network Transition Trigger
OB	Onboard
OB <sub>app</sub>	Onboard Application reference point/interface
PDN	Packet Data Network
PKI	Public Key Infrastructure
RBC	Radio Block Centre
REC	Railway Emergency Communication
SIP	Session Initiation Protocol
SLC	Super Loose-Coupled
TC	Tight-Coupled
TCMS	Train Control and Management System
TR	Technical Report
TS	Technical Specification
TS <sub>app</sub>	Trackside Application reference point/interface
UE	User Equipment
UIC	Union Internationale des Chemins de fer
UNISIG	Union Industry of Signaling
URI	Uniform Resource Identifier
VAS	Voice Application Subsystem
WLAN	Wireless Local Area Network



## Normative references

N1 [FRMCS FRS]	FRMCS Functional Requirements Specification FU-7120 Version 2.0.0 UIC
N2 [FRMCS SRS]	FRMCS System Requirements Specification FW-AT-7800 Version 2.0.0 UIC
N3 [FRMCS FFFIS]	FRMCS Form Fit Functional Interface Specification FW-AT-7950 Version 2.0.0 UIC
N4 [FRMCS TOBA FRS]	FRMCS Telecom Onboard System – Functional Requirements Specification TOBA-7510 Version 2.0.0 UIC
N5 [TS 23.379]	Functional architecture and information flows to support Mission Critical Push To Talk (MCPTT); Stage 2 TS 23.379 3GPP
N6 [TS 23.280]	Common functional architecture to support mission critical services; Stage 2 TS 23.280 3GPP
N7 [TS 23.282]	Functional architecture and information flows to support Mission Critical Data (MCDATA); Stage 2 TS 23.282 3GPP
N8 [TS 24.282]	Mission Critical Data (MCDATA) signalling control; Protocol specification TS 24.282 3GPP
N9 [TS 24.379]	Mission Critical Push To Talk (MCPTT) call control; Protocol specification TS 24.379 3GPP
N10 [TS 24.380]	Mission Critical Push To Talk (MCPTT) media plane control; Protocol specification TS 24.380 3GPP
N11 [TS 24.482]	Mission Critical Services (MCS) identity management; Protocol specification TS 24.482 3GPP
N12 [TS 24.484]	Technical Specification Group Core Network and Terminals; Mission Critical Services (MCS) configuration management; Protocol specification TS 24.484 3GPP
N13 [TS 33.180]	Security of the Mission Critical (MC) service; TS 33.180 3GPP
N14 [SUBSET-098]	RBC-RBC Safe Communication Interface Subset-098 UNISIG
N15 [SUBSET-037-1]	EuroRadio FIS - CS/PS Communication Function Module Subset-037-1 UNISIG
N16 [SUBSET-037-3]	EuroRadio FIS - FRMCS Communication Function Module Subset-037-3

	UNISIG
N17 [TS 103 765-1]	Rail Telecommunications (RT); Future Rail Mobile Communication System (FRMCS); Building Blocks and Functions; Part 1: Transport Stratum TS 103 765-1 ETSI
N18 [TS 103 765-3]	Rail Telecommunications (RT); Future Railway Mobile Communication System (FRMCS); Part 3: Train Onboard functions and interfaces TS 103 765-3 ETSI
N19 [TS 103 765-4]	Rail Telecommunications (RT); Future Railway Mobile Communication System (FRMCS); Part 4: trackside functions and interfaces TS 103 765-4 ETSI

Notes:

- normative references are either specific (identified by date of publication, edition number, version number, etc.) or non-specific. For a specific reference, subsequent revisions do not apply. For a non-specific 3GPP reference, the latest frozen applies. For other non-specific reference, the latest published version applies.
- in case of contradicting or incomplete definitions and specifications within 3GPP documents, the so-called "stage 3" specifications (protocol specifications) shall take precedence over other 3GPP technical specifications.

## Informative references

# Table of Contents

Document History .....	3
List of definitions .....	4
List of abbreviations .....	7
Normative references .....	9
Informative references .....	11
Table of Contents.....	12
Table of figures and tables.....	16
1. Introduction.....	18
1.1. Purpose .....	18
1.2. Scope .....	18
1.3. Categorisation of the clauses.....	21
1.4. FRMCS services access modes .....	22
1.4.1. Foreword .....	22
1.4.2. OB <sub>app</sub> tight-coupled mode .....	24
1.4.3. OB <sub>app</sub> Loose-coupled mode.....	25
1.4.4. TS <sub>app</sub> Tight-coupled mode.....	26
1.4.5. TS <sub>app</sub> Loose-coupled mode .....	26
1.4.6. Direct access mode .....	27
1.5. Local Binding function.....	27
2. Service Session in gateway access mode.....	28
2.1. Service Session for LC .....	28
2.1.1. Introduction.....	28
2.1.2. User Registration request .....	28
2.1.3. Session Start request.....	30
2.1.4. Session End request.....	34
2.1.5. Incoming session start notification .....	35
2.2. Service Session for TC mode .....	36
2.2.1. Introduction.....	36
2.2.2. User Registration request .....	36
3. Common functions requirements .....	38
3.1. Role management.....	38
3.1.1. Introduction.....	38
3.1.2. User Identities.....	39
3.1.2.1. User login .....	39
3.1.2.2. User Identities for ATP and ATO applications .....	40
3.1.2.3. User Identities for REC and VOICE communications.....	40

3.1.3.	Functional identities .....	41
3.1.3.1.	General.....	41
3.1.3.2.	Registration of functional identities.....	41
3.1.3.3.	De-registration of functional identities .....	41
3.1.3.4.	Interrogation of functional identities.....	41
3.1.3.5.	Transfer and hand-over of functional identities.....	42
3.1.3.6.	Automatic activation and de-activation of functional identities .....	42
3.1.3.7.	Usage of functional identities .....	42
3.2.	Location services common function .....	43
3.2.1.	Source of Location information .....	43
3.2.2.	Location reporting .....	43
3.3.	Arbitration common function .....	46
3.3.1.	Introduction.....	46
3.3.2.	General.....	46
3.4.	Inter-FRMCS-Service-Domain Transition.....	48
3.4.1.	Introduction.....	48
3.4.2.	Context .....	48
3.4.3.	Inter FRMCS Service Domain Transition (IFSDT) Procedure.....	49
4.	FRMCS Applications requirements .....	52
4.1.	Automatic train protection .....	52
4.1.1.	Introduction.....	52
4.1.2.	ATP User Registration .....	52
4.1.3.	Use of FRMCS location services.....	53
4.1.4.	QoS and priority.....	53
4.1.5.	Handling of an ATP Session .....	53
4.1.5.2.	Session Start .....	53
4.1.5.3.	Session End .....	53
4.1.6.	Handling of ATP-TS User responsibility handover .....	54
4.1.6.1.	Introduction.....	54
4.1.6.2.	Handover between ATP-TS Users in a same service domain .....	55
4.1.6.3.	Handover between ATP-TS Users in different service domains .....	55
4.1.7.	Handling of a PKI and KMS Sessions .....	59
4.1.7.1.	General information .....	59
4.1.7.2.	Session Start .....	59
4.1.7.3.	Session End .....	59
4.1.7.4.	Inter-FRMCS-Service-Domain Transition for PKI & KMS .....	60
4.2.	Automatic train operation .....	61

4.2.1.	Introduction.....	61
4.2.2.	ATO User Registration.....	61
4.2.3.	Use of FRMCS location services.....	61
4.2.4.	QoS and priority.....	61
4.2.5.	Handling of an ATO Session.....	62
4.2.6.	Handling of ATO-TS responsibility handover.....	62
4.2.7.	Handling of a PKI (Security Certificate management) Session.....	62
4.3.	Railway emergency communication.....	63
4.3.1.	Introduction.....	63
4.3.2.	REC User Registration and Role Management.....	63
4.3.3.	REC Types.....	63
4.3.4.	REC principles.....	64
4.3.5.	QoS and priority.....	66
4.3.6.	REC flows.....	66
4.3.6.1.	General.....	66
4.3.6.2.	REC flow for setup.....	67
4.3.6.3.	REC flow for entry and leaving addressed area.....	70
4.3.6.4.	REC flow for change of User's eligibility criteria.....	73
4.3.6.5.	REC Alert flow for setup.....	75
4.3.6.6.	REC Alert flow for entry and leaving addressed area.....	77
4.3.6.7.	REC Alert flow for change of eligibility criteria.....	80
4.3.6.8.	REC-voice communication flow for floor request.....	83
4.3.6.9.	Termination of REC.....	83
4.3.6.10.	Ad hoc Group call criteria definition.....	84
4.3.6.11.	Ad hoc Group call server based parameter definition.....	86
4.3.7.	Additional REC requirements.....	86
4.3.8.	Floor Control requirements.....	87
4.4.	Voice communications.....	88
4.4.1.	Introduction.....	88
4.4.2.	Voice communication User Registration and Role Management.....	88
4.4.3.	Voice communication principles.....	88
4.4.4.	QoS and priority.....	89
4.4.5.	Voice communication flows.....	89
4.4.5.1.	Message flow for voice communication from driver towards the controller(s).....	89
4.4.5.2.	Message flow for voice communication from controller towards driver.....	91
4.4.5.3.	Message flow for multi-train voice communication initiated by Driver.....	93
4.4.5.4.	Message flow for multi-train voice communication initiated by controller.....	95

4.4.5.5. Message flow for controller to controller(s) voice communication using ad-hoc group call .....	97
4.4.5.6. Message flow for controller to controller voice communication using private call	99
4.4.5.7. Message flow for leaving an ad-hoc group call.....	99
4.4.5.8. Message flow for adding a participant to an on-going ad-hoc group call .....	99
4.4.5.9. Message flow for pseudo-merging of two on-going voice communication ....	101
4.4.5.10. Floor request for voice communication.....	103
4.4.6. Voice communication criteria definition .....	104
4.4.7. FRMCS call queueing on voice communication application level .....	105
4.5. Train control and monitoring system .....	106
4.5.1. Introduction.....	106
4.5.2. TCMS Train to Track Communication .....	106
5. Coordinating function for voice applications .....	107
6. FRMCS/GSM-R interworking .....	108
7. Annex A: REC Implementation Options .....	109
8. Annex B: Interoperability requirements in EU.....	110
8.1. Scope and Purpose .....	110
8.2. Definitions .....	110
8.3. List of MI Candidate clauses .....	111

## Table of figures and tables

Figure 1: FRMCS specifications .....	18
Figure 2: functional interface specification scope .....	20
Figure 3: OB <sub>app</sub> tight-coupled mode .....	24
Figure 4: entities involved in OB <sub>app</sub> TC mode end-to-end dialog .....	24
Figure 5: OB <sub>app</sub> loose-coupled mode .....	25
Figure 6: entities involved in OB <sub>app</sub> LC mode end-to-end dialog .....	25
Figure 7: TC mode using FRMCS Trackside Gateway .....	26
Figure 8: LC mode using FRMCS Trackside Gateway .....	27
Figure 9: Direct access mode .....	27
Figure 10: Session Start, H2H .....	33
Figure 11: Session Start, H2N .....	33
Figure 12: Session End, H2H .....	34
Figure 13: Session End, H2N .....	35
Figure 14: Local Registration request followed by MCX registration .....	37
Figure 15: IFSDT procedure without ongoing communication .....	51
Figure 16: handling of ATP-TS User responsibility handover .....	54
Figure 17: handover between ATP-TS Users in a same service domain .....	55
Figure 18: Nominal call flow for handover between ATP-TS Users in different service domain .....	58
Figure 19: Non-nominal call flow for handover between ATP-TS Users in different service domain .....	58
Figure 20: Addressing for PKI and KMS Session .....	59
Figure 21: Selected Initiating Area upon REC initiation .....	65
Figure 22: Addressed area corresponding to selected Initiating Area .....	65
Figure 23: Pre-requisites for REC call related operations .....	67
Figure 24: REC flow for mobile originating REC .....	68
Figure 25: REC flow for dispatcher originating REC .....	70
Figure 26: REC flow for adding User based on client movement .....	71
Figure 27: REC flow for removing User based on client movement .....	72
Figure 28: REC flow for adding a User based on evaluation of criteria .....	73
Figure 29: REC flow for removing a User based on evaluation of criteria .....	74
Figure 30: Flow for setup of REC alert .....	76
Figure 31: REC alert flow for adding a User based on client movement .....	78
Figure 32: REC alert flow for removing a User based on client movement .....	79
Figure 33: REC alert flow for adding a User based on evaluation of criteria .....	80
Figure 34: REC alert flow for removing a User based on evaluation of criteria .....	82
Figure 35: REC-voice communication flow for floor request .....	83
Figure 36: Driver to controller voice communication flow .....	90
Figure 37: Controller to driver voice communication flow .....	92
Figure 38: Multi-Train voice communication initiated by driver communication flow .....	94
Figure 39: Multi-Train voice communication initiated by controller communication flow .....	96
Figure 40: Controller-to-controller(s) voice communication using ad hoc group call flow .....	98
Figure 41: Adding a participant to an on-going ad-hoc group call .....	100
Figure 42: Pseudo-merging of two ongoing voice communications flow .....	102
Table 1: IP address parameters .....	32
Table 2: List of criteria for ad hoc group call and ad hoc emergency alert .....	85
Table 3: List of parameters used in FRMCS service server for call control functionality .....	86



Table 4: List of criteria for ad hoc group used for voice communications..... 105

# 1. Introduction

## 1.1. Purpose

- 1.1.1.1.1. This document is defining the end-to-end transactions flows required to achieve the functional requirements specified in [FRMCS FRS]. It specifies which telecommunication service primitives have to be used and how they have to be used to deliver FRMCS services to any Railway Application. (I)
- 1.1.1.1.2. This document only covers the communication based on the use of the 3GPP MC services, whatever the underlying transport network consist of. (I)
- 1.1.1.1.2i In this document, only the MC service layer requirements are explicitly specified. The potential requirements related to the IMS/SIP Core service layer are out of scope. (I)
- 1.1.1.1.3. It is important to understand that this specification is completing the other FRMCS specifications ([FRMCS FRS], [FRMCS SRS], [FRMCS FFFIS] and [FRMCS TOBA FRS]) and that it can't be used separately from those ones. (I)
- 1.1.1.1.4. The FRMCS FIS is part of the FRMCS specifications as depicted in Figure 1. (I)
- 1.1.1.1.5. The FRMCS URS and USE CASES documents are not part of the FRMCS normative specifications but were used as a basis for the writing of FRMCS specifications. (I)

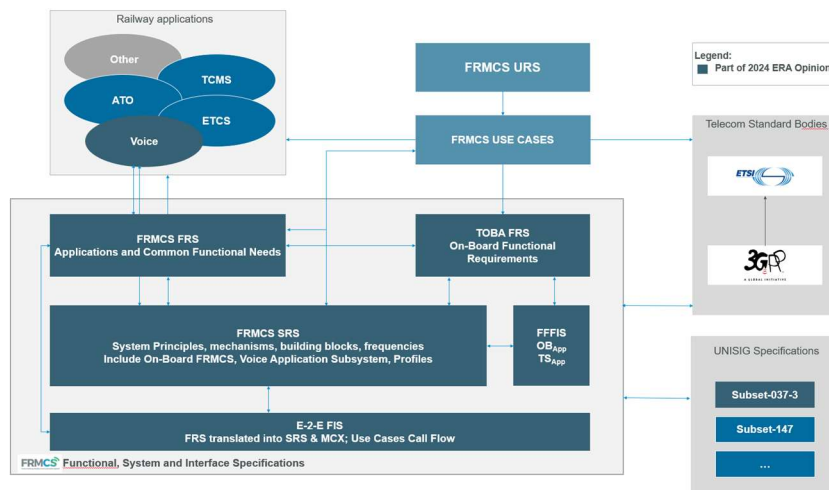

Figure 1: FRMCS specifications

## 1.2. Scope

- 1.2.1.1.1. In Figure 2, the elements coloured in blue represent the main scope of the FRMCS functional requirements specifications (see [FRMCS FRS] and [FRMCS TOBA FRS]). (I)
- 1.2.1.1.2. The functional requirements of several of the Railway Applications represented in Figure 2 are partially or totally out of

the FRMCS specifications scope but, at least, the way these have to request the services of the FRMCS System must be specified. (I)

- 1.2.1.1.3. In Figure 2, the continuous blue lines represent the scope of this FIS i.e. are representing the interfaces for which the service primitives and their corresponding parameters must be specified. (I)
- 1.2.1.1.4. This FIS only covers the interface requirements related to the Service Stratum and is valid whatever is the transport technology used to enable the telecommunication path beyond the On-Board FRMCS and beyond the FRMCS Trackside Gateway. (I)
- 1.2.1.1.5. Figure 2 intends to cover the communication between an onboard entity and a trackside entity but also between two (or more) trackside entities or two (or more) onboard entities. (I)
- 1.2.1.1.6. Some of the Railway Applications represented in Figure 2 deliver a communication function to a human user (e.g. VAS). The human user is the User. (I)
- 1.2.1.1.7. Some of the Railway Applications represented in Figure 2 act as a the User (e.g. ATP). (I)
- 1.2.1.1.8. Intentionally deleted.
- 1.2.1.1.9. Figure 2 is not intended to be exhaustive and is not covering all the FRMCS Applications specified in [FRMCS FRS]. (I)
- 1.2.1.1.10. Regarding the trackside VAS, the way to access the FRMCS could bypass the use of a FRMCS Trackside Gateway as depicted in the Figure 2. (I)
- 1.2.1.1.11. The present version of the document only covers the ATP requirements related to the European Train Control System (ETCS). (I)
- 1.2.1.1.12. The present version of the document only covers the requirements for ATO based on the European Train Control System (ETCS). (I)
- 1.2.1.1.13. The backward compatibility with GSM-R for ETCS application is not in the scope of the FRMCS specifications. This compatibility shall be enabled by a coordinating function specified in [SUBSET-037-1]. (I)

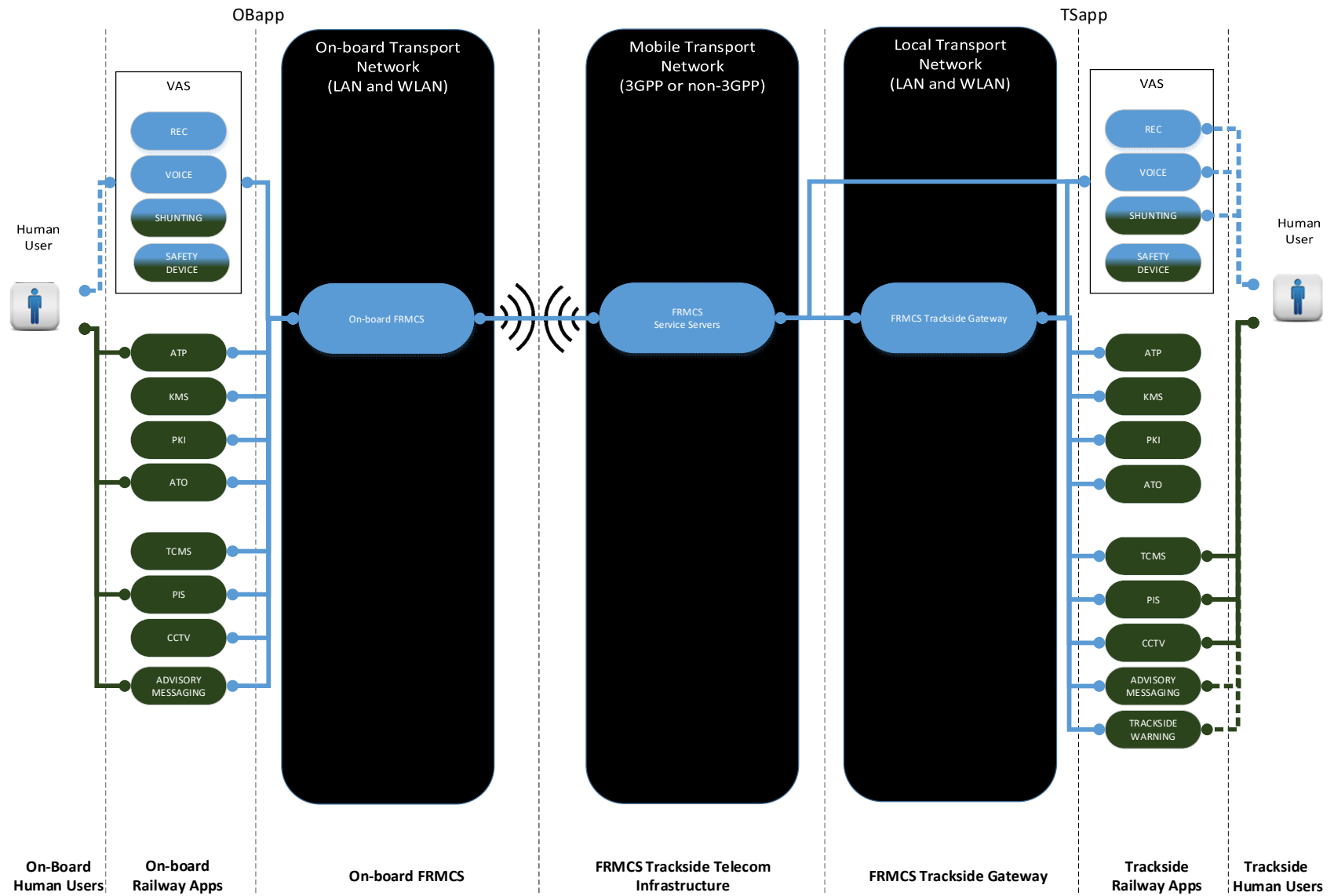

Figure 2: functional interface specification scope

## 1.3. Categorisation of the clauses

- 1.3.1.1.1. The statements made in the FIS specification are assigned to the following categories: (I)
- **Mandatory for the system** (indicated by '(M)' at the end of the clause). These requirements mean a condition set out in this specification that must be met without exception in order to deliver a system ensuring the fulfilment of essential functional and system needs, compliance to relevant standards and technical integration. The mandatory requirements are identified as sentences using the keyword "shall".
  - **Optional for the system** (indicated by '(O)' at the end of the clause). These requirements may be used based on the implementers' choice. When an optional requirement is selected, the related requirement(s) of this specification becomes mandatory for the system. The optional requirements are identified as sentences using the keyword "should".
  - **Information** (indicated by "(I)" at the end of the clause). These statements provide additional information to help the reader understanding a requirement.
- 1.3.1.1.1i When a requirement clause contains a bulleted list, the categorisation precedes the bulleted list indicating that the FRMCS system shall/should support all items in the list. (I)
- 1.3.1.1.1ii The following marking is applied to denote the applicability of clauses: (I)
- a) Indications (M), (O) and (I) are used for clauses within the scope of the V2 specification, which is the minimum set of requirements for validation;
  - b) Indications (M-V3), (O-V3) and (I-V3) are used for clauses within the scope of the V3 specification. The V3 series of specification are the target version to be included in the TSI, to allow migration from the GSM-R system to the FRMCS system (FRMCS 1st edition). The V3 clauses are to be considered for information for V2;
  - c) Indications (M-Vx), (O-Vx) and (I-Vx) are used for clauses for a later version of the specification. These clauses are kept in the specification for readability and consistency purposes;
  - d) Indications (M-V3), (O-V3), (I-V3) and (M-Vx), (O-Vx), (I-Vx) may also be used for sub bullets within a clause to identify a different applicability. In this case each bullet will be indicated individually.
- 1.3.1.1.2. Intentionally deleted.

## 1.4. FRMCS services access modes

### 1.4.1. Foreword

- 1.4.1.1.1. There are two main ways to access to the FRMCS services: (I)
- a) Direct access mode
  - b) Gateway access mode
- 1.4.1.1.2. A Railway Application using the direct access mode is an application which doesn't require the use of an On-Board FRMCS (for onboard application) or FRMCS Trackside Gateway (for trackside application) to access the FRMCS services. For example, an MCX-enabled controller system or controller device embedding the application and an MCX client is able to work in direct access mode. (I)
- 1.4.1.1.3. A Railway Application using the gateway access mode is an application which is accessing the FRMCS services through an On-Board FRMCS (for onboard application) or FRMCS Trackside Gateway (for trackside application). The communication between the Railway Application and the On-Board FRMCS or the FRMCS Trackside Gateway is performed through a local onboard/trackside transport network. The radio access is managed by the On-Board FRMCS which is responsible for supporting the communication services towards the onboard Railway Applications. (I)
- 1.4.1.1.4. The gateway access mode can be divided into two main categories: (I)
- a) An MCX client managed by the Railway Application (e.g. VAS ) is used to access the FRMCS services.
  - b) An MCX client managed by the On-Board FRMCS or FRMCS Trackside Gateway is used to provide access to the FRMCS services for the Railway Application (e.g. ATP).
- 1.4.1.1.5. A Railway Application from the category a) directly uses the service primitives specified by the 3GPP technical specifications related to Mission Critical Services (MCX). These service primitives are then relayed by the On-Board FRMCS or FRMCS Trackside Gateway. This way to access the FRMCS services is called tight-coupled mode (TC mode). (I)
- 1.4.1.1.6. A Railway Application from the category b) doesn't directly use the MC service primitives because the telecommunications technology independency is a strong requirement for this type of Railway Applications. This way to access the FRMCS services is called loose-coupled mode (LC mode). (I)
- 1.4.1.1.7. The specific API primitives to be used by the Railway Applications in LC mode are specified in [FRMCS FFFIS]. When required, the On-Board FRMCS or FRMCS Trackside Gateway is addressing the MC service primitives to the MC services

servers based on the API primitives received from the Railway Application. (I)

- 1.4.1.1.8. An implementation variant of the category b) is to use an MCX client managed by the On-Board FRMCS or FRMCS Trackside Gateway but through a third-party entity placed between the Railway Application and the On-Board FRMCS or FRMCS Trackside Gateway. However, the interface between the Railway Application and this entity is considered as out of the scope of the FRMCS specification and this variant is considered as covered by LC mode in this document. This variant of implementation is called super loose-coupled mode (SLC mode). Such a Railway Application is qualified as “not OB<sub>app</sub> aware” because it is not able to use API primitives specified in [FRMCS FFFIS]. (I)
- 1.4.1.1.9. It is possible to use different access modes (LC or TC mode) for the end points of a given Service Session. (I)
- 1.4.1.1.10. A mode bypassing the MC services is out of the scope of this document. (I)
- 1.4.1.1.11. The OB<sub>app</sub> and TS<sub>app</sub> interfaces accommodate different protocols levels for both TC and LC modes, see [FRMCS FFFIS] for details. (I)

## 1.4.2. OB<sub>app</sub> tight-coupled mode

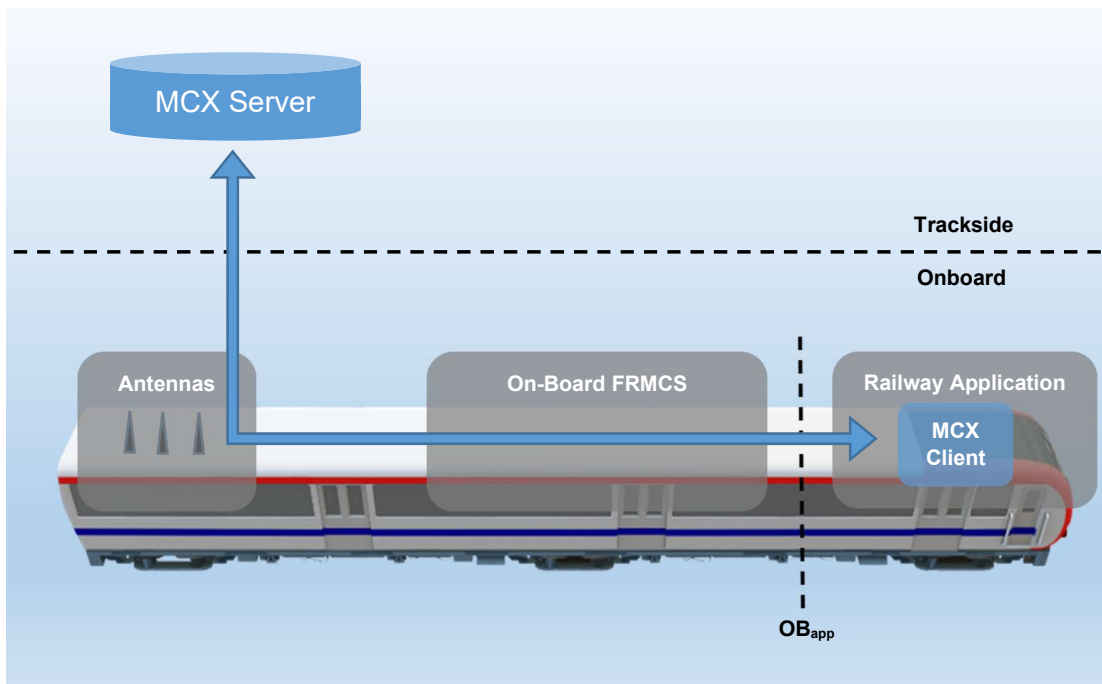

Figure 3: OB<sub>app</sub> tight-coupled mode

- 1.4.2.1.1. With the tight-coupled mode, the MCX requests sent from the onboard Railway Application entity towards the MCX Server are relayed by the On-Board FRMCS through its own mobile radio access devices (e.g. 3GPP UEs). The On-Board FRMCS is accessed by the Railway Application through a local transport network. (I)
- 1.4.2.1.2. In the case of a Railway Application working in the TC mode, the present FIS is (at least) defining the messages exchanged between the entities illustrated in the figure below. (I)

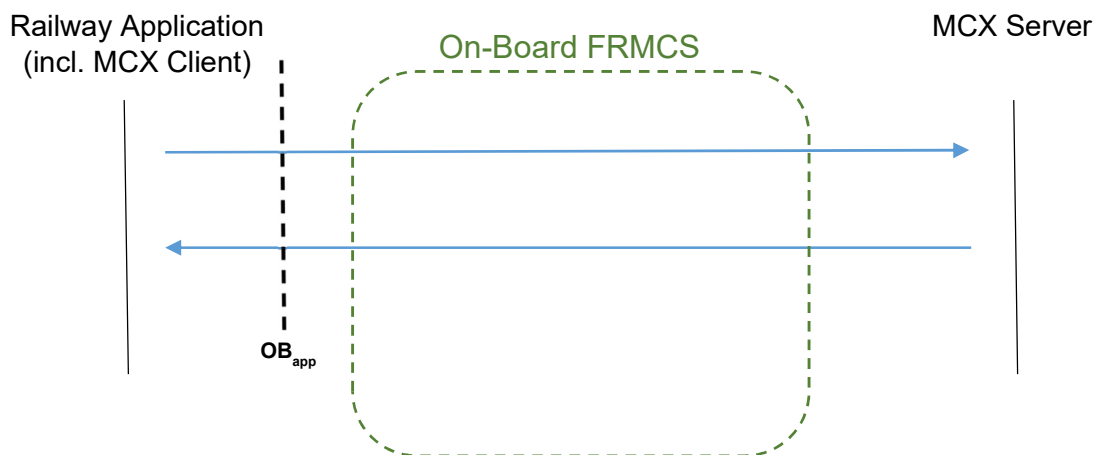

Figure 4: entities involved in OB<sub>app</sub> TC mode end-to-end dialog



### 1.4.3. OB<sub>app</sub> Loose-coupled mode

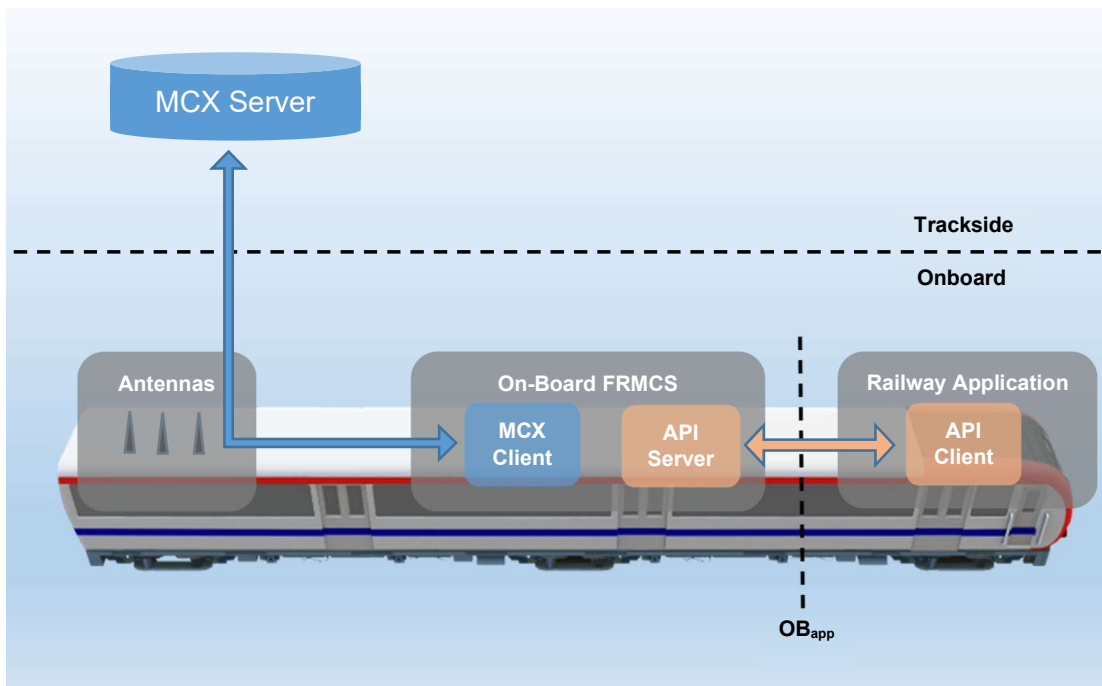

Figure 5: OB<sub>app</sub> loose-coupled mode

- 1.4.3.1.1. With the loose-coupled mode, to enable a FRMCS communication path, the onboard Railway Application uses a dedicated API to send requests towards the On-Board FRMCS through a local transport network. Then, the On-Board FRMCS uses its own MCX Clients and its own mobile radio devices (e.g. 3GPP UEs) in order to initiate the MCX primitives required to fulfil the requests of the Railway Application. (I)
- 1.4.3.1.2. In the case of a Railway Application working in the LC mode, the present FIS is defining the messages exchanged between the entities illustrated in the figure below while they are directly or indirectly related to an end-to-end MCX flow. (I)

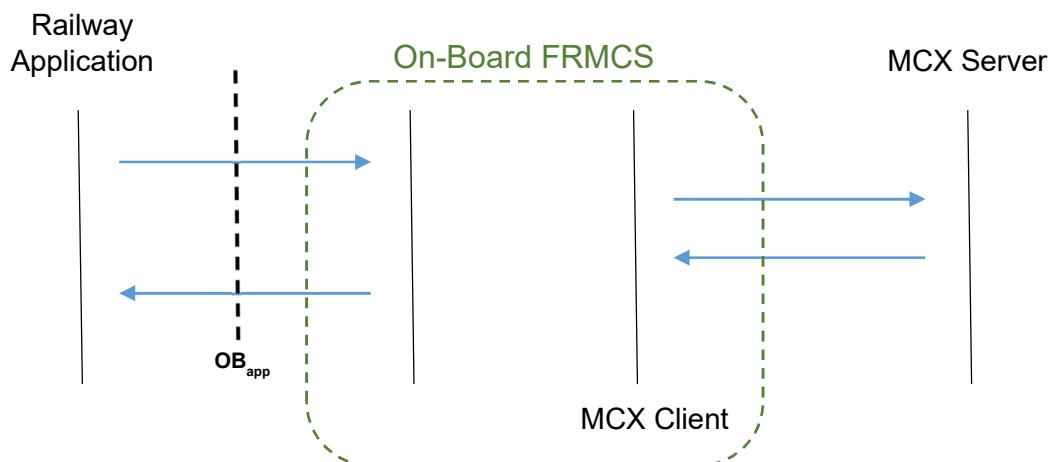

Figure 6: entities involved in OB<sub>app</sub> LC mode end-to-end dialog

#### 1.4.4. TS<sub>app</sub> Tight-coupled mode

- 1.4.4.1.1. For a tight-coupled Railway Application, a TS<sub>app</sub> interface – counterpart of OB<sub>app</sub> interface – between the FRMCS Trackside Gateway and the trackside Railway Application could be applicable. For interface specification see [FRMCS FFFIS] and for applicability see [FRMCS SRS]. (I)
- 1.4.4.1.2. As depicted in the Figure 7, with the tight-coupled mode, the MCX requests sent from the trackside Railway Application entity towards the MCX Server are relayed by an FRMCS Trackside Gateway. (I)

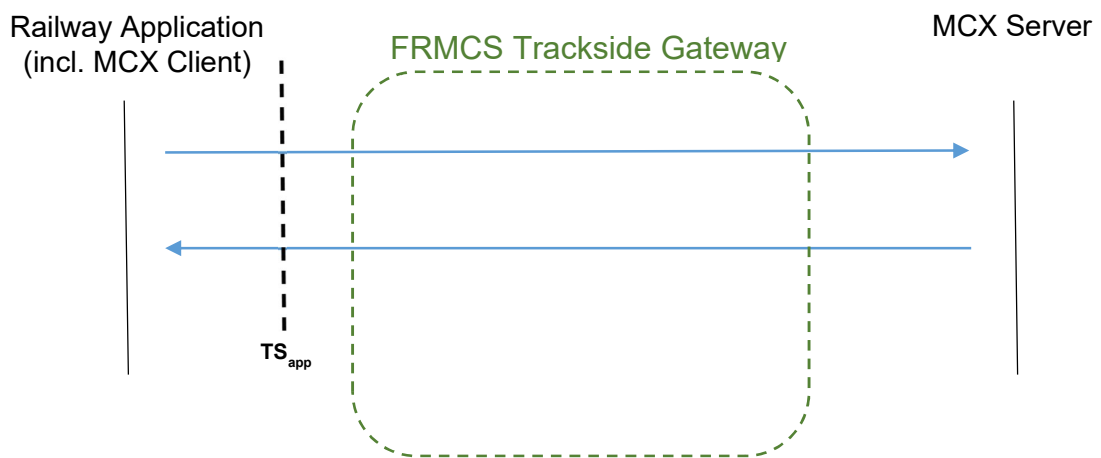

Figure 7: TC mode using FRMCS Trackside Gateway

#### 1.4.5. TS<sub>app</sub> Loose-coupled mode

- 1.4.5.1.1. For a loose-coupled Railway Application, The TS<sub>app</sub> interface – counterpart of OB<sub>app</sub> interface – between the FRMCS Trackside Gateway and the trackside Railway Application could be applicable. For interface specification see [FRMCS FFFIS] and for applicability see [FRMCS SRS]. (I)
- 1.4.5.1.2. As depicted in Figure 8, with the loose-coupled mode, the MCX requests sent from the trackside Railway Application entity towards the MCX Server are relayed by an FRMCS Trackside Gateway. (I)

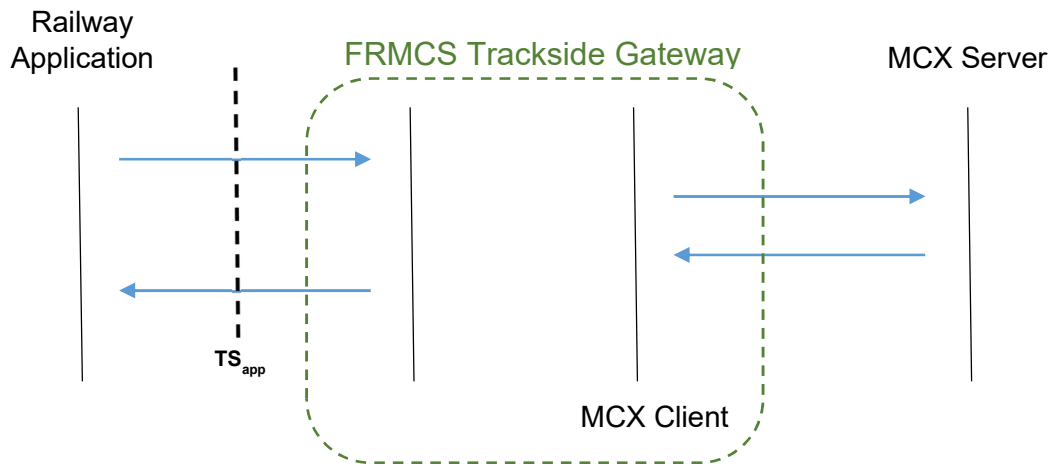

Figure 8: LC mode using FRMCS Trackside Gateway

### 1.4.6. Direct access mode

- 1.4.6.1.1. As depicted in Figure 9, the MCX requests sent from the trackside Railway Application entity towards the MCX Server are in direct access mode, hence bypassing the use of any FRMCS Trackside Gateway. (I)
- 1.4.6.1.2. The TS<sub>CTRL</sub> interface, which provides means for the controller application to connect towards the MCX Server, is an example of direct access mode as specified in [FRMCS SRS] §6.1.3.1.2. (I)

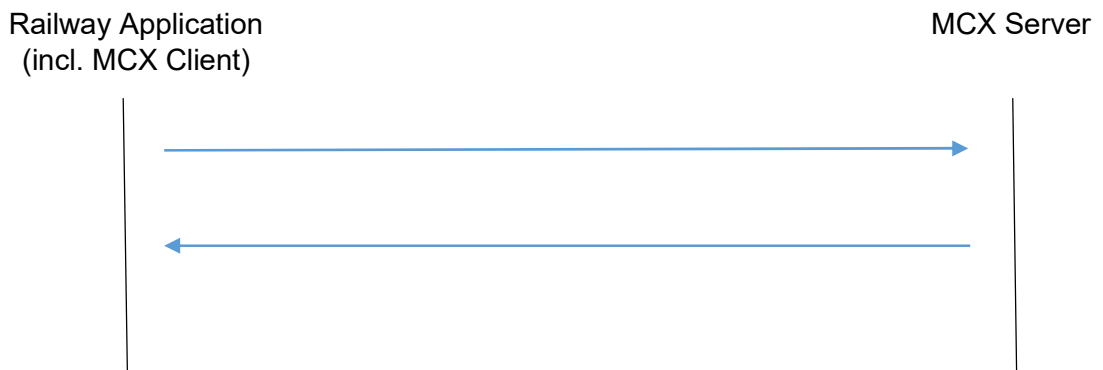

Figure 9: Direct access mode

### 1.5. Local Binding function

- 1.5.1.1.1. When the Railway Application is accessing the FRMCS services through an On-Board FRMCS or FRMCS Trackside gateway (in TC mode or LC mode), the Local Binding process is a prerequisite for the access of the Railway Application to the FRMCS services. (I)
- 1.5.1.1.2. For more details about the Local Binding process, see [FRMCS TOBA FRS] and [FRMCS FFFIS]. (I)

## 2. Service Session in gateway access mode

### 2.1. Service Session for LC

#### 2.1.1. Introduction

- 2.1.1.1.1. When the Railway Application is using the MCX Client embedded in an On-Board FRMCS or FRMCS Trackside Gateway to access the FRMCS services (LC mode), the way to request any FRMCS service is based on [FRMCS FFFIS]. (I)
- 2.1.1.1.2. Intentionally deleted.
- 2.1.1.1.3. The section 2.1 of this document provides the requirements related to the MC service primitives and API primitives having to be used when LC mode is applicable. (I)
- 2.1.1.1.4. The User Registration covered within section 2.1.2, could occur before or after Local Binding of the Railway Application, these two processes being specified as independent processes. This is left open for technical implementation. (I)

#### 2.1.2. User Registration request

- 2.1.2.1.1. The User Registration is a prerequisite for the use of the MC services. Upon successful User Registration and Local Binding, a User can request the initiation of a MCX communication and can be invited to participate in a MCX communication established by another User. (I)
- 2.1.2.1.2. The User Registration request shall be initiated : (M)
  - a) by the On-Board FRMCS for an onboard Railway Application in LC mode;
  - b) by the FRMCS Trackside Gateway for a trackside Railway Application.
- 2.1.2.1.2i More details about the rules that will be followed by On-Board FRMCS and FRMCS Trackside Gateway are available in [TS 103 765-3] and [TS 103 765-4] respectively. (I)
- 2.1.2.1.3. The User Registration process includes the MC User Authentication and the MC Service User service authorisation. (I)
- 2.1.2.1.4. The On-Board FRMCS shall provide the user name and password – required for User Registration – to the MCX Client. (M)
- 2.1.2.1.4i The FRMCS Trackside Gateway shall provide the user name and password – required for User Registration – to the MCX Client. (M)
- 2.1.2.1.5. Intentionally deleted.

- 2.1.2.1.6. The On-Board FRMCS shall associate the MC User and the corresponding MCX Client to the static identifier of a Railway Application based on configuration. (M)
- 2.1.2.1.6i The FRMCS Trackside Gateway shall associate the MC User and the corresponding MCX Client to the static identifier of a Railway Application based on configuration. (M)
- 2.1.2.1.7. Intentionally deleted.
- 2.1.2.1.8. During the User Registration process, the MCX Client of the On-Board FRMCS shall use the user name – as MC ID – and the password to perform the MC User Authentication in accordance with [TS 33.180]. (M)
- 2.1.2.1.8i During the User Registration process, the MCX Client of the FRMCS Trackside Gateway shall use the user name – as MC ID – and the password to perform the MC User Authentication in accordance with [TS 33.180]. (M)
- 2.1.2.1.9. During the User Registration process, the MCX Client of the On-Board FRMCS shall use for the authorization process the MC Service User identity (MC Service ID) received upon the MC User Authentication in accordance with [TS 33.180]. (M)
- 2.1.2.1.9i During the User Registration process, the MCX Client of the FRMCS Trackside Gateway shall use for the authorization process the MC Service User Identity (MC Service ID) received upon the user authentication in accordance with [TS 33.180]. (M)
- 2.1.2.1.10. The MCX Client shall authenticate the MC User to the MC service user's primary security domain. (M)
- 2.1.2.1.11. The MCX Client will always use the IdMS owned by its Home Service Domain (also called primary domain within MCX specifications) for authentication but this will not imply that the home MC service server has to be always used for Session establishment. (I)
- 2.1.2.1.11i The selection of the FRMCS Service Domain to use for MC User Service Authorisation is performed by the On-Board FRMCS based on predefined rules, see section 3.4. (I)
- 2.1.2.1.11ii The FRMCS Service Domain to use for MC User Service Authorisation is part of the FRMCS Trackside Gateway configuration. (I)
- 2.1.2.1.12. The MCX Client shall authenticate the MC User according to [TS 24.482] and to [TS 33.180] section 5.1.2. (M)
- 2.1.2.1.13. The user service (MCDATA) authorisation shall be performed according to [TS 33.180] section 5.1.3, where the SIP PUBLISH method according to [TS 33.180] section 5.1.3.2.3 shall be used. (M)

- 2.1.2.1.14. Depending on the type of the Railway Application, the service authorisation could be requested towards the Home Service Domain or could be requested towards the Visited Service Domain (e.g. for ATP use case). (I)
- 2.1.2.1.15. The MCX Client of the FRMCS Trackside Gateway should support activation of one Functional alias in own FRMCS Service Domain according to [TS 23.280] section 10.13.4. (O)
- 2.1.2.1.16. The MCX Client of the FRMCS Trackside Gateway should support activation of an Functional alias per adjacent FRMCS domain according to [TS 23.280] section 10.13.4 note 1. (O)
- 2.1.2.1.17. Activation of Functional alias in adjacent FRMCS domain(s) enable specific use cases in which the caller is outside the domain of the addressee, e.g., ATP border crossing use cases. (I)

### 2.1.3. Session Start request

- 2.1.3.1.1. The Session Start is the API primitive used to request the initiation of an MCX communication in LC mode (see [FRMCS FFFIS]). (I)
- 2.1.3.1.1i The present version of this document specifies only an onboard originated Session Start request in LC mode, which reflect the current use cases. (I)
- 2.1.3.1.2. Intentionally deleted.
- 2.1.3.1.2i In order to manage incoming Sessions and receive information of service availability a Railway Application in LC mode need to subscribe to the notification event stream of the OBapp/TSapp interface. See [FRMCS FFFIS] for details. (I)
- 2.1.3.1.2ii Intentionally deleted.
- 2.1.3.1.3. For a Railway Application in LC mode, a Session Start request shall be sent by the Railway Application to request the establishment of a Service Session. (M)
- 2.1.3.1.4. The On-Board FRMCS shall determine the destination address in SIP URI format based on the identity of the recipient provided by the Railway Application through the remote identifier parameter over the OB<sub>app</sub> interface (see [FRMCS FFFIS]). (M)
- 2.1.3.1.5. The On-Board FRMCS shall provide the destination address in SIP URI format to the MCX Client associated to the Railway Application requesting the Session Start. (M)
- 2.1.3.1.5i The FRMCS Trackside Gateway shall provide the destination address in SIP URI format to the MCX Client associated to the Railway Application requesting the Session Start. (M-Vx)
- 2.1.3.1.6. The destination address can represent the endpoint of the communication (H2H addressing) but can also represent a

- gateway entity providing access to a network (H2N addressing).  
(I)
- 2.1.3.1.7. The MCX Client of the On-Board FRMCS shall support the setup of the MCDATA Session based on a destination address provided as MC Service ID. (M)
  - 2.1.3.1.7i The MCX Client of the FRMCS Trackside Gateway shall support the setup of the MCDATA Session based on a destination address provided as MC Service ID. (M-Vx)
  - 2.1.3.1.8. The MCX Client of the On-Board FRMCS shall support the setup of the MCDATA Session based on a destination address provided as Functional alias. (M)
  - 2.1.3.1.8i The MCX Client of the FRMCS Trackside Gateway shall support the setup of the MCDATA Session based on a destination address provided as Functional alias. (M-Vx)
  - 2.1.3.1.9. The MCX Client associated with the Railway Application shall request the QoS and priority level based on the communication category as specified within [TS 103 765-1]. (M)
  - 2.1.3.1.10. If the Session setup is using a partner domain service, i.e. a Visited Service Domain, an inter-domain MC User service authorization according to [TS 33.180] section 5.1.4 shall be performed. (M)
  - 2.1.3.1.11. The MCX Client shall request the setup of an IP point-to-point connection using the MCDATA IP connectivity (IPcon) service as defined in [TS 23.282] section 7.14. (M)
  - 2.1.3.1.11i The incoming Session Start notification shall be used to invite a User to an MCX communication in LC mode. (M)
  - 2.1.3.1.11ii A Railway Application in LC mode may accept an incoming MCDATA IP connection setup using the 'incoming session request feature' specified in [FRMCS FFFIS]. (I)
  - 2.1.3.1.11iii After a successful Session setup in H2H mode, the IP address of the destination shall be provided to the originating Railway Application. (M)
  - 2.1.3.1.11iv After a successful Session setup in H2N mode, the IP address of a DNS available in the user plane shall be provided to the originating Railway Application. (M)
  - 2.1.3.1.11v Intentionally deleted.
  - 2.1.3.1.11vi Intentionally deleted.
  - 2.1.3.1.11vii Intentionally deleted.
  - 2.1.3.1.12. The message flow for H2H and H2N Session Start shall conform to flows depicted in Figure 10 and Figure 11 respectively. (M)

- 2.1.3.1.13. The step in the H2H case to resolve an optional functional alias is used especially to manage application specific addressing. For H2N there is currently no use case with application specific addressing. Therefore, is this step not included in the Figure 11. (I)
- 2.1.3.1.14. At least one IP address shall be provided in the <application-data> element of the SIP 200 (OK) response related to the point-to-point MCDATA transport service procedure. (M)
- 2.1.3.1.15. The information elements used for the IP addresses sent in the response shall conform to the following names: (M)

Information Element	Description
DataHostV4	The IPv4 address of the data host for host to host mode
DataHostV6	The IPv6 address of the data host for host to host mode
DNSserverV4	The IPv4 address of the DNS server for host to network mode
DNSserverV6	The IPv6 address of the DNS server for host to network mode

*Table 1: IP address parameters*

- 2.1.3.1.16. The IP addresses listed in Table 1 shall be encoded in JSON format (<https://www.json.org>). (M)
- 2.1.3.1.17. The encoding of the IP addresses listed in Table 1 shall conform to the following basic JSON format including the list of all parameters: (M)

```
{
  "FRMCS": {
    "IPconResponseIPAddr": {
      "DataHostV4": "",
      "DataHostV6": "",
      "DNSserverV4": "",
      "DNSServerV6": ""
    }
  }
}
```

- 2.1.3.1.18. The additional parameters "FRMCS" and "IPconResponseIPAddr" are technically not necessary, but allow a better structure of the message (e.g. other verticals like public safety could define "PS" instead of "FRMCS", and within FRMCS it is easier to define new messages at the level of "IPconResponseIPAddr"). (I)



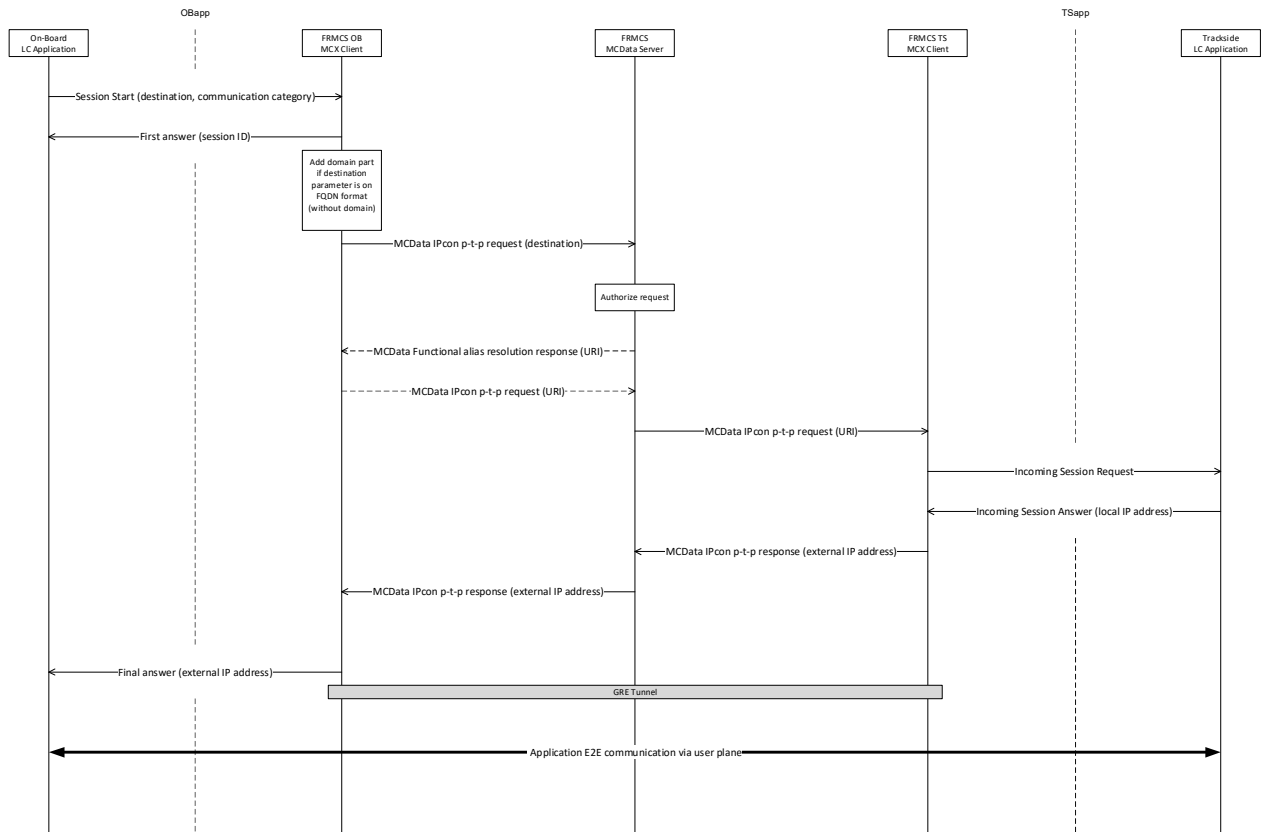

Figure 10: Session Start, H2H

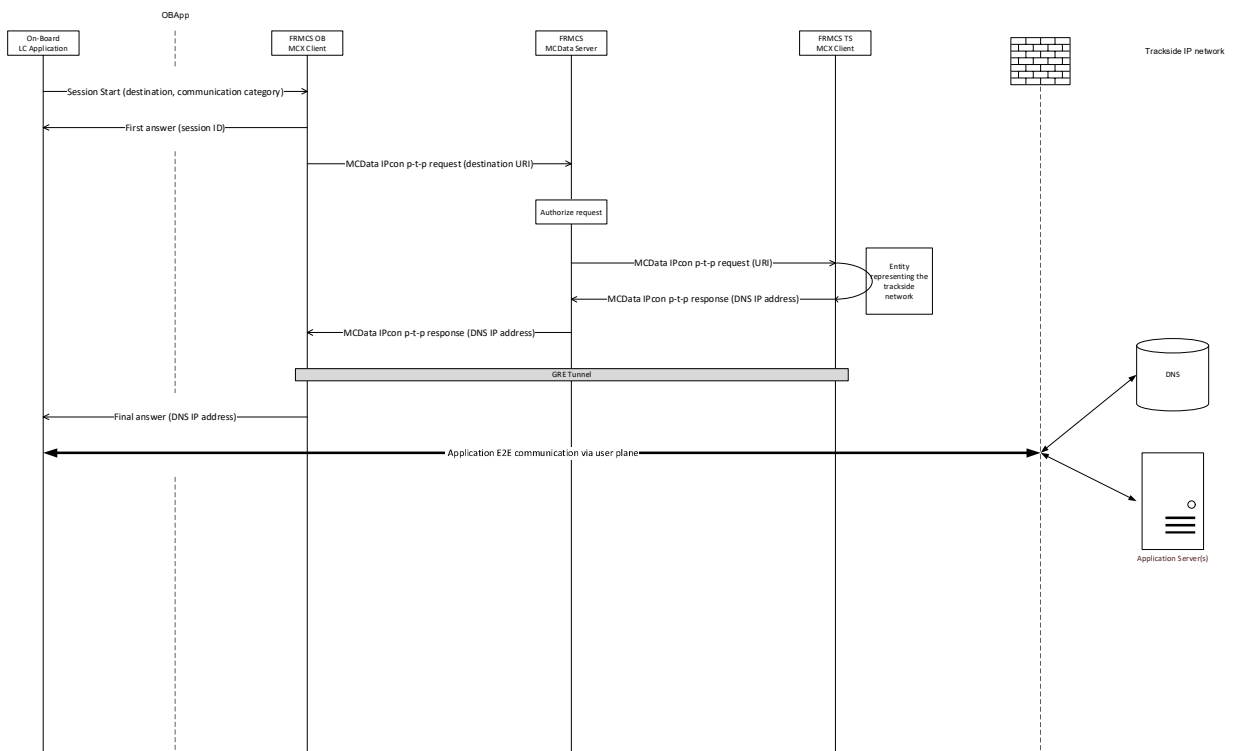

Figure 11: Session Start, H2N

## 2.1.4. Session End request

- 2.1.4.1.1. The Session End is the API primitive used to request the termination of a MCX communication in LC mode. (I)
- 2.1.4.1.2. For a Railway Application in LC mode, a Session End request shall be sent by the Railway Application to request the end of the Service Session. (M)
- 2.1.4.1.3. The MCX Client shall release the MCDATA IP connection using the communication release procedure defined in [TS 23.282] section 7.7. (M)
- 2.1.4.1.4. The message flow for H2H and H2N Session End shall conform to flows depicted in Figure 12 and Figure 13 respectively. (M)
- 2.1.4.1.5. The incoming session end notification depicted in Figure 12 corresponds to the Session Closure Notification specified in [FRMCS FFFIS]. (I)

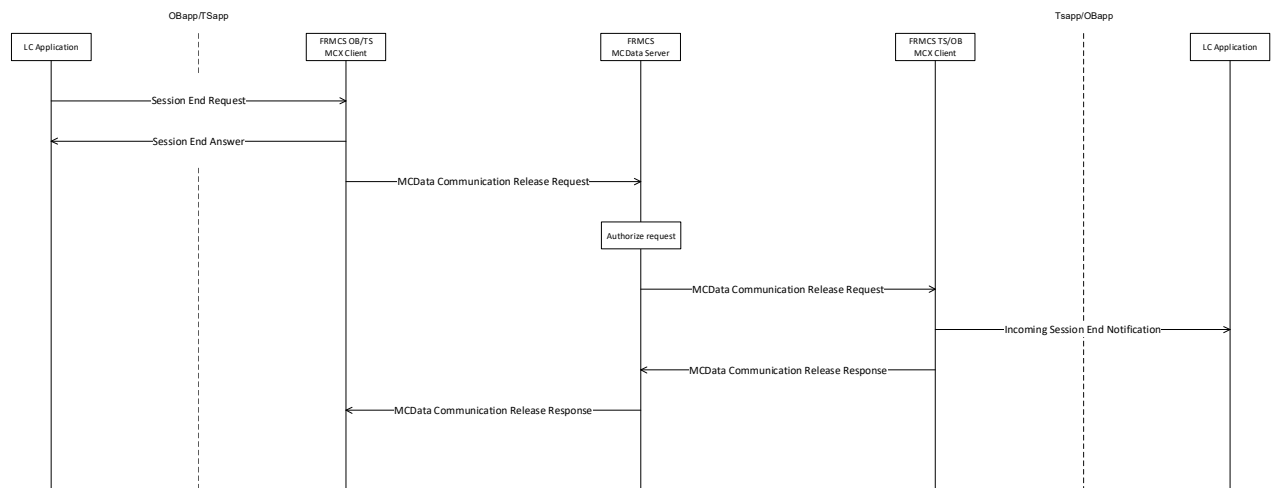

Figure 12: Session End, H2H

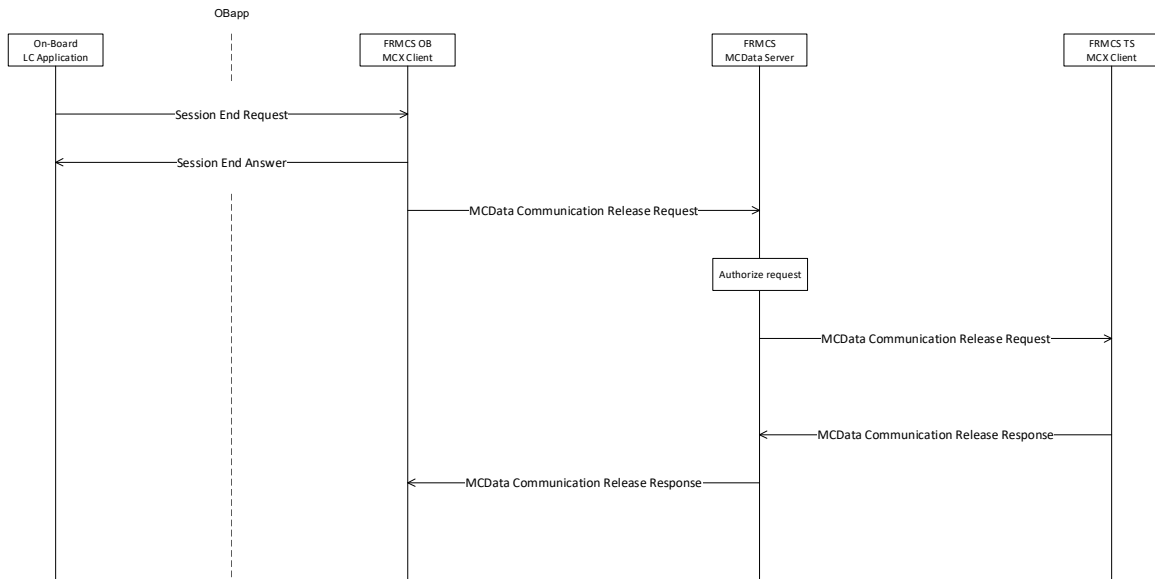

Figure 13. Session End, H2N

## 2.1.5. Incoming session start notification

- 2.1.5.1.1. Intentionally deleted.
- 2.1.5.1.2. Intentionally deleted.
- 2.1.5.1.3. Intentionally deleted.
- 2.1.5.1.4. Intentionally deleted.

## 2.2. Service Session for TC mode

### 2.2.1. Introduction

- 2.2.1.1.1. When the Railway Application is using its own dedicated MCX Client to access the FRMCS services (TC mode), the way to request any FRMCS service from that Railway Application will be solely based on 3GPP and ETSI specifications and further specified in the chapters 3 and 4. However, the Local Binding process is also a prerequisite for this mode and the Local Registration request procedure in accordance with [FRMCS FFFIS] is also applicable to TC mode. (I)

### 2.2.2. User Registration request

- 2.2.2.1.1. The User Registration request shall be initiated by the Railway Application. (M)
- 2.2.2.1.2. The User Registration process includes the MC User Authentication and the MC Service User service authorisation. (I)
- 2.2.2.1.3. The user name shall be provided by the Railway Application. (M)
- 2.2.2.1.4. The password associated with the user name shall be provided by the Railway Application. (M)
- 2.2.2.1.5. Intentionally deleted.
- 2.2.2.1.6. During the User Registration process, the Railway Application shall use the username as MC ID and the password to perform the MC User Authentication in accordance with [TS 33.180]. (M)
- 2.2.2.1.7. During the User Registration process, the Railway Application shall use for the authorization process the MC Service User Identity (MC Service ID) received upon the MC User Authentication in accordance with [TS 33.180]. (M)
- 2.2.2.1.8. The selection of the FRMCS Service Domain to use for authentication shall be performed by the Railway Application. (M)
- 2.2.2.1.8i Depending on the needs of the Railway Application it could be requested to use systematically only the IdMS of the Home Service Domain for authentication or to apply the migration procedure involving Home IdMS and the IdMS of the Visited Service Domain. (I)
- 2.2.2.1.9. The Railway Application shall authenticate the User according to [TS 24.482] and to [TS 33.180] section 5.1.2. (M)
- 2.2.2.1.10. The MC User Service Authorisation shall be performed according to [TS 33.180] section 5.1.3, where the SIP PUBLISH method according to [TS 33.180] section 5.1.3.2.3 shall be used. (M)

- 2.2.2.1.11. The selection of the FRMCS Service Domain from which the service must be delivered - and consequently on which the authorisation has to be processed – shall be performed by the Railway Application. (M)
- 2.2.2.1.12. The selection of the FRMCS Service Domain could be based on predefined rules and/or triggering events. (I)
- 2.2.2.1.13. A triggering event could be e.g. an input from the User or a message from a beacon reader. (I)
- 2.2.2.1.14. The selection of the FRMCS Service Domain from which the service must be delivered could imply the selection of a specific associated radio transport network by the On-Board FRMCS. E.g. it could be the case for a Railway Application under control of an Infrastructure Manager. However, this is out of the scope of this document. (I)
- 2.2.2.1.15. An overview of the User Registration flow is illustrated in Figure 14 below. (I)

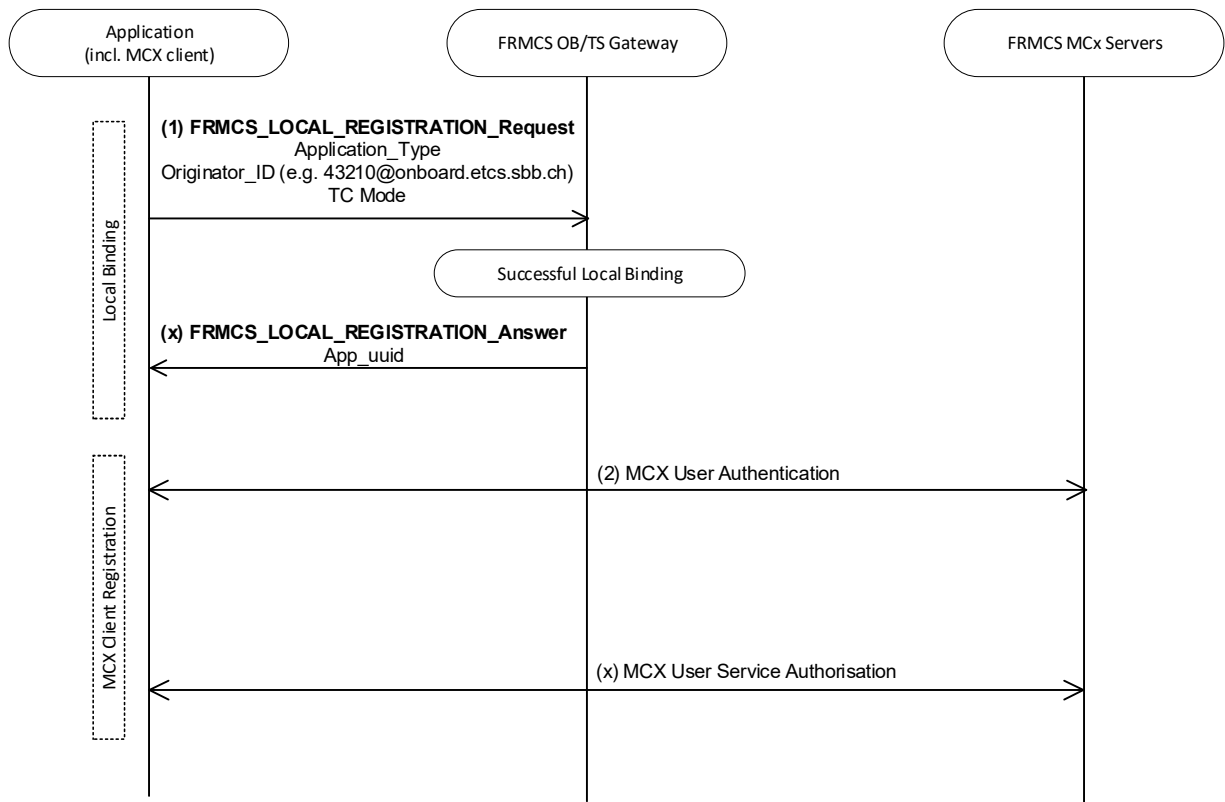

Figure 14: Local Registration request followed by MCX registration

## 3. Common functions requirements

### 3.1. Role management

#### 3.1.1. Introduction

- 3.1.1.1.1. This section of the document describes how the functional requirements related to the Role Management functions (see [FRMCS FRS]) are built on the basis of the MC services framework. (I)
- 3.1.1.1.2. As specified in [FRMCS FRS], the FRMCS System allows the addressing of a specific User among the Users associated to a specific User's equipment. (I)
- 3.1.1.1.3. As specified in [FRMCS FRS], when the User is logged into multiple User's equipment, the User is addressed through each of them. (I)
- 3.1.1.1.4. In order to achieve these addressing capabilities, each User is assigned with one or more identities. (I)
- 3.1.1.1.5. To have a User Identity is a prerequisite to use FRMCS services while Functional Identities are optional. (I)
- 3.1.1.1.6. The MC ID is used for MC User Authentication at the Identity Management Server and must be provided by the User, the Railway Application or the MCX Client. (I)
- 3.1.1.1.7. The MC Service ID is configured at the Identity Management Server and is returned to the client upon MC User Authentication. (I)
- 3.1.1.1.8. The MC Service ID is used for service authorization at the application server. (I)
- 3.1.1.1.9. One specific MC ID has up to three MC Service IDs mapped to it (one for each service), where the MC Service IDs can be identical or different from each other. (I)
- 3.1.1.1.10. One specific MC Service ID can activate multiple Functional Aliases, subject to MC User and MC Service configuration. (I)
- 3.1.1.1.11. The scope of a Functional Alias is restricted to a MC service (MCPTT, MCDATA, or MCVIDEO). (I)
- 3.1.1.1.12. A same value can be defined for Functional Aliases of different MC services, they are handled as different Functional Aliases by the MC services even if seen as the same identity from the User perspectives. (I)

## 3.1.2. User Identities

### 3.1.2.1. User login

- 3.1.2.1.1. In order to be able to address a communication to a User, this User needs at least to be assigned with a User Identity (see [FRMCS FRS]). (I)
- 3.1.2.1.2. The FRMCS System shall support the following MCX identities as User Identity in the communication addressing process: (M)
  - a) MC Service User Identity (MC Service ID)
  - b) Functional Alias
- 3.1.2.1.3. The User Registration as described in sections 2.1.2 and 2.2.2 is a prerequisite to get a MC Service ID. (I)
- 3.1.2.1.4. The User Registration and the Functional Alias activation as described in sections 3.1.3 are the prerequisites to get a Functional Alias. (I)
- 3.1.2.1.5. An example format of User Identity based on a MC Service ID is sarah.connor@mcptt.mnc010.mcc262.3gppnetwork.org. See [FRMCS SRS] for further details about MC Service ID. (I)
- 3.1.2.1.6. A single User Identity may be identical for all MC services (i.e. MCPTT ID, MCDATA ID and MCVIDEO ID are identical) or it may be specific for the MC services (i.e. MCPTT ID, MCDATA ID and MCVIDEO ID are different). (I)
- 3.1.2.1.7. An example format of User Identity based on a Functional Alias is sarah.connor@infrabel.be or cabradio1234@infrabel.be. (I)
- 3.1.2.1.8. A Functional Alias used as User Identity is further called User Alias. (I)
- 3.1.2.1.9. The User Alias shall be unique for a User. (M)
- 3.1.2.1.10. The User Alias shall include the following information elements: (M)
  - a) User information (e.g. sarah.connor, cabradio1234)
  - b) company information (company responsible for the user e.g. "infrabel")
  - c) country information (country where is located the IdMS e.g. "be")
- 3.1.2.1.11. A company information shall be univocally assigned to a corresponding MNC value. (M)
- 3.1.2.1.12. A country information shall be univocally assigned to a corresponding MCC value in accordance with [FRMCS SRS]. (M)
- 3.1.2.1.13. The format of the MC Service ID used to initiate a communication shall be the one specified within [FRMCS SRS]. (M)

- 3.1.2.1.14. The outcome of the login of a User into a FRMCS Service Domain is the assignment of one or more MC Service IDs with an associated User profile and optionally the assignment of one User Alias. (I)
- 3.1.2.1.15. The identities used in the underlying layers as the IMS identities are out scope of this document (I)

### 3.1.2.2. User Identities for ATP and ATO applications

- 3.1.2.2.1. The format of User Identity to use for ATP and ATO is specified in table section 11.4.5.3 within [FRMCS SRS]. (I)
- 3.1.2.2.2. Intentionally deleted.
- 3.1.2.2.3. Intentionally deleted.
- 3.1.2.2.4. Intentionally deleted.
- 3.1.2.2.5. Intentionally deleted.
- 3.1.2.2.6. Intentionally deleted.
- 3.1.2.2.7. Intentionally deleted.

### 3.1.2.3. User Identities for REC and VOICE communications

- 3.1.2.3.1. The User login as specified within [FRMCS FRS] should include the activation of the User Alias. (O)
- 3.1.2.3.1i The format of User Identity to use for REC and VOICE is specified in section 11.4.5.3 within [FRMCS SRS]. (I)
- 3.1.2.3.2. The FRMCS can be configured in way that allows a User to be assigned with a User Identity which is common for all MC services. This could be particularly useful for FRMCS Applications delivering communication services to human users (e.g. VAS). (I)



### 3.1.3. Functional identities

#### 3.1.3.1. General

- 3.1.3.1.1. Functional identities as specified in [FRMCS FRS] shall be implemented by using functional aliases as defined in [TS 23.280]. (M)

#### 3.1.3.2. Registration of functional identities

- 3.1.3.2.1. The procedures for registration of functional identities shall be implemented according to the procedures for activation of functional aliases defined in [TS 23.280]. (M)
- 3.1.3.2.2. The protocols for registration of functional identities used for voice communication shall be implemented according to the protocols for status change of functional aliases defined in [TS 24.379]. (M)
- 3.1.3.2.3. The protocols for registration of functional identities used for data communication shall be implemented according to the protocols for status change of functional aliases defined in [TS 24.282]. (M)

#### 3.1.3.3. De-registration of functional identities

- 3.1.3.3.1. The procedures for de-registration of functional identities shall be implemented according to the procedures for de-activation of functional aliases defined in [TS 23.280]. (M)
- 3.1.3.3.2. The protocols for de-registration of functional identities used for voice communication shall be implemented according to the protocols for status change of functional aliases defined in [TS 24.379]. (M)
- 3.1.3.3.3. The protocols for de-registration of functional identities used for data communication shall be implemented according to the protocols for status change of functional aliases defined in [TS 24.282]. (M)

#### 3.1.3.4. Interrogation of functional identities

- 3.1.3.4.1. The procedures for interrogation of functional identities shall be implemented according to the procedures for information requests for functional aliases defined in [TS 23.280]. (M)
- 3.1.3.4.2. The protocols for interrogation of functional identities used for voice communication shall be implemented according to the protocols for status determination of functional aliases defined in [TS 24.379]. (M)
- 3.1.3.4.3. The protocols for interrogation of functional identities used for data communication shall be implemented according to the protocols for status determination of functional aliases defined in [TS 24.282]. (M)

### 3.1.3.5. Transfer and hand-over of functional identities

- 3.1.3.5.1. The procedures for transfer and hand-over of functional identities shall be implemented according to the procedures for take-over of functional aliases defined in [TS 23.280]. (M-Vx)
- 3.1.3.5.2. The protocols for transfer and hand-over of functional identities used for voice communication shall be implemented according to the protocols for status change of functional aliases defined in [TS 24.379]. (M-Vx)
- 3.1.3.5.3. The protocols for transfer and hand-over of functional identities used for data communication shall be implemented according to the protocols for status change of functional aliases defined in [TS 24.282]. (M-Vx)

### 3.1.3.6. Automatic activation and de-activation of functional identities

- 3.1.3.6.1. Upon automatic activation and de-activation of functional identities handled by the role management and presence common function, the procedures defined for subscription/notifications of functional aliases in [TS 23.280] as well as the protocols for subscriptions/notifications defined in [TS 24.379] and [TS 24.282] shall be used to report the event to the MCX Client. (M-V3)
- 3.1.3.6.2. The role management and presence common function shall perform automatic activation and de-activation of functional identities using the procedures defined in section 3.1.3.2 and 3.1.3.3 of this document. (M-V3)

### 3.1.3.7. Usage of functional identities

- 3.1.3.7.1. The usage of functional identities to identify a calling User shall be implemented according to [TS 24.379] and [TS 24.282]. (M)
- 3.1.3.7.2. The usage of functional identities to address a called User shall be implemented according to [TS 24.379] and [TS 24.282]. (M)

## 3.2. Location services common function

### 3.2.1. Source of Location information

- 3.2.1.1.1. The positioning method used to locate a mobile MCX Client is using the following sources of the location information: (I)
  - a) GNSS
  - b) Serving Cell Identifier of the FRMCS Transport Domain
- 3.2.1.1.2. The notification service of the On-Board FRMCS – as defined in [FRMCS FFFIS] – forwards the serving cell identifier, GNSS and possibly other type of location information via OB<sub>app</sub> to the MCX Client of Railway Applications in TC mode. Then, the MCX Client reports this information to the MCX Server as specified in section 3.2.2. (I)
- 3.2.1.1.3. The location services specified in this document as mandatory for FRMCS System to locate a mobile MCX Client could be enhanced in a future version e.g. by the use of a railway specific positioning system. In such case, either the source of the location information is located onboard or is located Trackside. In the first case only, the method implies the convey of information through the location report mechanism and consequently leads to the specification of FIS requirements. (I)
- 3.2.1.1.4. Intentionally deleted. (I)

### 3.2.2. Location reporting

- 3.2.2.1.1. The Location information shall be sent via MCX Location Report messages from the MCX Clients of the Railway Applications in TC mode to the MCX Server as per [TS 23.280] and therein referenced specification. (M)
- 3.2.2.1.2. The update of the location position can use specific triggers. Triggers might be different based on Infrastructure Manager needs (e.g. time base trigger, cell change, distance based, ...), depending on different requirements (e.g. high-speed line, standard line, ...). See [FRMCS SRS] for definition of the triggers. (I)
- 3.2.2.1.3. The MCX based location reporting triggering methods as specified in [TS 23.280] are used as report triggering methods. (I)
- 3.2.2.1.4. Location reporting configuration is done by location management server to the location management client as per [TS 23.280]. (I)
- 3.2.2.1.4i Location reporting configuration shall support event triggered location reporting based on [TS 23.280] and the minimum set of location reporting triggers as defined in [FRMCS SRS]. (M-Vx)

- 3.2.2.1.4ii intentionally deleted. (I)
- 3.2.2.1.4iii When the Railway Application in TC mode is using the On-Board FRMCS Location reporting notification service as triggering event, the MCX location reporting configuration shall use “Event-triggered location reporting procedure” defined in [TS 23.280]. (M)
- 3.2.2.1.4iv A Railway Application in TC mode using the On-Board FRMCS Location reporting notification service shall apply the Location reporting configuration received from the MCX Server for the OB<sub>app</sub> notification service subscription configuration defined in [FRMCS FFFIS]. (M)
- 3.2.2.1.4v The location reporting trigger configuration can be determined by the MCX Server by evaluating the functional identity label after registration and also determined based on local policy. (I)
- 3.2.2.1.5. An authorized MCX Client (e.g. client used by a railway controller) shall be able to initiate event-triggered location reporting procedure from other clients based on [TS 23.280] “Client-triggered location reporting procedure”, “Client-triggered one-time location information report” or “Client-triggered periodic location information report”. (M)
- 3.2.2.1.6. In case of implementation specific (MCX external) trigger method (e.g. other train based positioning methods) the following procedure shall be used: (M-Vx)
- a) Location reporting configuration information can be part of the MC User profile or MC Service User profile or can be configured by the MCX Location server via mechanisms specified in [TS 23.280], where at least one of the methods shall apply. The exact definition of the reporting configuration is to be defined in future version of [FRMCS SRS].
  - b) Location reporting Configuration shall be event triggered as per MCX “Event-triggered location reporting procedure” in [TS 23.280] and based on implementation specific (MCX-external) event triggering the MCX Client to send a location report.
- 3.2.2.1.7. The date and time (timestamp) at which a location information measurement occurred shall be included in each location report with data formatting according to definition in [FRMCS SRS]. (M)
- 3.2.2.1.8. The location report shall include at least one of the following information elements : (M)
- a) GNSS information : Longitude, Latitude, Heading, Speed, Accuracy
  - b) Serving Cell ID of current FRMCS Transport Domain

- 3.2.2.1.8i The GNSS information included in the location report shall be used as follows to derive the Train Location Information as specified in [FRMCS SRS]: (M)
- a) The Train Geographic 2D Position shall be determined based on Longitude and Latitude
  - b) The Train Speed shall correspond to Speed
  - c) The Accuracy of the Train Geographic 2D Position and the Accuracy of the Train Speed shall be derived from Accuracy
  - d) The Train Direction shall be correspond to Heading
- 3.2.2.1.9. Intentionally deleted.
- 3.2.2.1.10. The location report shall support the location information related to the railway infrastructure (e.g. onboard odometry, balise ID...). (M-Vx)
- 3.2.2.1.10i The location report shall support the “Positioned Train Component” parameter. (M-Vx)
- 3.2.2.1.11. The Serving cell ID reporting shall be done with NCGI according to [TS 24.379]. (M)

## 3.3. Arbitration common function

### 3.3.1. Introduction

- 3.3.1.1.1. As specified in [FRMCS FRS], the FRMCS System allows arbitration between communications competing for the attention of the User through visible and audible indication. (I)
- 3.3.1.1.2. As specified in [FRMCS FRS], the arbitration common function supports to prioritise between competing voice and data communications on the human user device in order to ensure that the User is always involved in the most relevant communication based on his current operational role. (I)
- 3.3.1.1.3. As specified in [FRMCS FRS], arbitration common function also saves the human user from interacting with the HMI in order to keep the attention on the railway operations when required. (I)
- 3.3.1.1.4. In order to achieve these arbitration capabilities, each FRMCS Application is either univocally identified or is at least assigned with one application category. (I)
- 3.3.1.1.5. Same application category can be assigned to different FRMCS Applications. (I)
- 3.3.1.1.6. This section of the document describes how the User's Requested Priority is used to convey the Application Category (see also [FRMCS FRS]) on the basis of the MC services framework. (I)

### 3.3.2. General

- 3.3.2.1.1. The MCX Client shall include the Requested Priority parameter as defined in [TS 23.280] in the Service Session request. (M-V3)
- 3.3.2.1.2. Application category as specified in [FRMCS FRS] shall be based on an implementation using the Requested Priority as defined in [TS 23.379] and [TS 23.282]. (M-V3)
- 3.3.2.1.3. The Requested Priority information element shall be sent within MCX messages from the clients to the MCX Server and from MCX Server to MCX Server as per [TS 23.379] and therein referenced specification. (M-V3)
- 3.3.2.1.4. In TC mode, the Railway Application shall set the User Requested Priority value which includes the Application Category (e.g. VAS will provide a different value for REC alert as for Multi-trains communication). (M-V3)
- 3.3.2.1.5. In LC mode the On-Board FRMCS shall set the User Requested Priority as specified within [FRMCS SRS] (depending on the application category and/or communication category received from the LC application e.g. ATP). (M-V3)

[Editor's Note1] *The use of the Requested Priority in the framework of an LC Railway Application still require further assessment.*

- 3.3.2.1.6. The MCX Client shall use the User Requested Priority value to set the Requested Priority to be sent towards MCX Server. (M-V3)
- 3.3.2.1.7. The MCX Server shall evaluate the received User Requested Priority value and if it is inconsistent with the rules defined by MCX Server, then the server shall be able to modify it and use the modified value for Arbitration. (M-V3)
- 3.3.2.1.8. The target TC Railway Application is considering the received User Requested Priority value in the arbitration common function decision. (I)
- 3.3.2.1.9. The MCX Server shall evaluate the received User Requested Priority value and if it is inconsistent with the value defined by MCX Server, then the server is able to modify it and use the modified value for QoS and priority. (M-V3)

[Editor's Note2] *The use of the Requested Priority in the framework of QoS & Priority still require further assessment.*

- 3.3.2.1.10. If the MCX Server shall modify the User Requested Priority, then MCX Server shall send a notification with the modified User Requested Priority value to the originating MCX Client. (M-V3)

[Editor's Note3] *The need for this notification still require further assessment and could depend on the decision regarding the use of Requested Priority in the framework of QoS & Priority.*

- 3.3.2.1.11. The MCX Server shall send the received or modified User Requested Priority to all target MCX Clients being involved in the communication. (M-V3)

[Editor's Note4] *The sending of User Requested Priority to target MCX Clients is not available yet in 3GPP Rel18. Arbitration as specified in this version requires further specification at 3GPP level to be achieved.*

- 3.3.2.1.12. The table which defines the behaviour of the arbitration common function is specified in Appendix I of [FRMCS FRS]. (I)
- 3.3.2.1.13. The User Requested Priority value shall be a 6 digits value starting with non-zero digit. (M-V3)
- 3.3.2.1.14. The User Requested Priority value shall have the format [AC][AID][AP] where: (M-V3)
- [AC]: [100 – 999] (e.g. REC, Driver-to-Controller,...)
  - [AID]: [0 - 9] (e.g. RECalert, RECvoice, Driver-to-PC,...)
  - [AP]: [00 - 99]

- [AC] = Application Category
- [AID] = Application ID
- [AP] = Application Priority

## 3.4. Inter-FRMCS-Service-Domain Transition

### 3.4.1. Introduction

- 3.4.1.1.1. This section describes the Inter-FRMCS-Service-Domain Transition (IFSDT) procedure for a Railway Application having no ongoing communication Session at the time of the transition. The cases where a communication Session is ongoing at the time of the transition are covered in sections related to the concerned FRMCS Applications (see chapter 4). (I)
- 3.4.1.1.2. The IFSDT occurs when a train crosses the boundary from Serving FRMCS Service Domain (Serving FSD) towards Target FRMCS Service Domain (Target FSD) as defined in [FRMCS SRS]. (I)
- 3.4.1.1.3. Both FRMCS Service Domains involved in this procedure could be different from the Home FRMCS Service Domain. (I)
- 3.4.1.1.4. The trigger for network transition (NTT) initiates an action in the transport stratum. This action consists of the establishment of a transport path from an OB Radio Module (commonly used by all Railway Applications) to the Target FRMCS Transport Domain to carry the MC signalling of multiple OB MCX Clients. (I)
- 3.4.1.1.5. The LC Railway Applications are divided into four categories (Type I, Type II, Type III and Type IV) with respect to their behaviour during IFSDT, as defined in the chapter 10 of [FRMCS SRS]. (I)

[Editor's Note5] *Only Type I (IM interoperable applications, e.g., ATP) and Type IV (RU non-interoperable application, e.g., TCMS) are in the scope of this version of the document.*

- 3.4.1.1.6. For an LC Railway Application of Type IV, the MC User is always served by the Home FSD. Therefore, for such applications, IFSDT is not performed. There is only the need for a transport path (e.g., 5G PDU session) into the Home FRMCS Transport Domain for carrying the MC signalling to the Home FSD. (I)
- 3.4.1.1.7. In the following, for LC Railway Application, only Type I is considered in IFSDT procedure. (I)

### 3.4.2. Context

- 3.4.2.1.1. The following paragraphs explain the context at the starting point of the IFSDT procedure: (I)



- There is no ongoing communication Session in Serving FRMCS Service Domain for the concerned Railway Application.
- For TC Railway Application,
  - a) the MC User Identity TC MC ID is authenticated and obtained Token(s) for being served in Home FSD and Serving FSD (TC MCX ID H and TC MCX ID S, respectively). If Serving FSD is the Home FSD, TC MCX ID S is equal to TC MCX ID H.
  - b) The TC MCX ID S is authorized in Serving FSD. If Serving FSD is not the Home FSD, this last step includes the migration procedure ([TS 23.280] §10.6.3.3.1) as well.
  - c) Depending on the Railway Application, one or multiple FAs are also activated in Serving FSD (for the sake of simplicity this is not shown in the Figure 15).
- For LC Railway Application of Type I,
  - a) the MC User Identity LC MC ID is authenticated and obtained a Token(s) for being served in Home FSD and Serving FSD (LC MCX ID H and LC MCX ID S, respectively). If Serving FSD is the Home FSD, LC MCX ID S is equal to LC MCX ID H.
  - b) The LC MCX ID S is authorized in Serving FSD. If Serving FSD is not the Home FSD, this last step includes the migration procedure ([TS 23.280] §10.6.3.3.1) as well.
  - c) Depending on the Railway Application, one or multiple FAs are also activated in Serving FSD (for the sake of simplicity this is not shown in the figure).
- Network Transition Trigger (NTT, see [FRMCS SRS] §10.1.2) is received at OB FRMCS.
- A transport path (e.g., 5G PDU session) is established into the Target FRMCS Transport Domain which allows MC signaling with the MCX Servers at Target FRMCS Service Domain.

### 3.4.3. Inter FRMCS Service Domain Transition (IFSDT) Procedure

3.4.3.1.1. For a locally bound TC Railway Application (see Local Binding definition), the following steps shall be applicable (Figure 15):  
(M)

- 1) OB FRMCS shall notify the TC Railway Application of the availability of Target FTD. The notification message includes the reason set to “nwTransition” and the FRMCS Domain set to the PLMN of Target FTD [FRMCS FFFIS].

[Editor's Note6] *It is assumed that within TC\_MCX\_Client there is a mapping between this PLMN and a set of access information (MCX Servers' URI) of the Target FSD.*

- 2) The IdM Client within TC Railway Application shall obtain a Token (i.e., TC MCX ID T in the figure) for migrating to Target FSD as specified in [TS 33.180].

Note: This step requires the two following interactions “in sequence” (see [TS 33.180], Annex c.2):

- I. Interaction with the IdM Server of Home FRMCS Service Domain,
- II. Interaction with the IdM Server of the Target FRMCS Service Domain.

The establishment of transport path(s) needs to satisfy such in sequence interactions (i.e., the precondition 3 in the figure might occur between these two interactions).

- 3) TC\_MCX\_Client shall use this new service identity, namely TC MCX ID T, to initiate the migration procedure ([TS 23.280] §10.6.3.3.1).
- 3.4.3.1.2. At the completion of the three steps defined in §3.4.3.1.1, the TC MCX ID T is ready to get involved in incoming and outgoing communication Sessions. (I)
  - 3.4.3.1.3. The activation of a set of FAs which are mandatory for the concerned TC is out of the scope of this procedure and is directly handled by the TC Railway Application. It is assumed that the User information part of § 3.1.2.1.10 remains the same and the rest is modified according to the FSD. (I)
  - 3.4.3.1.4. For a locally bound LC Railway Application of Type I, the following steps shall be applicable (Figure 15): (M)
    - 1) The IdM Client within OB FRMCS shall obtain a Token (i.e., LC MCX ID T in the figure) for migrating to Target FSD.
    - 2) LC\_MCX\_Client shall use this new service identity, namely TC MCX ID T, to initiate the migration procedure ([TS 23.280] §10.6.3.3.1).
    - 3) Upon the successful completion of the previous step, the OB FRMCS shall notify the LC Railway Application of reaching the “FSD available” state for that application. The reason of notification is set to “nwTransiton” as defined in [FRMCS FFFIS].
  - 3.4.3.1.5. At the completion of the three steps defined in §3.4.3.1.4, the LC MCX ID T is ready to get involved in outgoing communication Sessions. (I)

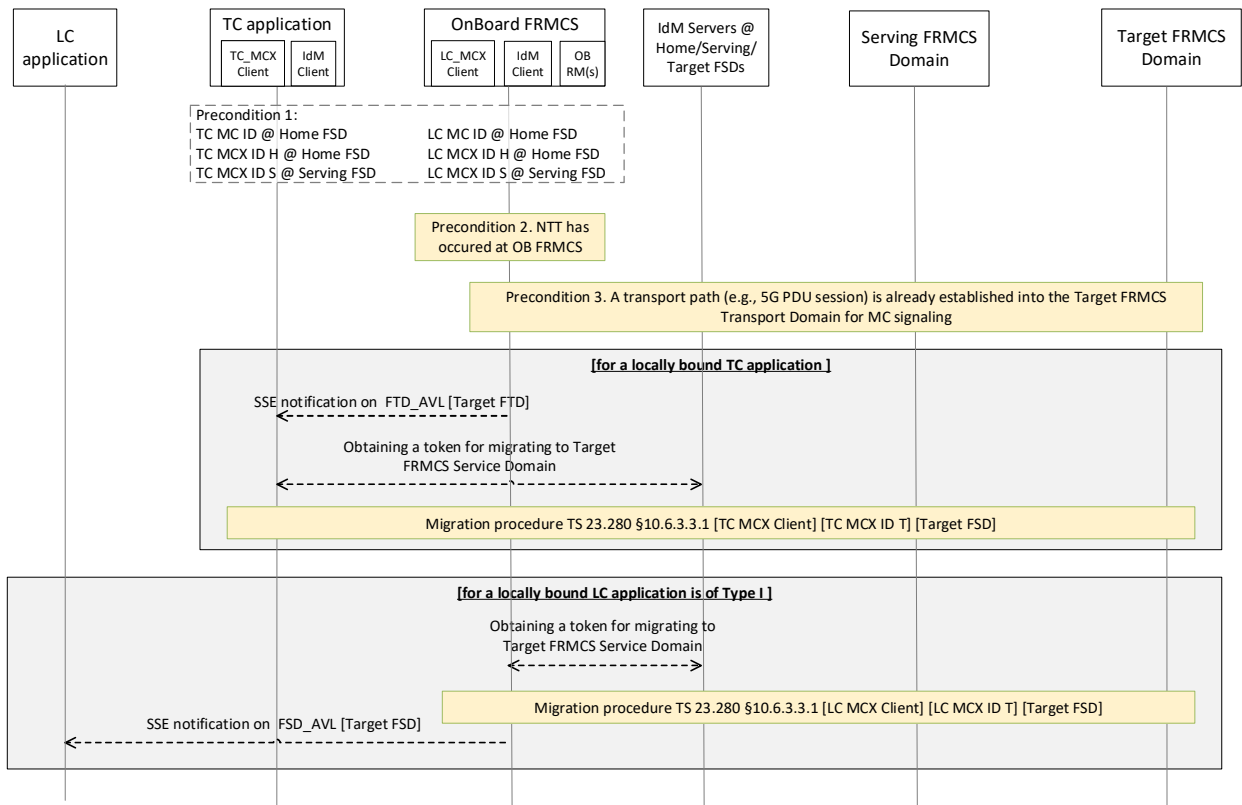

Figure 15. IFSDT procedure without ongoing communication

## 4. FRMCS Applications requirements

### 4.1. Automatic train protection

#### 4.1.1. Introduction

- 4.1.1.1.1. Intentionally deleted. (I)
- 4.1.1.1.2. Intentionally deleted. (I)
- 4.1.1.1.3. There are several types of data communications related to the ATP application, (I)
  - a) between onboard entity and trackside entity, enabling the automatic train protection,
  - b) between two trackside entities, enabling the responsibility handover mechanism required for the automatic train protection,
  - c) management and verification of security certificates for end-to-end communication (PKI),
  - d) online management of safety keys (KMS).
- 4.1.1.1.4. Type a) is specified below using the loose-coupled interface mode and H2H addressing mode. (I)
- 4.1.1.1.5. Type b) is usually a permanently connected link in the fixed PDN. The communication protocol is specified in [SUBSET-098]. (I)
- 4.1.1.1.6. Type c) and d) specified by section 4.1.7 are using the loose-coupled interface mode in H2N addressing mode. (I)

#### 4.1.2. ATP User Registration

- 4.1.2.1.1. The MCX Client associated to an ATP application (Onboard or Trackside) shall be registered to FRMCS Service Domain in accordance with the sections 2.1.2 and 3.1.2.2 of this document. (M)
- 4.1.2.1.2. A Functional Alias shall be activated by the MC client associated to the ATP trackside application in the home FRMCS domain in accordance with the requirements specified by section 2.1.2 of this document. (M)
- 4.1.2.1.3. A Functional Alias should be activated by the MC client associated to the ATP trackside application in adjacent FRMCS domain(s) in accordance with the requirements specified by section 2.1.2 of this document. (O)
- 4.1.2.1.4. Activation of an Functional alias in an adjacent FRMCS domain enable ATP border crossing for which the MC Service User associated to the Onboard ATP application is located outside the

FRMCS domain of the MC User associated to Trackside ATP application. (I)

- 4.1.2.1.5. The format of the Functional alias shall be a SIP URI using the FQDN according to [SUBSET-037-3] as user part. (M)

#### 4.1.3. Use of FRMCS location services

- 4.1.3.1.1. The location information available from FRMCS is used neither for ATP application internal purpose nor for routing of the ATP communication. (I)

#### 4.1.4. QoS and priority

- 4.1.4.1.1. Intentionally deleted. (I)
- 4.1.4.1.2. The QoS and priority shall be managed according to requirements specified within section 2.1.3 and to requirements specified in [FRMCS SRS] regarding the QoS level to use. (M)

#### 4.1.5. Handling of an ATP Session

- 4.1.5.1.1. The handling of an ATP Session covers, (I)
  - a) Setup of an end-to-end IP communication between the onboard ATP entity and the trackside ATP entity via the FRMCS System.
  - b) Release of the communication.
- 4.1.5.1.2. The setup of an end-to-end IP communication is initiated by the onboard entity. (I)
- 4.1.5.1.3. The release of an end-to-end IP communication is initiated by the onboard entity or by the trackside entity. (I)

##### 4.1.5.2. Session Start

- 4.1.5.2.1. The MCX Client associated to Onboard ATP (ATP-OB) application shall initiate a Session in accordance with the requirements specified in section 2.1.3. (M)
- 4.1.5.2.2. The remote identifier (identity of the recipient) shall comply to the remote address in FQDN format specified in [SUBSET-037-3]. (M)

##### 4.1.5.3. Session End

- 4.1.5.3.1. The FRMCS system shall support the ATP application to end a Session in accordance with the requirements specified in section 2.1.4. (M)

## 4.1.6. Handling of ATP-TS User responsibility handover

### 4.1.6.1. Introduction

- 4.1.6.1.1. The responsibility handover from an ATP-TS to another ATP-TS relies on the Session Start and Session End procedures described in section 4.1.5. (I)
- 4.1.6.1.2. The ATP-TS User responsibility handover process consists of the three following steps: (I)
- Handover preparation: the ATP-OB application having an active Session with the current responsible ATP-TS application (RBC) shall send a Session Start request to the future responsible ATP-TS.
  - Handover: the ATP-TS application reports the ATP-TS handover to ATP-OB application. The second Session becomes the active one.
  - Handover closing: the ATP-OB application shall send a Session End request for the initial Session.

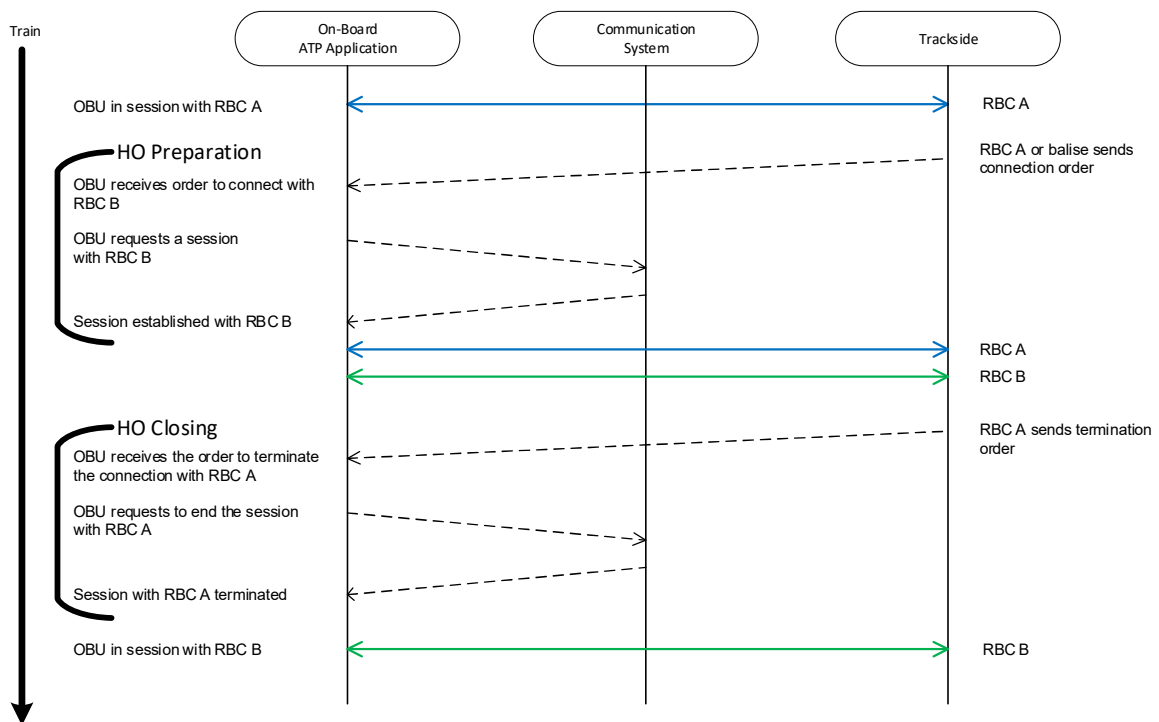

Figure 16: handling of ATP-TS User responsibility handover

#### 4.1.6.2. Handover between ATP-TS Users in a same service domain

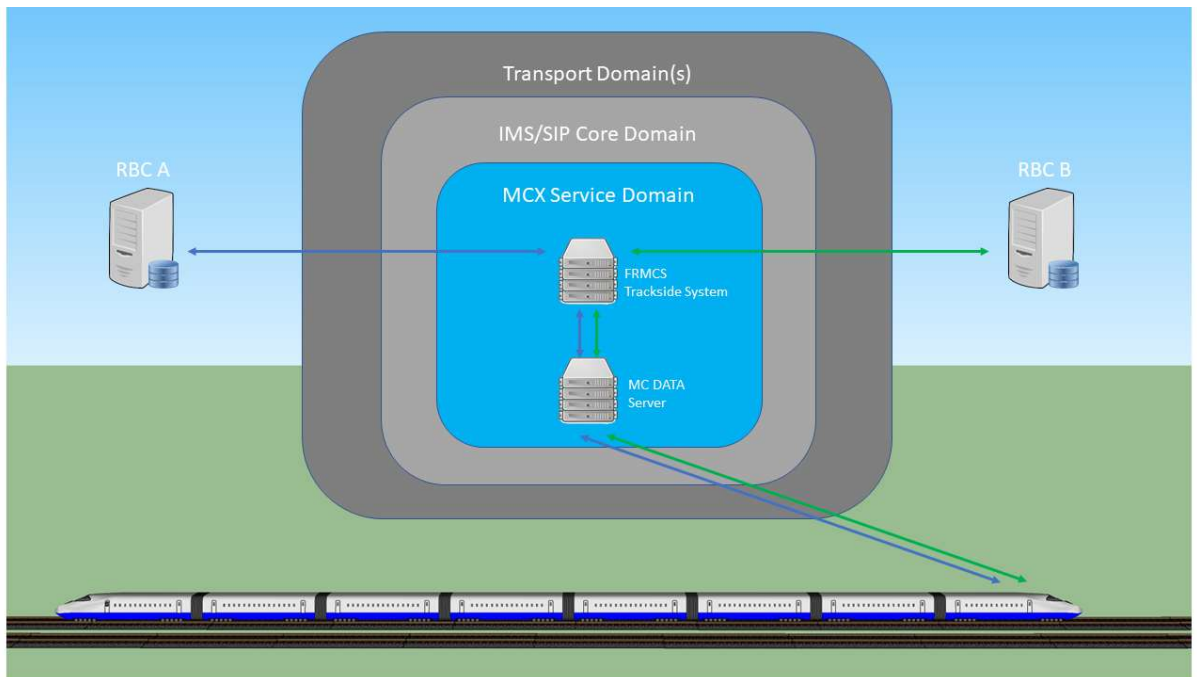

Figure 17: handover between ATP-TS Users in a same service domain

- 4.1.6.2.1. Figure 17 is intentionally representing only the trackside infrastructure but the different transport and services layers are also applicable onboard. (I)
- 4.1.6.2.2. In order to perform the handover preparation, the MCX Client handling the initial Session shall request the setup of an MCDATA IPcon Service Session as specified in section 2.1.3 by using the same serving MCX Domain as the one used for initial Session. (M)
- 4.1.6.2.3. In order to perform the handover closing, the MCX Client shall request the release of the MCDATA IPcon Service Session as specified in section 2.1.4. (M)

#### 4.1.6.3. Handover between ATP-TS Users in different service domains

##### Introduction

- 4.1.6.3.1. This section describes the Inter-FRMCS-Service-Domain Transition (IFSDT) procedure for ATP, when a train crosses the boundary from Serving FRMCS Service Domain (Serving FSD) towards Target FRMCS Service Domain (Target FSD) as defined in [FRMCS SRS]. (I)
- 4.1.6.3.2. Both FRMCS Service Domains involved in this procedure could be different from the Home FRMCS Service Domain. (I)
- 4.1.6.3.3. The trigger for network transition (NTT) initiates an action in the transport stratum. This action consists of the establishment of a transport path from an OB Radio Module (commonly used by all

Railway Applications) to the Target FRMCS Transport Domain to carry the MC signalling of multiple OB MCX Clients. (I)

- 4.1.6.3.4. Due to this independency between NTT and ATP Session Start request, it might happen that the service availability in Target FRMCS Service Domain (the steps 3 in below procedure) is not achieved before the reception of the Session Start request from ATP (step 4). Several situations can occur among which one is considered below for proposing a non-nominal deviation of call flow. (I)
- 4.1.6.3.5. In the following, the “nominal call flow” implies that the “FSD available” state is reached before ATP Session Start request occurs and the “non-nominal” call flow implies that the “FSD available” state is after ATP Session Start request occurs. (I)
- 4.1.6.3.6. Both ATP-TS A and ATP-TS B which are involved in this procedure shall have dual FAs activation within FRMCS, one in the Serving FSD and one in the Target FSD. (M)

### **Prerequisites**

- 4.1.6.3.7. Here are the applicable prerequisites: (I)
- There is an ongoing H2H connection between ATP-OB and ATP-TS A, which is carried within FRMCS over an MCDATA IP Conn Session between OB\_MCDATAClient1 (in OB FRMCS) and TS\_MCDATAClient1 (in FRMCS Trackside Gateway 1). This is referred to as “ATP\_Connection1” in the following.
  - Both OB\_MCDATAClient1 and TS\_MCDATAClient1 are served in Serving FRMCS Domain.
  - Network Transition Trigger (NTT, see [FRMCS SRS] §10.1.2) is received at OB FRMCS.
  - A transport path (e.g., 5G PDU session) is established into the Target FRMCS Transport Domain which allows MC signaling with the MCDATA server at Target FRMCS Service domain.

### **Call flow**

- 4.1.6.3.8. The following steps are applicable (see Figure 18 and Figure 19):
- 1) OB FRMCS shall initiate a new MC ID, namely MC ID 2 @ Home FRMCS Service Domain. (M)
  - 2) The IdM client at OB FRMCS shall perform MC User Authentication and obtain a Token for migration to Target FSD according to [TS 33.180] Annex C.2. This Token includes MCDATA ID 2 @ Target FSD. (M)  
Note: IdM servers of both Home and Target FRMCS Domains are involved in this procedure).
  - 3) OB FRMCS shall initiate a new MCX Client, namely OB\_MCDATAClient2 and uses MCDATA ID 2 to initiate the Migration procedure according to [TS 23.280] §10.6.3.3.1. (M)



Note: At the completion of this procedure, OB FRMCS enters to the state of “FSD\_Available” in Target FRMCS Domain and can notify this state to ATP-OB.

- 4) At the reception of “connection order” for connecting to ATP-TS B, ATP-OB requests to open a Session on OB<sub>APP</sub>. (I)
- 5) At the reception of this open Session request on OB<sub>APP</sub>, OB FRMCS shall evaluate if the state “FSD\_Available” in Target FRMCS Service Domain is reached. (M)
- 6) If FSD\_Available in Target FSD is reached at step 5 (nominal situation, see Figure 18), OB FRMCS shall initiate “Session Start - H2H” procedure defined in section 2.1.3 leading to the establishment of an end-to-end connection between ATP-OB and ATP-TS B, which is carried within FRMCS over an MCDATA IP Conn Session between OB\_MCDATAClient2 (in OB FRMCS) and TS\_MCDATAClient2 (in FRMCS Trackside Gateway 2). (M)

*Note: the ATP-TS B is reachable through its FA in Target FSD which is activated on TS\_MCDATAClient2.*

- 7) If FSD\_Available in Target FSD is not reached at step 5 (one possible non-nominal call flow is shown in Figure 19): OB FRMCS, based on the progress of MC migration procedure, should support the following steps instead of waiting until FSD\_Available is reached: (O)
  - a. OB FRMCS performs “Session start - H2H” procedure defined in section 2.1.3. which establishes a second MCDATA IP Conn Session also through Serving FRMCS Service Domain between OB\_MCDATAClient1 (in OB FRMCS) and TS\_MCDATAClient1 (in FRMCS Trackside Gateway 1). Thanks to the FA activation of ATP-TS B on TS\_MCDATAClient1, the ATP-TS B is reachable by its FA in Serving FSD.
  - b. As soon as Target FSD is available this second connection between ATP-OB and ATP-TS B needs to be carried in Target FSD. For that, an MCDATA IP Conn Session needs to be established between OB\_MCDATAClient2 and TS\_MCDATAClient2. This time the ATP-TS B is reachable through its FA in Target FSD which is activated on TS\_MCDATAClient2.
  - c. The connection between ATP-OB and ATP-TS B will be moved over this Session in a transparent manner to the ATP application.

Note: This step could lead to a short interruption for which the impact will have to be evaluated.

- 8) At the reception of “termination order”, ATP\_OB requests to close the OBAPP Session corresponding to ATP-Connection 1. (I)
- 9) Upon reception of close Session request on OBAPP, OB FRMCS shall initiate “Session End – H2H” procedure in section 2.1.4. (M)

10) The closure of the corresponding Session over TSAPP can be done at ATP-TS A request independently. (I)

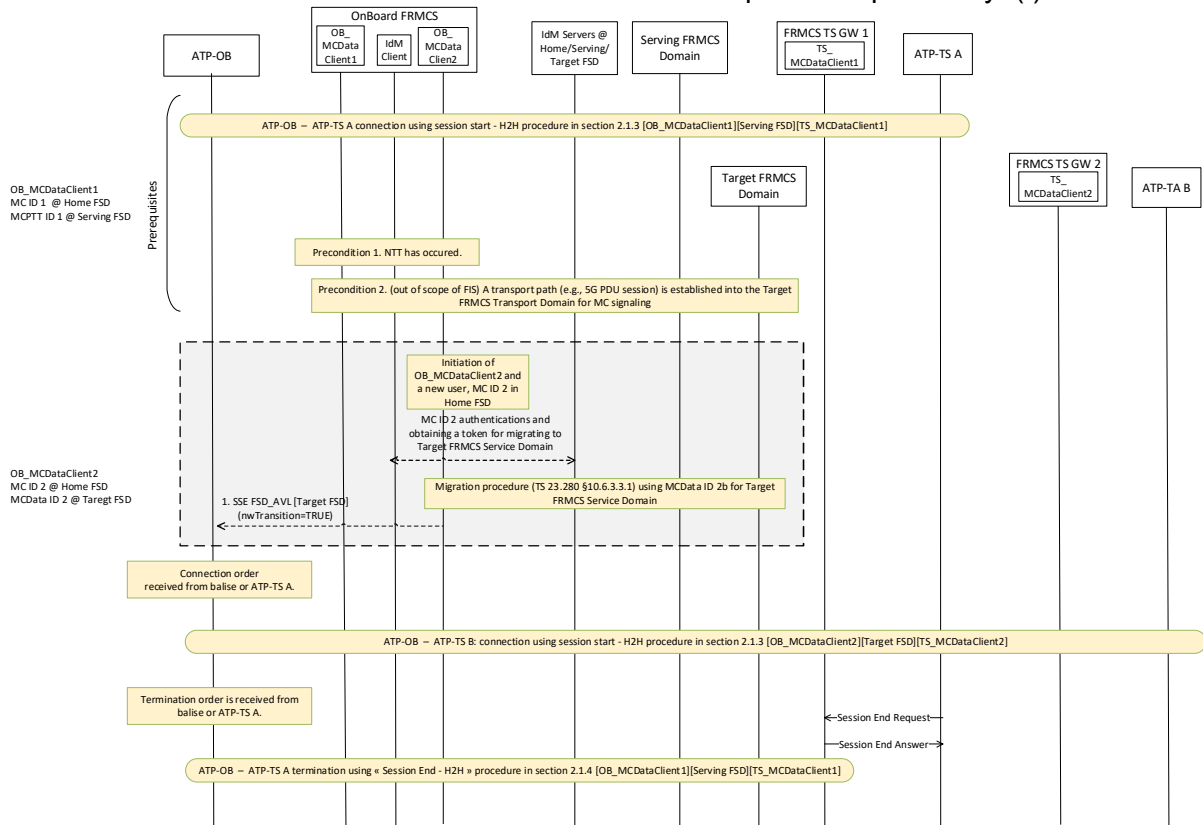

Figure 18. Nominal call flow for handover between ATP-TS Users in different service domain.

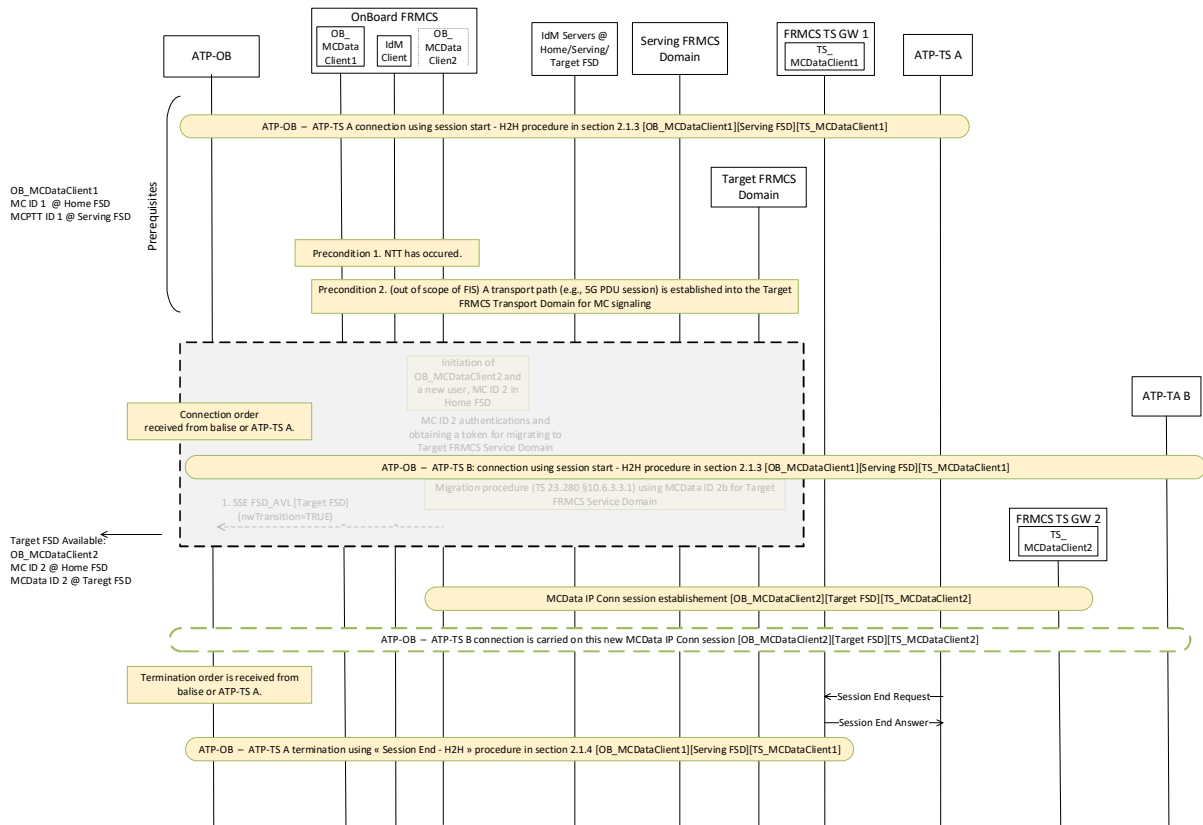

Figure 19. Non-nominal call flow for handover between ATP-TS Users in different service domain.

## 4.1.7. Handling of a PKI and KMS Sessions

### 4.1.7.1. General information

- 4.1.7.1.1. Intentionally deleted.
- 4.1.7.1.2. Intentionally deleted. (I)
- 4.1.7.1.3. Intentionally deleted. (I)
- 4.1.7.1.4. The H2N addressing mode is used at MCX level for communications related to PKI and KMS, see [FRMCS SRS]. (I)
- 4.1.7.1.4i It is assumed that the destination for the service setup is the home network. (I)
- 4.1.7.1.4ii The address of the home network is pre-configured in the Railway Application in SIP URI format. (I)
- 4.1.7.1.5. The PKI and KMS applications are using standard IP addressing over a MCDATA IPcon Service Session established between the onboard MCX Client and the FRMCS Trackside Gateway MCX Client that will relay the data stream towards the IP network where is located the partner application entities. (I)

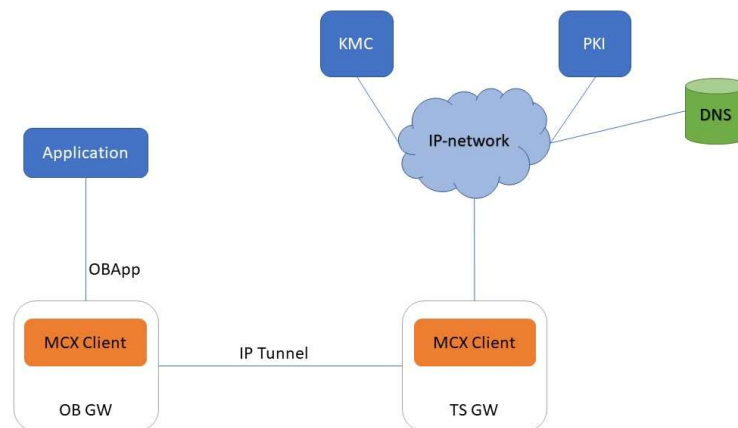

Figure 20: Addressing for PKI and KMS Session

### 4.1.7.2. Session Start

- 4.1.7.2.1. When required by the onboard Railway Application, a Session shall be initiated in accordance with the requirements specified in section 2.1.3. (M)

### 4.1.7.3. Session End

- 4.1.7.3.1. The Session shall be ended in accordance with the requirements specified in section 2.1.4. (M)

#### 4.1.7.4. Inter-FRMCS-Service-Domain Transition for PKI & KMS

- 4.1.7.4.1. The IFSDT procedure as described in section 3.4 shall be applied for H2N connection dedicated to PKI and/or KMS. (M-V3)

[Editor's Note7] <i>The way IFSDT will be performed for these KMS &amp; PKI applications has still to be clarified.</i>
---

## 4.2. Automatic train operation

### 4.2.1. Introduction

- 4.2.1.1.1. Intentionally deleted. (I)
- 4.2.1.1.2. There are several types of data communications related to the ATO application, (I)
  - a) between onboard entity and trackside entity, enabling the automatic train operation.
  - b) between trackside entities, enabling connection with other ATO trackside entities, TMS etc.
  - c) management and verification of security certificates for end-to-end communication (PKI).
- 4.2.1.1.3. Type a) is specified below using the loose-coupled interface mode. (I)
- 4.2.1.1.4. Type b) is a permanently connected links in the fixed PDN and out of scope of this specification. (I)
- 4.2.1.1.5. Type c) is specified by section 4.2.5 and is using the loose-coupled interface mode in H2N addressing mode. (I)

### 4.2.2. ATO User Registration

- 4.2.2.1.1. The MCX Client associated to ATO application (Onboard or Trackside) shall be registered to FRMCS System in accordance with the requirements specified by section 2.1.2 and section 3.1.2.2 of this document. (M).
- 4.2.2.1.2. An Functional Alias shall be activated for the ATO trackside User in the own FRMCS domain in accordance with the requirements specified by section 2.1.2 of this document. (M)
- 4.2.2.1.3. An Functional Alias should be activated for the ATO trackside User in any external FRMCS domain in accordance with the requirements specified by section 2.1.2 of this document. (O)
- 4.2.2.1.4. Activation of an Functional alias in an external FRMCS domain enable setting up a Session in which the Onboard ATO User is located outside the domain of the Trackside ATO User. (I)
- 4.2.2.1.5. The format of the Functional alias shall be a SIP URI using the FQDN according to [SUBSET-037-3] as user part. (M)

### 4.2.3. Use of FRMCS location services

- 4.2.3.1.1. The location information available from FRMCS is used neither for ATP application internal purpose nor for routing of the ATP communication. (I)

### 4.2.4. QoS and priority

- 4.2.4.1.1. Intentionally deleted. (I)

- 4.2.4.1.2. The QoS and priority shall be managed according to requirements specified within section 2.1.3 and to requirements specified in [FRMCS SRS] regarding the QoS level to use. (M)

#### 4.2.5. Handling of an ATO Session

- 4.2.5.1.1. An ATO Session shall be handled in the same way as the one specified in section 4.1.5 for an ATP Session. (M)
- 4.2.5.1.2. The remote identifier (identity of the recipient) shall comply to the FQDN format specified in [SUBSET-037-3]. (M)

#### 4.2.6. Handling of ATO-TS responsibility handover

- 4.2.6.1.1. The responsibility handover for an ATO Session shall be handled in the same way as the one specified in section 4.1.6 for an ATP Session. (M)

#### 4.2.7. Handling of a PKI (Security Certificate management) Session

- 4.2.7.1.1. A PKI session for the ATO application shall be handled as specified in section 4.1.7 for a PKI Session related to the ATP application. (M)

## 4.3. Railway emergency communication

### 4.3.1. Introduction

- 4.3.1.1.1. Railway Emergency Communication (REC) is specified according to the requirements of the section 10.11 in [FRMCS FRS]. (I)
- 4.3.1.1.2. The REC in gateway access mode shall use the TC mode as described in section 1.3 of this document. (M)

### 4.3.2. REC User Registration and Role Management

- 4.3.2.1.1. The MCX Client used to connect a User to a REC shall register to FRMCS System in accordance with the requirements specified by section 3.1.2.3 of this document in order to perform REC. (M)
- 4.3.2.1.2. The MCX Client associated to a REC User using the gateway access mode shall in addition comply to the requirements specified by section 2.2.2 of this document. (M)
- 4.3.2.1.2i The MCX Client associated to a REC User shall have registered to a Functional Identity in accordance with the requirements specified by section 3.1.3 of this document in order to perform REC. (M)

### 4.3.3. REC Types

- 4.3.3.1.1. In order to cover the different variants of REC specified within [FRMCS FRS], the following types of REC have to be defined in this document due to the fact they could correspond to different message flows: (I)
  - a) Standalone REC alert
  - b) Combined REC alert & REC voice: REC alert with an additional REC voice
  - c) Combined REC alert & REC data: REC alert with an additional REC data
- 4.3.3.1.2. The Standalone REC alert shall use the Alert flow defined in Sections 4.3.6.5, 4.3.6.6 and 4.3.6.7. (M-Vx)
- 4.3.3.1.3. The Combined REC alert and REC voice shall use the Alert flow defined in Sections 4.3.6.5, 4.3.6.6 and 4.3.6.7 and subsequently (or simultaneously) use the REC voice flow defined in Sections 4.3.6.2, 4.3.6.3, 4.3.6.4 and 4.3.6.8. (M)
- 4.3.3.1.4. The combined REC alert and REC voice shall use the same MC Service Group ID in the system. (M)
- 4.3.3.1.5. The Combined REC alert and REC data shall use the Alert flow defined Sections 4.3.6.5, 4.3.6.6 and 4.3.6.7 and subsequently (or simultaneously) use the REC data flow defined in Sections 4.3.6.2, 4.3.6.3, 4.3.6.4 and 4.3.6.8. (M-Vx)

- 4.3.3.1.6. The combined REC alert and REC data shall use the same group ID in the system. (M-Vx)

[Editor's Note8] *Combined REC alert & REC data (Type c) is currently not fully specified in this version of the document.*

[Editor's Note9] *Only the immediate automatic setup of a REC voice or REC data after a REC alert is currently defined.*

#### 4.3.4. REC principles

- 4.3.4.1.1. This section defines the generic requirements for REC which are denoted as REC principles. (I)
- 4.3.4.1.2. The REC principles specified in this section shall apply whatever is the REC Type. (M)
- 4.3.4.1.3. The process for determination of the REC participants shall take the following information into account: (M)
- a) Current Location of mobile Users
  - b) Current Role (Functional Alias) of Users
- 4.3.4.1.3i The process for determination of the REC participants should take the following information into account: (O-Vx)
- a) Current speed of mobile Users
  - b) Current heading of mobile Users
- 4.3.4.1.4. The determination of the location of mobile Users shall be based on the generic Location services and Location reporting described in section 3.2. (M)
- 4.3.4.1.5. In this document, the concept of “predefined Initiating Area” and “predefined addressed area” defined in [FRMCS FRS] is further specified in order to achieve the technical implementation of the functional requirements as illustrated in the figure below. (I)



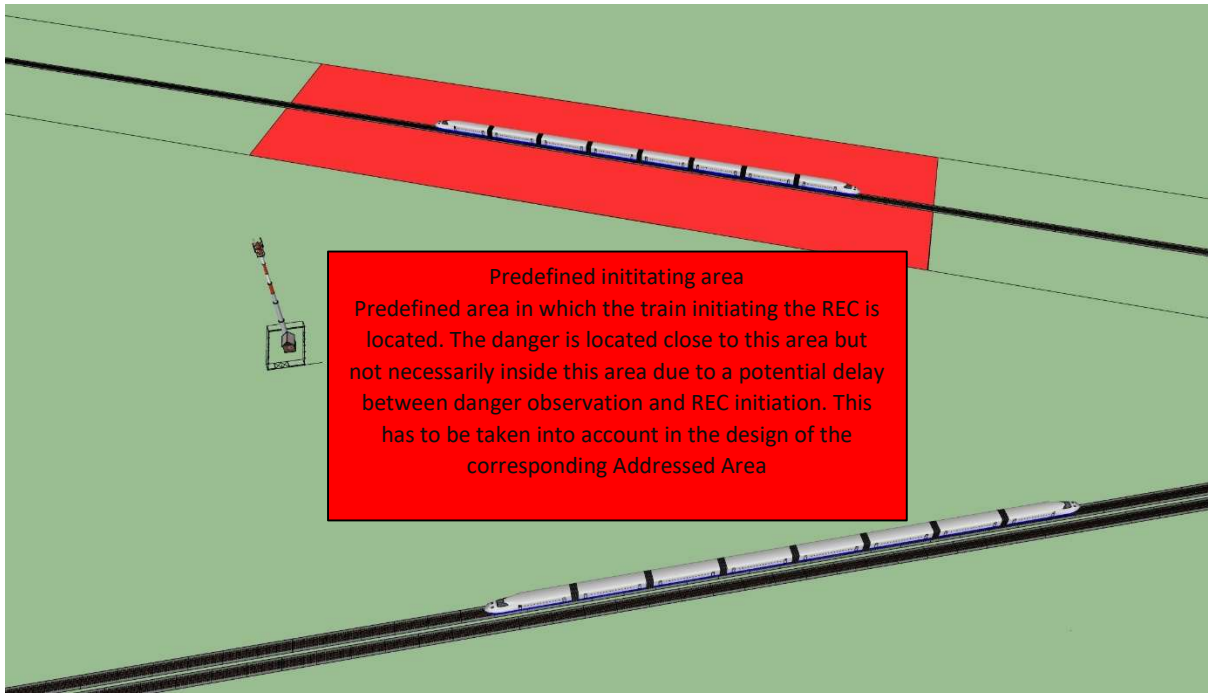

Figure 21: Selected Initiating Area upon REC initiation

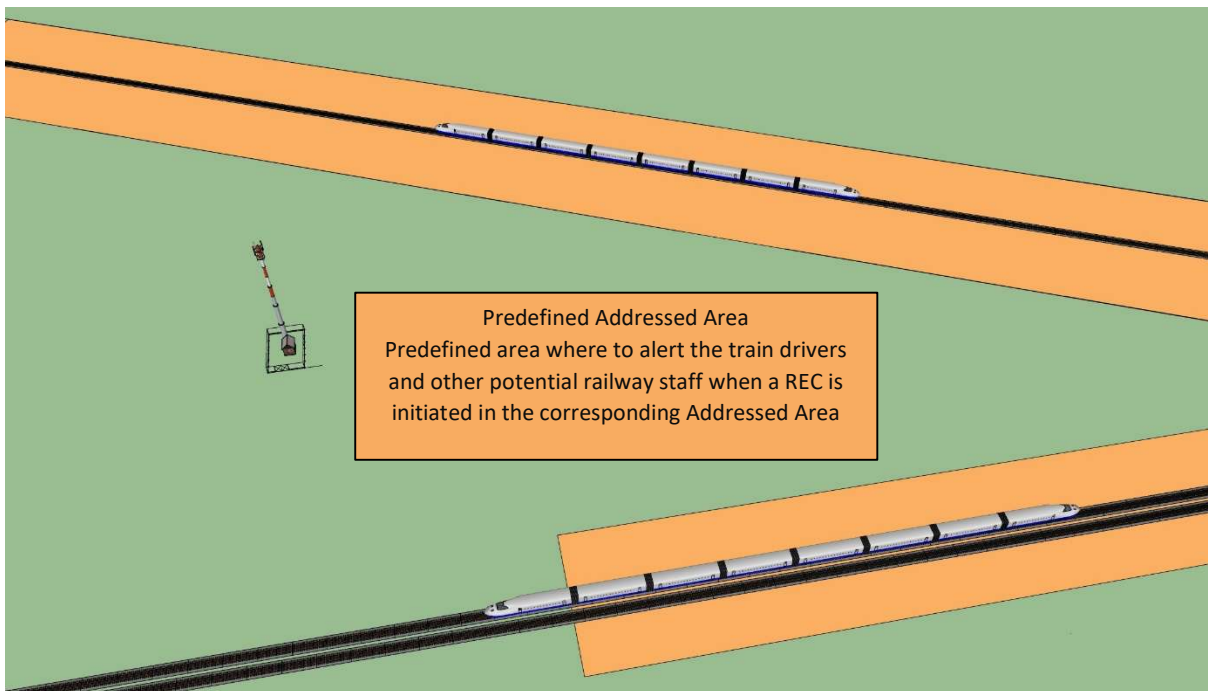

Figure 22: Addressed area corresponding to selected Initiating Area

- 4.3.4.1.6. Intentionally deleted.
- 4.3.4.1.7. Intentionally deleted.
- 4.3.4.1.7i Consideration of route setting in the REC participants determination process is considered out of FIS scope. (I)
- 4.3.4.1.8. The Location Area definition in current version of FIS shall be based on polygon area definition as per [TS 24.484]. (M)

- 4.3.4.1.9. The current location of a mobile initiator (calling party) shall be provided during the call setup request message as specified in sections 4.3.6.2 and 4.3.6.5. (M)

#### 4.3.5. QoS and priority

- 4.3.5.1.1. The QoS and priority to use for REC-alert is defined in [FRMCS SRS]. (I)
- 4.3.5.1.1i The QoS and priority to use for REC-voice is defined in [FRMCS SRS]. (I)
- 4.3.5.1.1ii The MCX Client associated with the voice communication application shall request the QoS and priority level as specified within [TS 103 765-1]. (M)
- 4.3.5.1.2. The MCX Client associated with the voice communication application shall be able to provide the requested application priority as specified within section 3.3. (M-V3)
- 4.3.5.1.3. The MCX Server is responsible for the determination of the appropriate QoS and for the propagation to the transport layer (see [FRMCS SRS] for details about QoS and priority). (I)

#### 4.3.6. REC flows

##### 4.3.6.1. General

- 4.3.6.1.1. The REC flows described below are based on the principles defined in section 4.3.4. (I)
- 4.3.6.1.2. The REC flows are valid for REC voice and REC data services (I)
- 4.3.6.1.3. The call related operations as defined in the subsequent chapters shall be achieved if, as prerequisite, the following conditions are fulfilled: (M)
  - a) Initiating and addressed area are configured.
  - b) Controllers identities associated to addressed area are configured.
  - c) Authorization for controllers to initiate and/or receive and/or terminate a REC are configured.
  - d) Authorization for mobile Users to receive and/or initiate and/or terminate a REC are configured for each function label (role).
  - e) Controllers functional identities have been activated for participating controllers.
  - f) Mobile Users functional aliases have been activated for participating mobile Users.
  - g) Location information related to the MCX Clients of the mobile Users received through location reports as defined in section 3.2.2. is available.
- 4.3.6.1.4. The following Figure 23 illustrates the pre-requisites. (I)

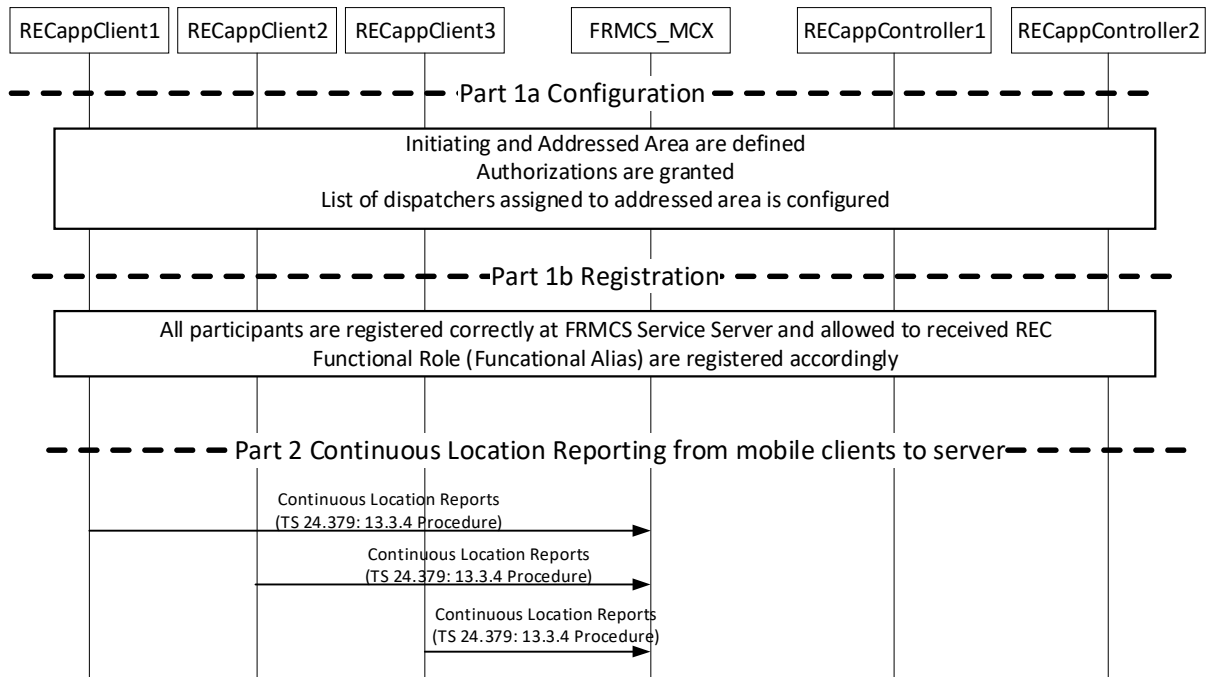

Figure 23: Pre-requisites for REC call related operations

4.3.6.1.5. Initiation of all REC call types shall not set the 3GPP MCX "Emergency Indicator" in all relevant information elements of MCX ad hoc group calls and MCX ad hoc group emergency alert. (M)

#### 4.3.6.2. REC flow for setup

4.3.6.2.1. The REC flow for setup of a mobile User-initiated REC shall conform to the flows depicted in Figure 24. (M)

4.3.6.2.1i The REC call flow for setup of a mobile User-initiated REC shall be aligned with the ad hoc group call specification in [TS 23.379] for the case "Ad hoc group call setup with MCPTT server determining the participants lists" and shall use related Stage-3 procedures using "on-demand" Session in [TS 24.379]. (M)

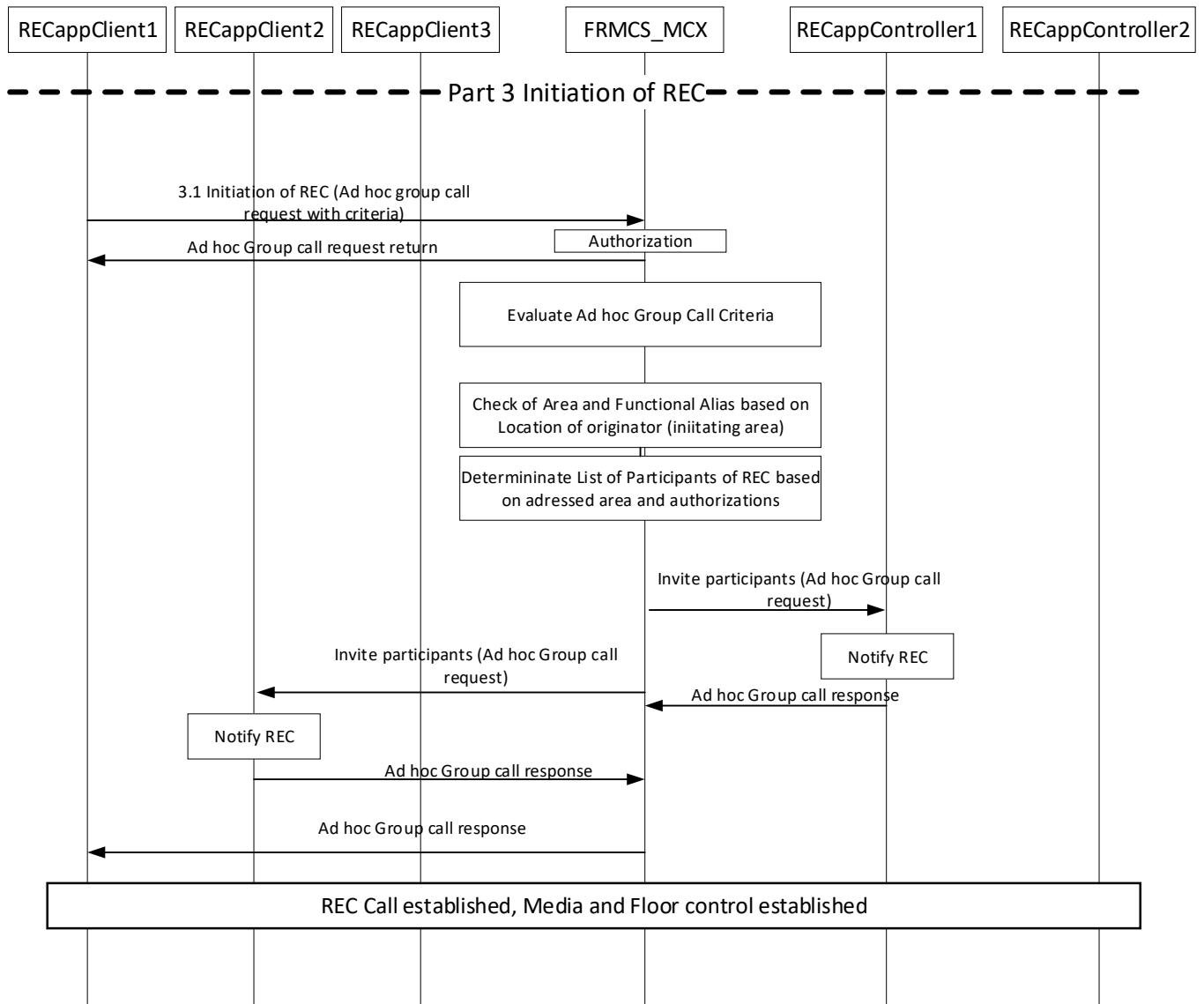

Figure 24: REC flow for mobile originating REC

Flow Description:

- 4.3.6.2.1ii As depicted in Figure 24, a RECCappClient shall initiate the REC as an Ad hoc group call with criteria parameter FRMCS\_CallType set to FRMCS\_CT\_REC. (M)
- 4.3.6.2.1iii To achieve the call related operation depicted in Figure 24, the FRMCS\_MCX Server shall: (M)
  - a) evaluate the Ad hoc Group Call criteria.
  - b) determine the Initiating Area and functional alias based on the location of the originator.
  - c) determine the addressed area.
  - d) determines the list of participants or the REC based on addressed area and respective authorizations and available predefined definitions for the addressed area (e.g. responsible controllers).

- e) invites the determined participants to the Ad hoc Group call and establishes the respective media and floor control.
- 4.3.6.2.1iv As the outcome of the call related operations depicted in Figure 24, the REC shall be established and kept ongoing between all determined participants. (M)
- 4.3.6.2.1v The functional alias of the initiator of the REC shall be provided as "functional alias of the calling party" as per information element "functional alias" in Ad hoc group call request in [TS 23.379] Table 10.19.2.1-1. (M)
- 4.3.6.2.2. The setup of a dispatcher initiated REC shall conform to the REC flow as depicted in Figure 25 for which the addressed area shall be directly provided through the criteria:
- a) FRMCS\_Use AdressedArea and FRMCS\_ListOfAdressedArea. (M) or
  - b) FRMCS\_Use InitiatingArea and FRMCS\_ListOfInitiatingArea. (M-Vx)

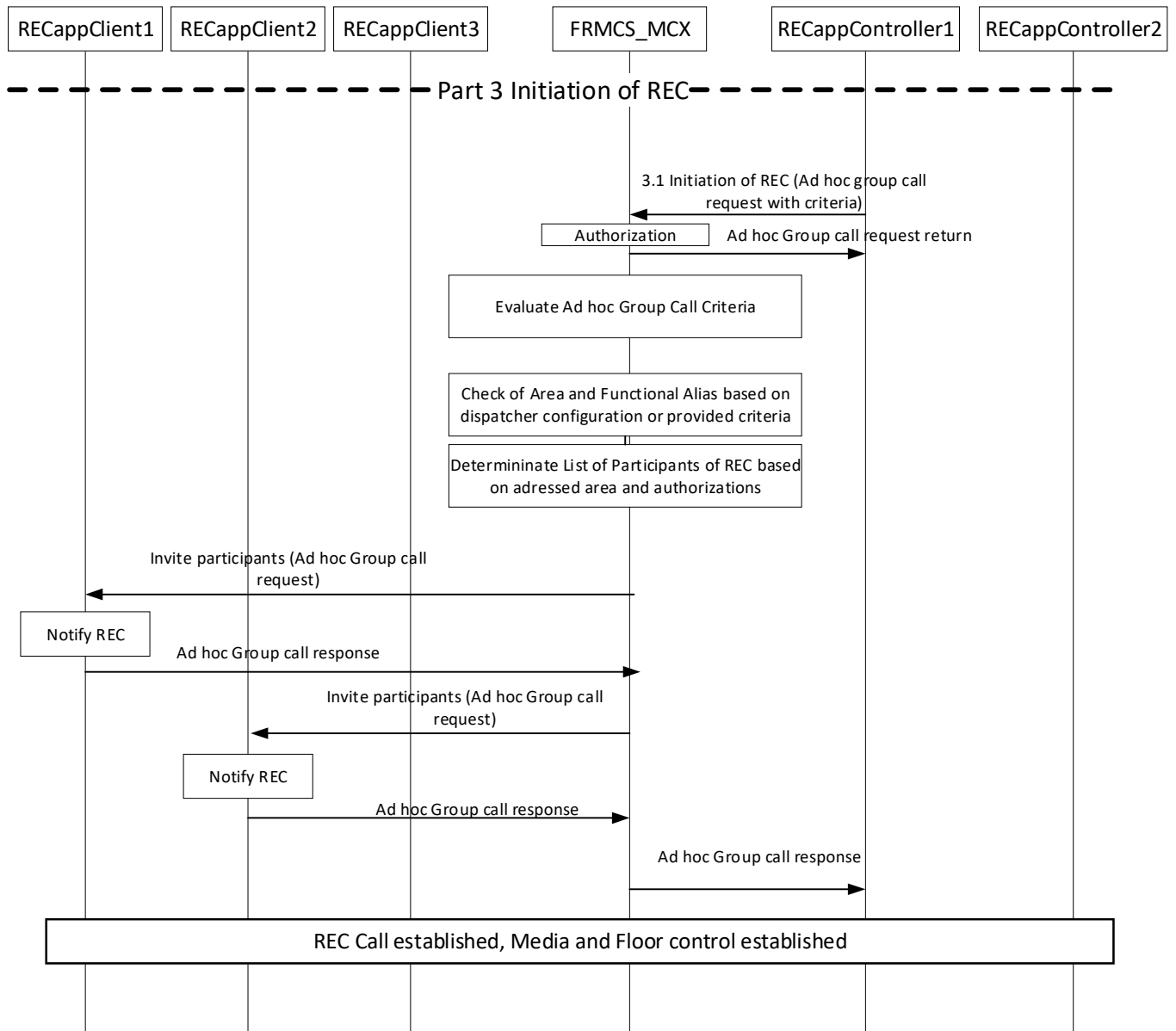

Figure 25: REC flow for dispatcher originating REC.

4.3.6.2.3. The REC flow for setup of a dispatcher initiated REC shall use the appropriate Location Area criteria (Addressed or Initiating Area) specified in 4.3.6.10 during Ad hoc group call request from the dispatcher. (M)

#### 4.3.6.3. REC flow for entry and leaving addressed area

4.3.6.3.1. The REC flow to add and remove a mobile User to/from the REC communication due to change of User's location shall be based on the Procedure "Modification of ad hoc group call participants by the MCPTT server" in [TS 23.379] and shall use related Stage-3 procedures using "on-demand" Session in [TS 24.379], following principles shown in Figure 26 and Figure 27. (M)

4.3.6.3.1i The REC flow to add and remove a mobile User to/from the REC communication due to change of User's location shall conform to the flows depicted in Figure 26. (M)

4.3.6.3.2. This flow covers use cases for "Late Entry" in the sense of moving into the area but also when Mobiles are turned on or off inside the addressed area. (I)

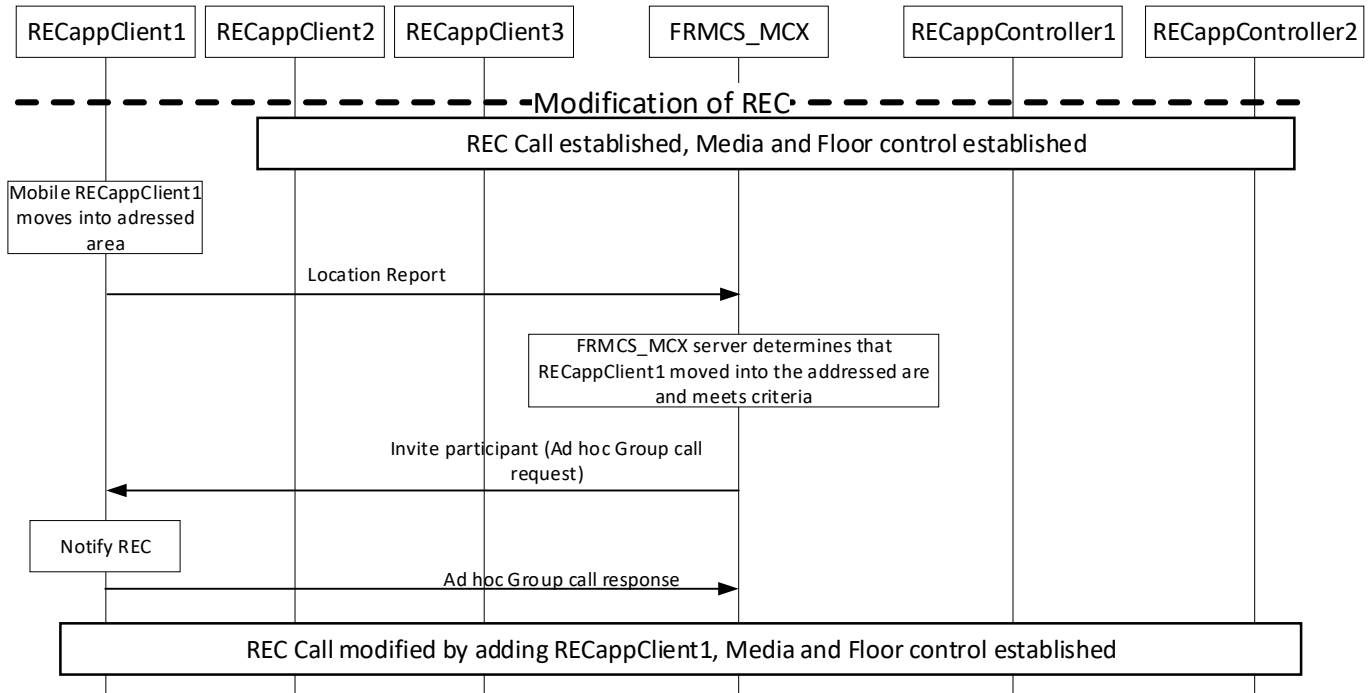

Figure 26: REC flow for adding User based on client movement.

Flow Description:

Part 1: Established REC

4.3.6.3.3. The call related operations depicted in Figure 26 to add a User to REC due to change of User's location shall be achieved if, as prerequisite, a REC is established and ongoing in addressed area between participants (except REAppClient1). (M)

Part 2: Entry of REAppClient3

4.3.6.3.4. To achieve the call related operations depicted in Figure 26, the FRMCS\_MCX Server shall: (M)

- c) detect that Mobile REAppClient1 moves into addressed area based on the updated location reported by the Mobile REAppClient1 to the FRMCS\_MCX Server
- d) check the Functional Alias and associated permissions of the moving client
- e) re-determine the members of the REC (based on the above evaluations and the addressed area and Ad hoc group criteria)

Part 3: Update of REC

4.3.6.3.5. As the outcome of the call related operations depicted in Figure 26, the REC shall be updated and kept ongoing between all determined participants including REAppClient1. (M)

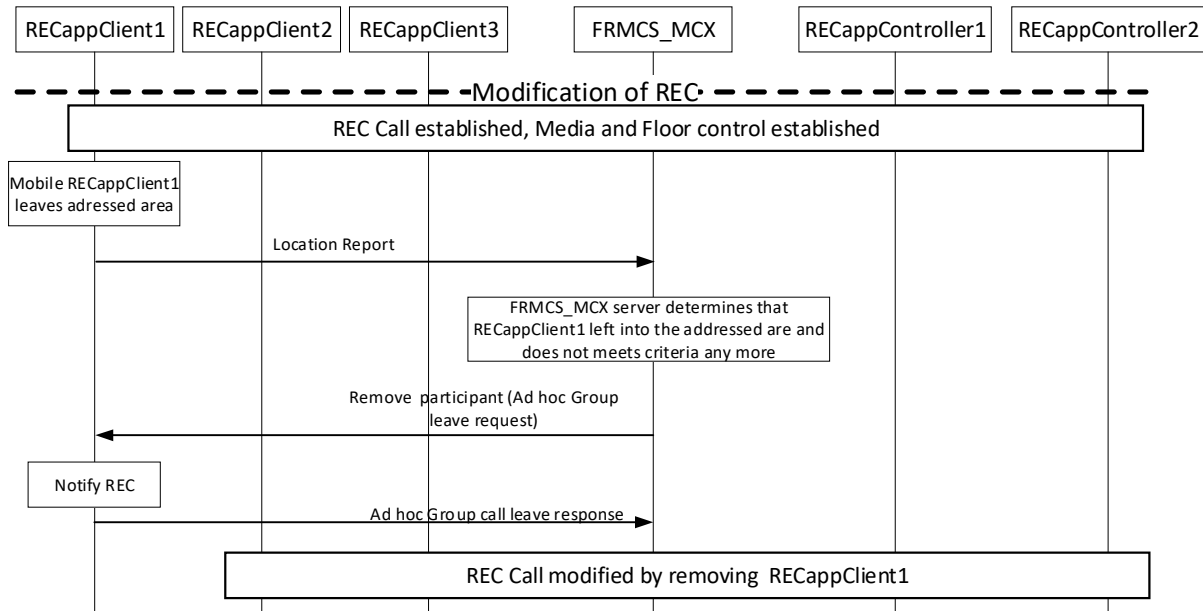

Figure 27: REC flow for removing User based on client movement

Flow Description:

Part 1: Established REC

4.3.6.3.6. The call related operations depicted in Figure 27 to remove a User from REC due to change of User's location shall be achieved if, as prerequisite, a REC is established and ongoing in addressed area between participants (including REAppClient1). (M)

Part 2: Removal of REAppClient1

4.3.6.3.7. To achieve the call related operations depicted in Figure 27, the FRMCS\_MCX Server shall: (M)

- a) detect that Mobile REAppClient1 leaves the addressed area based on the updated location reported by the Mobile REAppClient1 to the FRMCS\_MCX Server
- b) check the Functional Alias and associated permissions of the moving client
- c) re-determine the members of the REC (based on the above evaluations and the addressed area and Ad hoc group criteria)

Part 3: Update of REC - Depending on REC method



4.3.6.3.8. As the outcome of the call related operations depicted in Figure 27, the REC shall be updated and kept ongoing between all determined participants excluding RECCappClient1. (M)

#### 4.3.6.4. REC flow for change of User's eligibility criteria

4.3.6.4.1. The REC flow to add and remove a User to/from the REC communication due to change of eligibility criteria shall be based on the Procedure "Modification of ad hoc group call participants by the MCPTT server" in [TS 23.379] and shall use related Stage-3 procedures using "on-demand" Session in [TS 24.379]. (M)

4.3.6.4.1i The REC flow to add and remove a User to/from the REC communication due to change of eligibility criteria shall conform to the flows depicted in Figure 28 and Figure 29. (M)

4.3.6.4.2. This flow is e.g. applicable if User was already located in the addressed area but not registered in a role matching the criteria. As soon as he registers a functional identity matching the criteria, he joins the REC. (I)

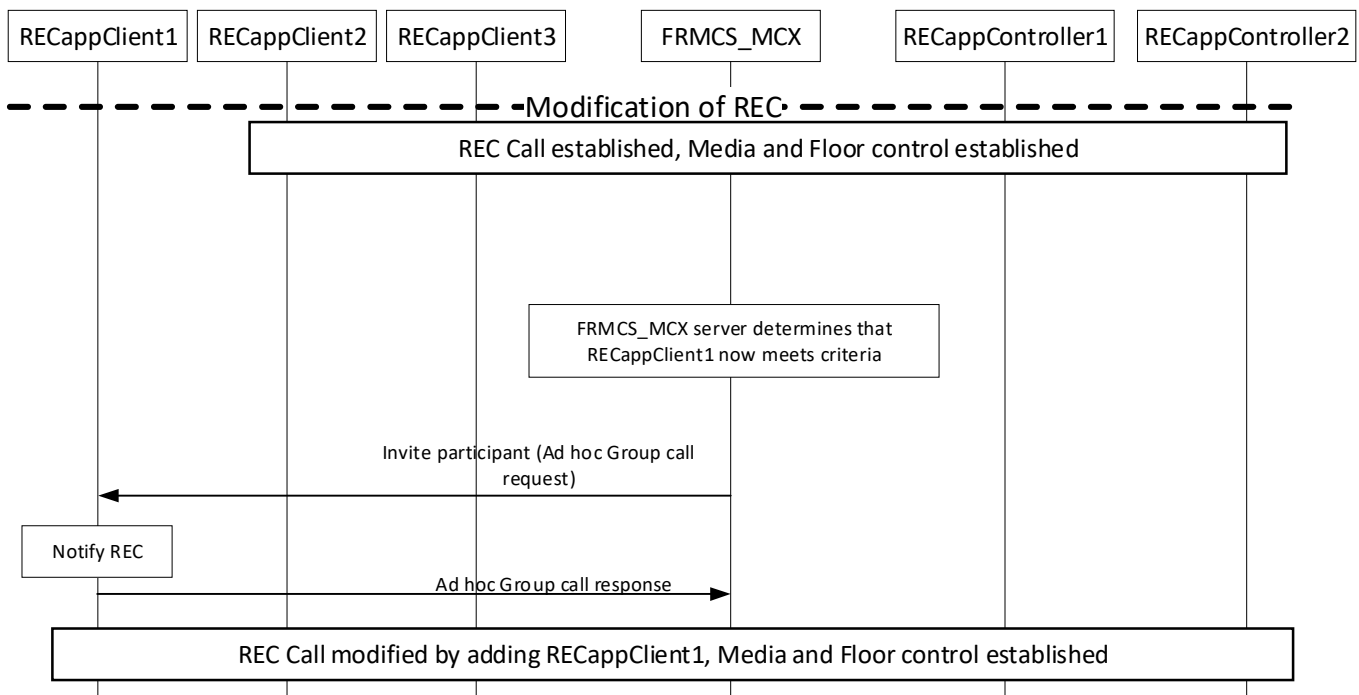

Figure 28: REC flow for adding a User based on evaluation of criteria

Flow Description:

Part 1: Established REC

4.3.6.4.3. The call related operations depicted in Figure 28 to add a User to the REC due to change of eligibility criteria shall be achieved if, as prerequisite, a REC is established and ongoing in

addressed area between participants except REAppClient1.  
(M)

Part 2: Entry of REAppClient1

4.3.6.4.4. To achieve the call related operations depicted in Figure 28, the FRMCS\_MCX Server shall : (M)

- a) Detect that the REAppClient1 is eligible to enter the call (by meeting the criteria)
- b) check the Functional Alias and associated permissions of the client
- c) re-determine the members of the REC (based on the above evaluations and the addressed area and Ad hoc group criteria)

Part 3: Update of REC

4.3.6.4.5. As the outcome of the call related operations depicted in Figure 28, the REC shall be updated and kept ongoing between all determined participants including REAppClient1. (M)

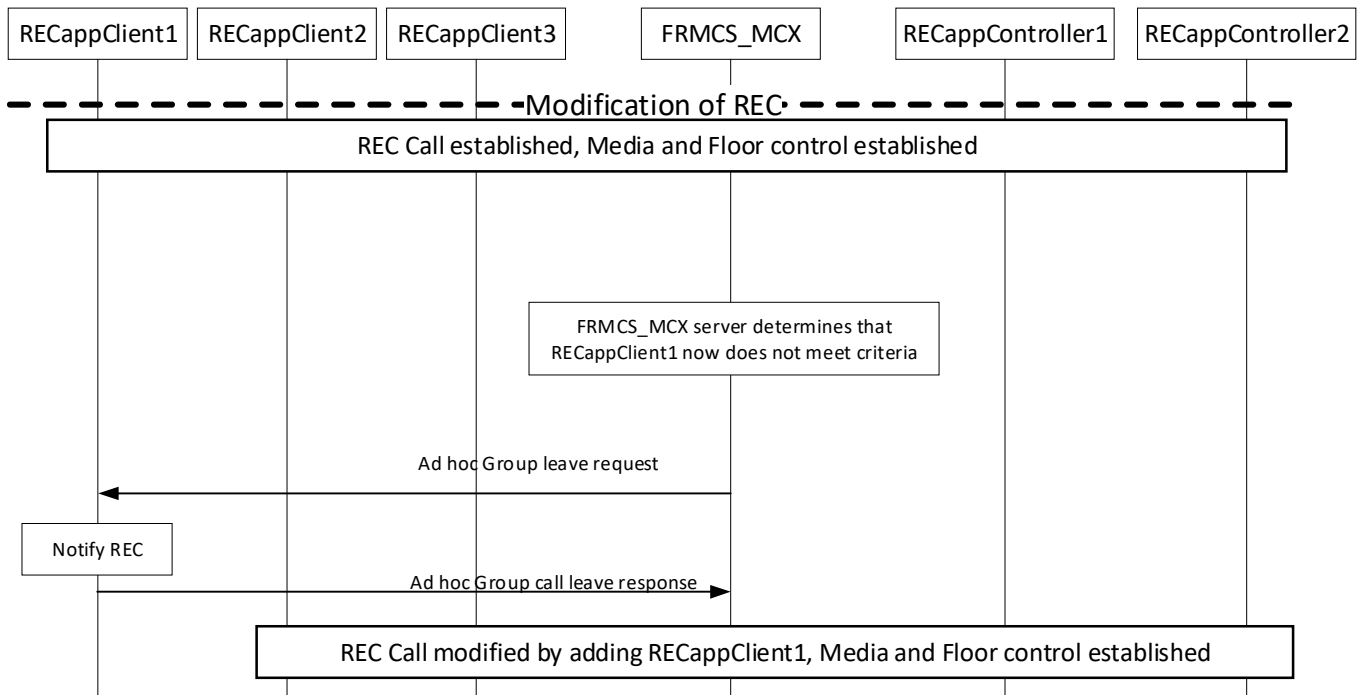

Figure 29: REC flow for removing a User based on evaluation of criteria

Flow Description:

Part 1: Established REC

4.3.6.4.6. The call related operations depicted in Figure 29 to remove a User from the REC due to change of eligibility criteria shall be achieved if, as prerequisite, a REC is established and ongoing in addressed area between participants including REAppClient1. (M)

## Part 2: Leaving of REAppClient1

- 4.3.6.4.7. To achieve the call related operations depicted in Figure 29, the FRMCS\_MCX Server shall : (M)
- a) detect that the REAppClient1 is not any more eligible to be part of the call (by not meeting the criteria any more)
  - b) check the Functional Alias and associated permissions of the client
  - c) re-determine the members of the REC (based on the above evaluations and the addressed area and Ad hoc group criteria)

## Part 3: Update of REC

- 4.3.6.4.8. As the outcome of the call related operations depicted in Figure 29, the REC shall be updated and kept ongoing between all determined participants excluding REAppClient1. (M)

### 4.3.6.5. REC Alert flow for setup

- 4.3.6.5.1. The REC alert flow for setup of a mobile User-initiated REC alert shall conform to the flows depicted in Figure 30. (M)

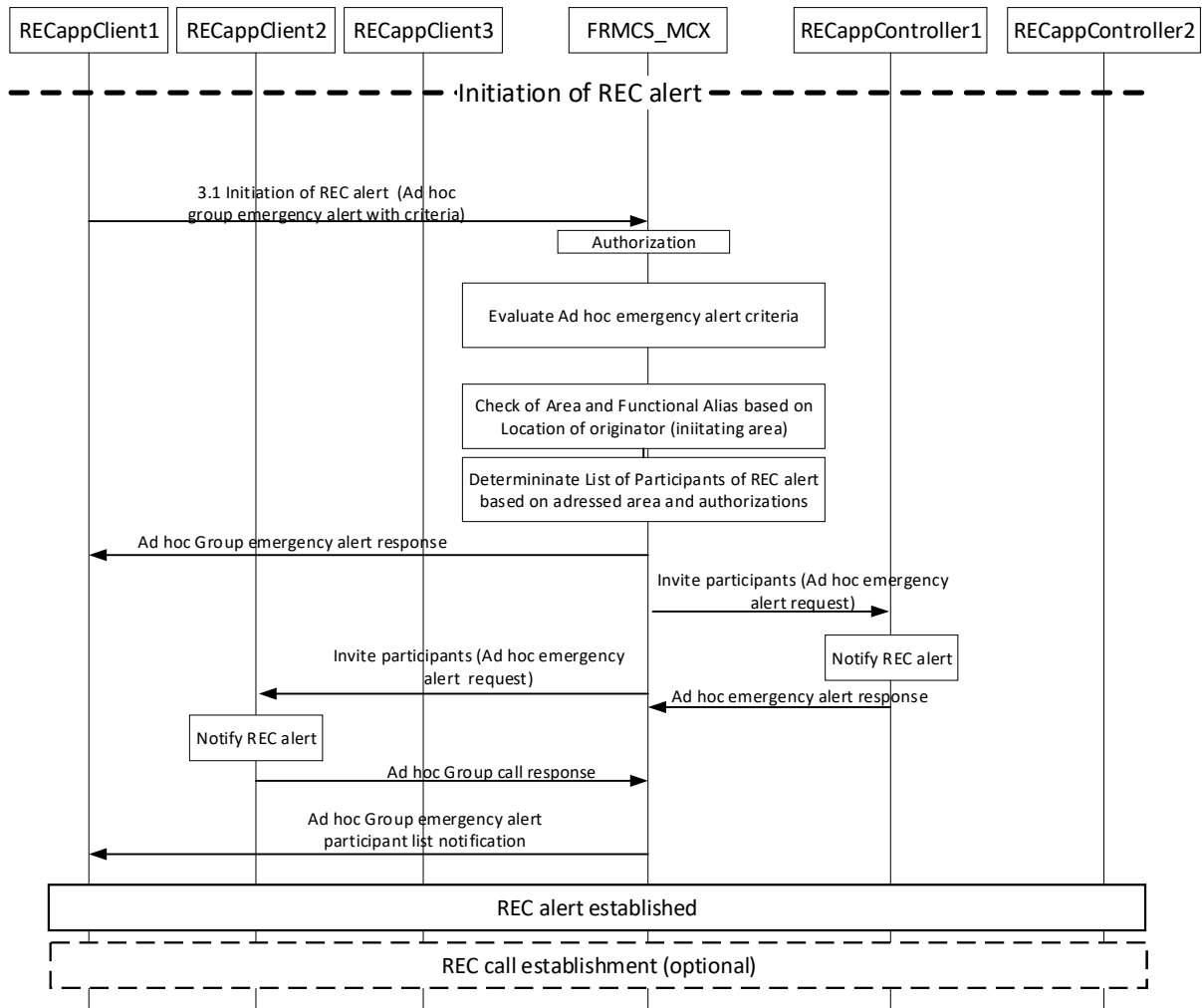

Figure 30: Flow for setup of REC alert

4.3.6.5.2. The REC alert flow for setup of a mobile User-initiated REC alert shall be aligned with the ad hoc group emergency alert specification in [TS 23.379] for the case “Ad hoc group emergency alert initiation”. (M)

[Editor's Note10] *In this version of the document only the MCPTT part of the “Ad hoc group emergency alert” as specified in [TS 23.379] is considered*

Flow Description:

- 4.3.6.5.2i As depicted in Figure 30, a RECCappClient shall initiate the REC alert as an Ad hoc group emergency alert with criteria parameter FRMCS\_CallType set to FRMCS\_CT\_REC. (M)
- 4.3.6.5.2ii To achieve the call related operation depicted in Figure 30, the FRMCS\_MCX Server shall: (M)
  - a) evaluate the Ad hoc Group emergency alert criteria

- b) check the area and functional alias based on the location of the originator
- c) determine the addressed area
- d) determine the list of participants or the REC based on addressed area and respective authorizations and available predefined definitions for the addressed area (e.g. responsible controllers).
- e) invite the determined participants to the Ad hoc Group emergency alert and establishes the respective emergency alert with all determined participants.

- 4.3.6.5.2iii As the outcome of the call related operations depicted in Figure 30, the REC alert shall be established and kept ongoing between all determined participants. (M)
- 4.3.6.5.2iv The functional alias of the initiator of the REC alert shall be provided as "functional alias of the calling party" as per information element "functional alias" in Ad hoc group call request in [TS 23.379] Table 10.19.2.1-1. (M)
- 4.3.6.5.3. The MCX Client associated to the REC User having initiated the REC alert shall set up a REC voice, based on the same participants as for the REC alert, immediately after the completion of the REC alert setup. (M)

[Editor's Note11] *The previous requirement could be relaxed in a future version of this specification in case standalone REC alert will be supported. This is the minimum to cope with GSM-R coexistence phase.*

- 4.3.6.5.4. The setup of a dispatcher initiated REC shall conform to the Flow described in 4.3.6.5.1, 4.3.6.5.2 and 4.3.6.5.3 for which the Location Area – as specified in 4.3.6.10 during Ad hoc group emergency alert from the dispatcher at the initiation of REC – shall be directly provided through the following criteria:
  - a) FRMCS\_Use\_AddressedArea and FRMCS\_ListOfAddressedArea (M) or
  - b) FRMCS\_Use\_InitiatingArea and FRMCS\_ListOfInitaitingArea (M-Vx)

#### 4.3.6.6. REC Alert flow for entry and leaving addressed area

- 4.3.6.6.1. The REC alert flow to add and remove a mobile User to/from the REC Alert due to change of User's location shall be based on the Procedure "Entering an ongoing ad hoc group emergency alert" in [TS 23.379] and shall conform to the flows depicted in Figure 31 and Figure 32. (M)
- 4.3.6.6.2. This flow covers use cases for "Late Entry" in the sense of moving into the area but also when Mobiles are turned on or off inside the addressed area. (I)

[Editor's Note12] In this version of the document only the MCPTT part of the “Ad hoc group emergency alert” as specified in [TS 23.379] is considered.

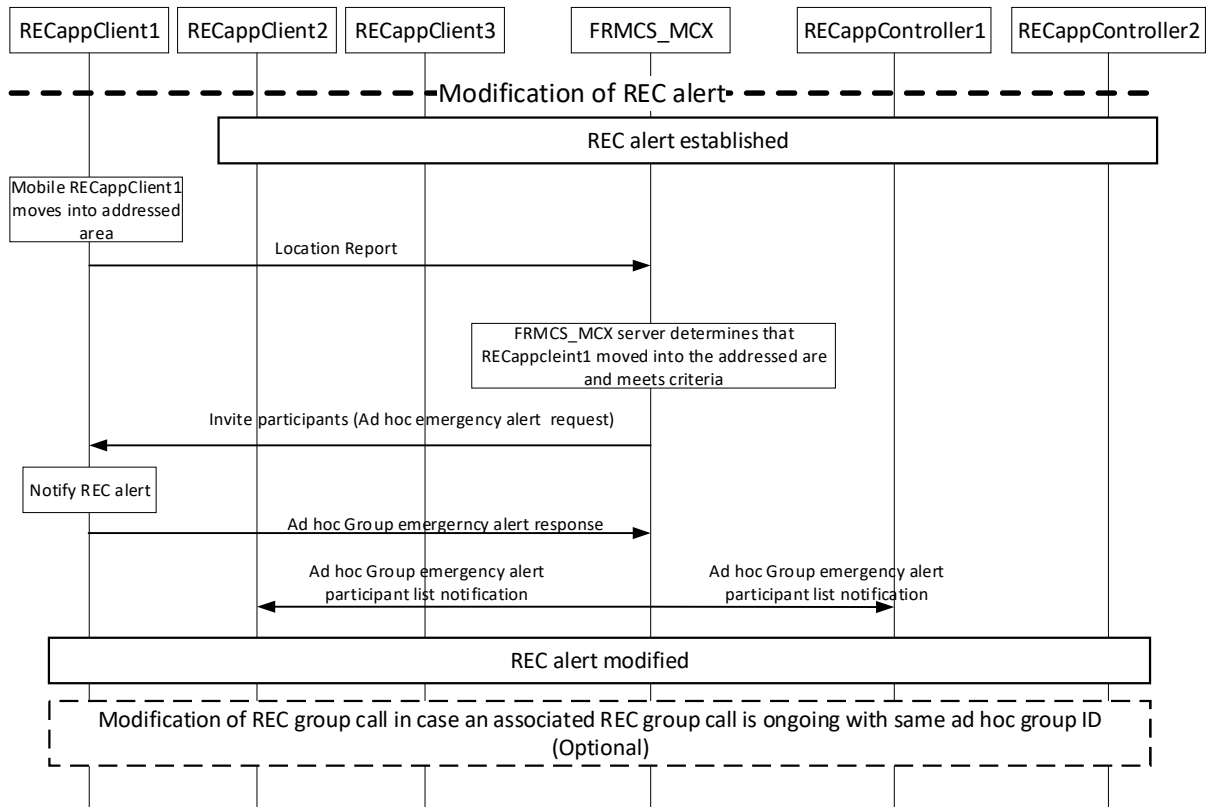

Figure 31: REC alert flow for adding a User based on client movement

Flow Description:

Part 1: Established REC alert

4.3.6.6.3. The call related operations depicted in Figure 31 to add a User to the REC Alert due to change of User’s location shall be achieved if, as prerequisite, a REC Alert is established and ongoing area between all participants except REAppClient1. (M)

Part 2: Entry of REAppClient1

4.3.6.6.4. To achieve the call related operations depicted in Figure 31, the FRMCS\_MCX Server shall: (M)

- a) detect that Mobile REAppClient1 moves into addressed area based on the updated location reported by the Mobile REAppClient1 to the FRMCS\_MCX Server
- b) check the Functional Alias and associated permissions of the moving client
- c) re-determine the members of the REC alert (based on the above evaluations and the addressed area and Ad hoc group criteria)

Part 3: Update of REC alert

4.3.6.6.5. As the outcome of the call related operations depicted in Figure 31, the REC alert shall be updated and kept ongoing between all determined participants including RECCappClient1. (M)

4.3.6.6.6. If there is an associated REC group call ongoing with the same ad hoc group ID as the one used for REC Alert depicted in Figure 31, this REC group call shall be modified accordingly with the same updated participant list. (M)

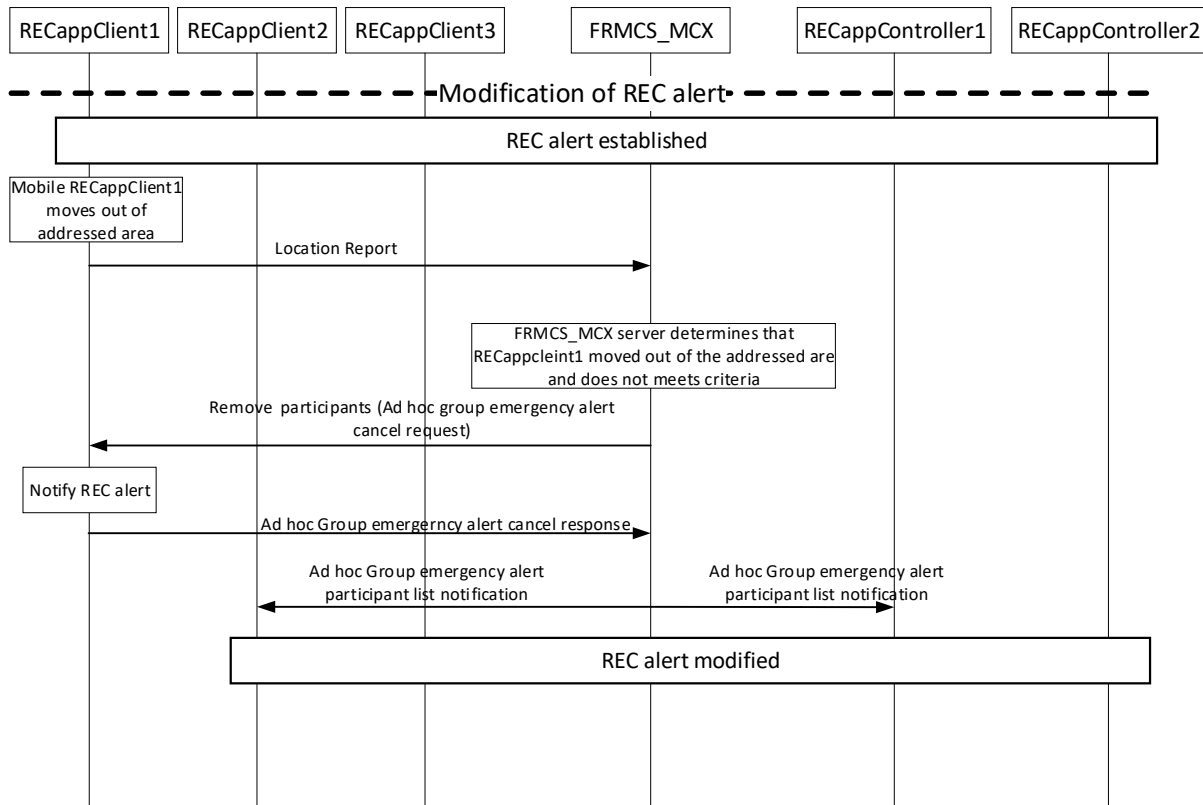

Figure 32: REC alert flow for removing a User based on client movement

Flow Description:

Part 1: Established REC alert

4.3.6.6.7. The call related operations depicted in Figure 32 to remove a User from the REC Alert due to change of User's location shall be achieved if, as prerequisite, a REC Alert is established and ongoing area between all participants including RECCappClient1. (M)

Part 2: Removal of RECCappClient1

4.3.6.6.8. To achieve the call related operations depicted in Figure 32, the FRMCS\_MCX Server shall : (M)

- a) detect that Mobile REAppClient1 leaves the addressed area based on the updated location reported by the Mobile REAppClient1 to the FRMCS\_MCX Server
- b) check the Functional Alias and associated permissions of the moving client
- c) re-determine the members of the REC (based on the above evaluations and the addressed area and Ad hoc group criteria)

Part 3: Update of REC alert

4.3.6.6.9. As the outcome of the call related operations depicted in Figure 32, the REC alert shall be updated and kept ongoing between all determined participants excluding REAppClient1. (M)

4.3.6.7. REC Alert flow for change of eligibility criteria

4.3.6.7.1. The REC alert flow to add and remove a User to/from the REC Alert due to change of eligibility criteria shall be based on the Procedure “Entering an ongoing ad hoc group emergency alert” in [TS 23.379] and shall conform to the flows depicted in Figure 33 and Figure 34. (M)

[Editor's Note13] *In this version of the document only the MCPTT part of the “Ad hoc group emergency alert” as specified in [TS 23.379] is considered.*

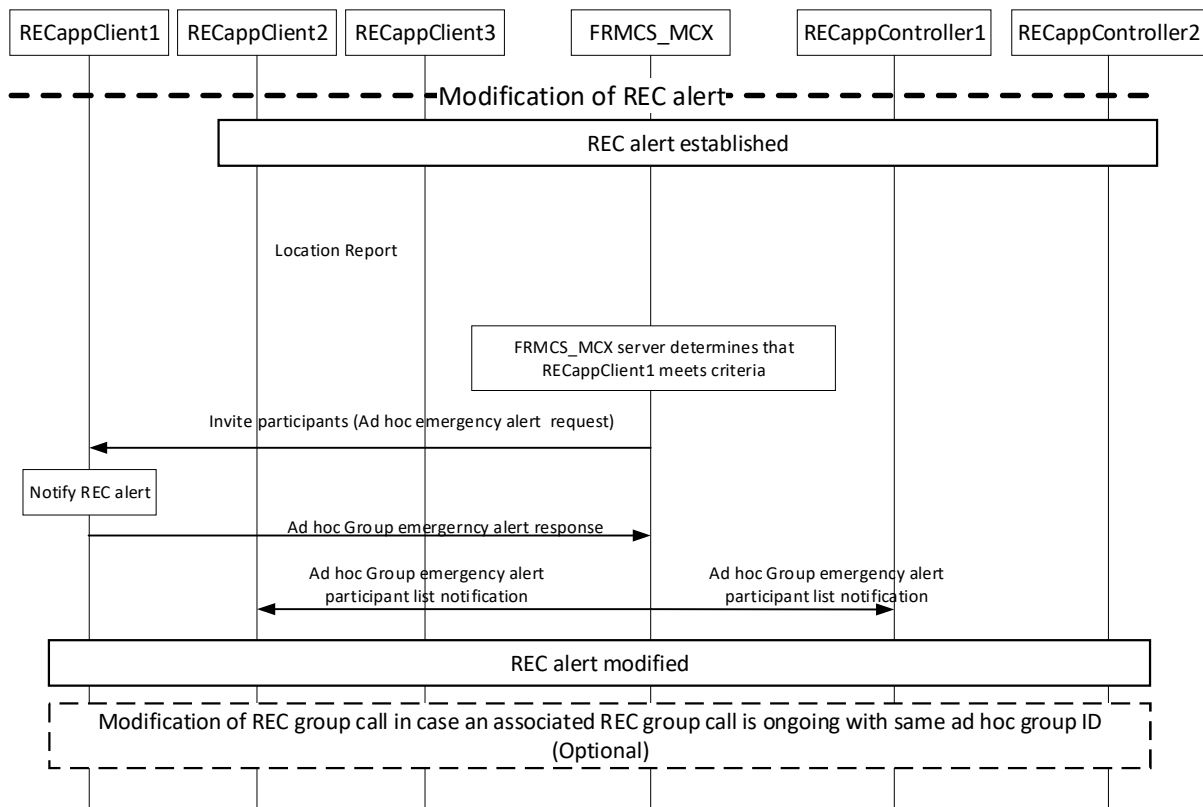

Figure 33: REC alert flow for adding a User based on evaluation of criteria



Flow description:

Part 1: Established REC

4.3.6.7.2. The call related operations depicted in Figure 33 to add a User to the REC Alert due to change of eligibility criteria shall be achieved if, as prerequisite, a REC Alert is established and ongoing area between all participants except RECappClient1. (M)

Part 2: Entry of RECappClient1

4.3.6.7.3. To achieve the call related operations depicted in Figure 33, the FRMCS\_MCX Server shall : (M)

- a) detect eligibility of RECappClient1 to enter REC alert
- b) check the Functional Alias and associated permissions of the client
- c) re-determine the members of the REC alert (based on the above evaluations and the addressed area and Ad hoc group criteria)

Part 3: Update of REC alert

4.3.6.7.4. As the outcome of the call related operations depicted in Figure 33, the REC alert shall be updated and kept ongoing between all determined participants including RECappClient1. (M)

4.3.6.7.5. If there is an associated REC group call ongoing with the same ad hoc group ID as the one used for REC Alert depicted in Figure 33, this REC group call shall be modified accordingly with the same updated participant list. (M)

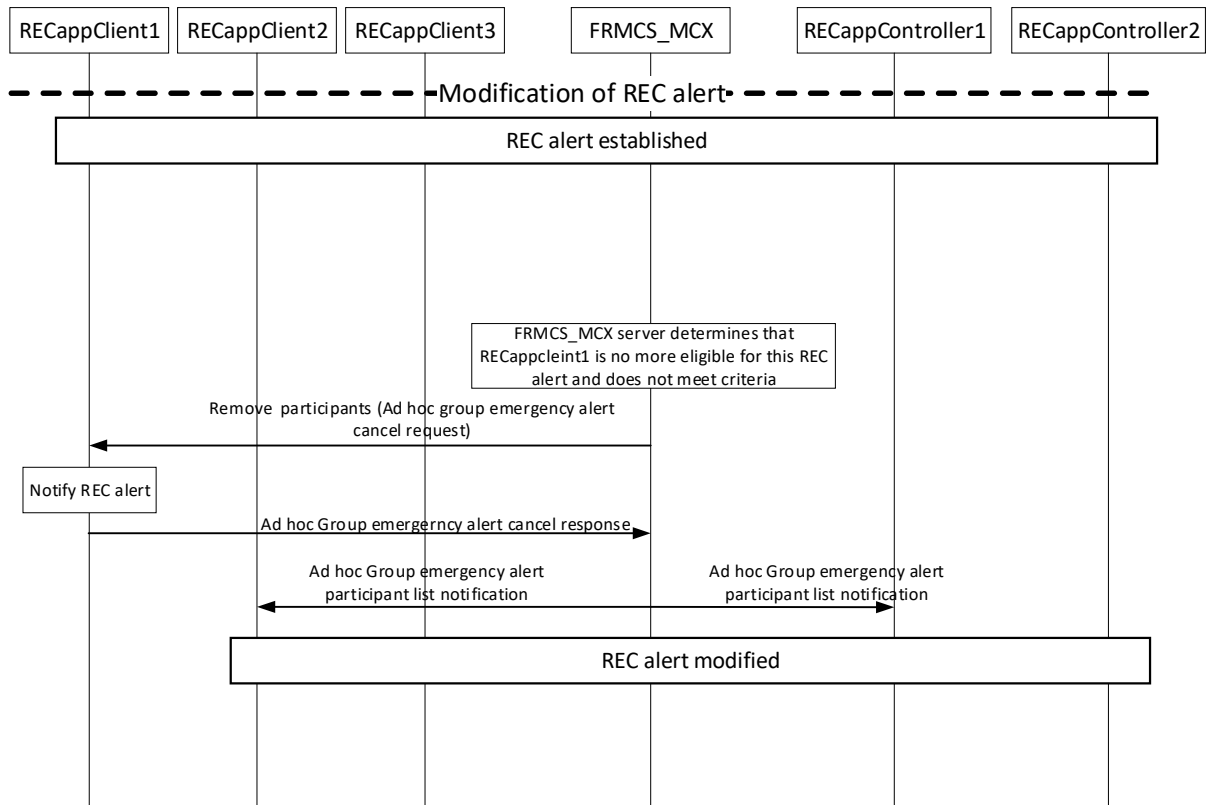

Figure 34: REC alert flow for removing a User based on evaluation of criteria

Flow Description:

Part 1: Established REC alert

4.3.6.7.6. The call related operations depicted in Figure 34 to remove a User from the REC Alert due to change of eligibility criteria shall be achieved if, as prerequisite, a REC Alert is established and ongoing area between all participants including REAppClient1. (M)

Part 2: Removal of REAppClient1

4.3.6.7.7. To achieve the call related operations depicted in Figure 34, the FRMCS\_MCX Server shall : (M)

- a) detects that REAppClient1 is no more eligible for this REC alert because does not meet criteria any more
- b) check the Functional Alias and associated permissions of the moving client
- c) re-determine the members of the REC alert (based on the above evaluations and the addressed area and Ad hoc group criteria)

Part 3: Update of REC alert

4.3.6.7.8. As the outcome of the call related operations depicted in Figure 34, the REC alert shall be updated and kept ongoing between all determined participants excluding REAppClient1. (M)

#### 4.3.6.8. REC-voice communication flow for floor request

4.3.6.8.1. The basic floor request procedure flow for REC-voice shall conform to the flows depicted in Figure 35. (M)

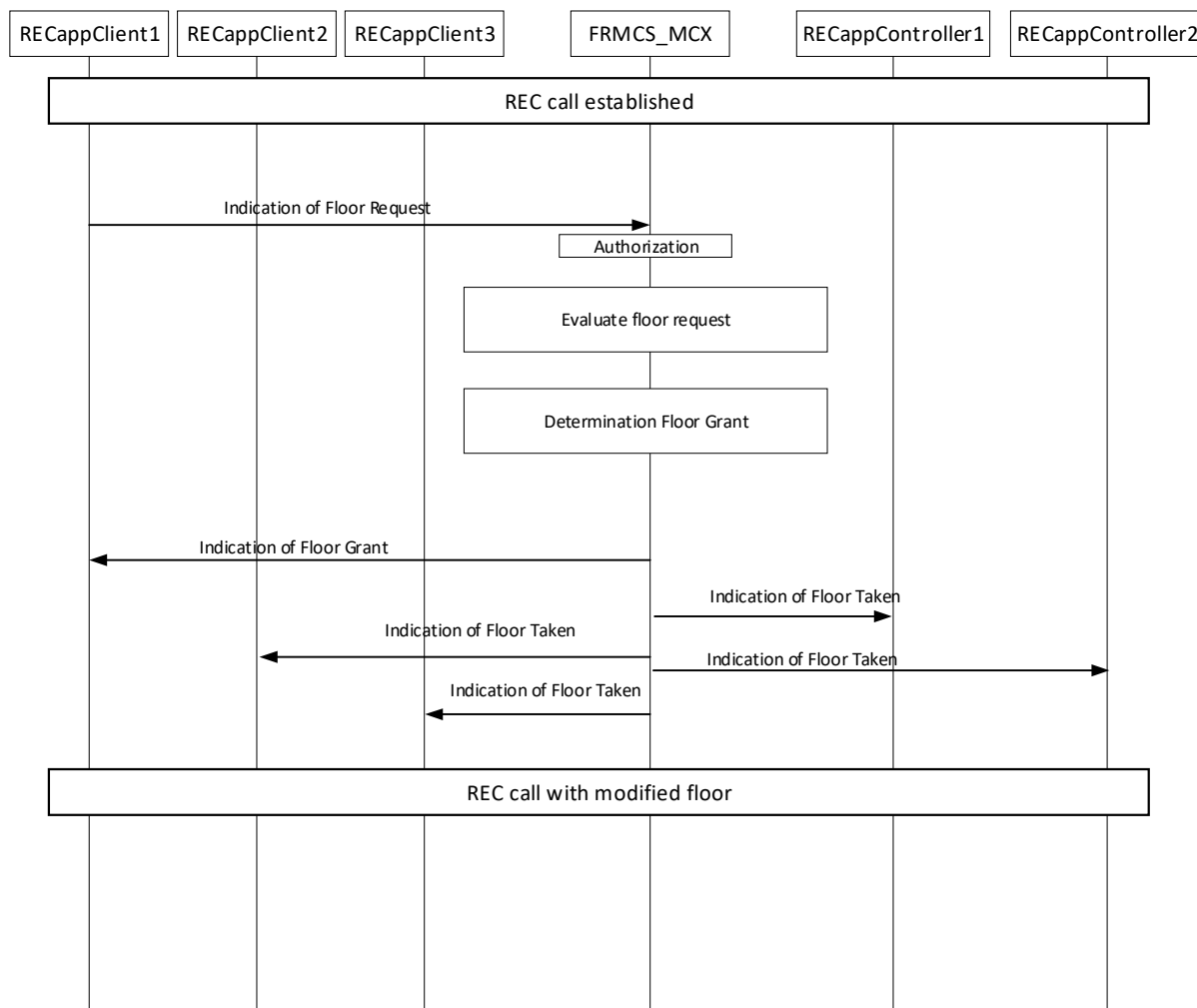

Figure 35: REC-voice communication flow for floor request.

#### 4.3.6.9. Termination of REC

4.3.6.9.1. The termination of a REC alert shall conform to the termination of an emergency alert as specified in section 10.6.2.6.3a of [TS 23.379]. (M)

4.3.6.9.2. If a User leaves an ongoing REC alert/REC voice, the corresponding MCX Client stays in the ongoing ad hoc group communication but the REC will be hidden from the main User interface. (I)

[Editor's Note14] *In this version of the specification, leaving of the REC voice leads systematically to the leaving of the REC alert.*

[Editor's Note15] *In this version of the specification, if a User leaves on ongoing REC alert/REC voice, other participants are not aware because there is no notification mechanism available.*

- 4.3.6.9.3. The MCX Client associated to the REC User having terminated the REC voice shall terminate the related REC alert immediately after completion of the REC voice termination. (M)

[Editor's Note16] *In this version of the specification, termination of REC voice leads systematically to the termination of the REC alert.*

#### 4.3.6.10. Ad hoc Group call criteria definition

- 4.3.6.10.1. The ad hoc group call criteria listed in Table 2 shall be supported for REC alert and REC voice call control as parameter in respective 3GPP ad hoc group emergency alert and 3GPP ad hoc group call information flows as “Criteria for determining the participants”. (M)

- 4.3.6.10.2. The ad hoc group call criteria shall be inserted as a <call-participants-criterias> with one or more criteria as a comma separated list into <anyExt> element of <mcptt-Params> element of <mcpttinfo> element of the application/vnd.3gpp.mcptt-info+xml MIME body in the SIP INVITE request, as per [TS 24.379]. (M)

- 4.3.6.10.3. The comma separated list shall be of the following format: criteria\_name\_1="Value\_1", criteria\_name\_2="Value\_2",..., criteria\_name\_n="Value\_n". For example FRMCS\_CallType="FRMCS\_CT\_REC", FRMCS\_UseAdressedArea="True". (M)

- 4.3.6.10.4. The set of criteria to use is depending on the use case. (I)

ad hoc group call criteria name	ad hoc group call criteria parameter	Usage by Initiator (Driver)	Usage by Initiator (Controller)	Usage by FRMCS Server	Description	Category
FRMCS_CallType		(R) Initiation Message	(R) Initiation Message	Evaluation upon reception of initiation message	Definition of Adhoc Call Type For REC the FRMCS_CallType shall be FRMCS_CT_REC	M
FRMCS_UseInitiatingArea (Boolean)	N/A	N/A	Initiation Message	Evaluation upon reception of initiation message	Service Server takes Initiating Area into account instead of server based addressing area definition Usage of this parameter requires to have the FRMCS_ListOfInitiatingArea criteria to be present.	M-Vx
FRMCS_ListOfInitiatingArea	Area_1; Area_2; ...	N/A	Initiation Message	Evaluation upon reception	List of Initiating Areas the server takes into account for evaluation.	M-Vx

(List of Areas)	Area_n		from Controller	of initiation message	The server shall take the union of all Initiating Areas into account  Area_x shall be an area name (equal on Location Label)	
FRMCS_UseAddressedArea (Boolean)	N/A	N/A	Initiation Message	Evaluation upon reception of initiation message	Service Server shall take addressed area into account instead of server based addressing area definition Usage of this parameter requires to have either the FRMCS_ListOfAddressedArea or the FRMCS_AddressAreaPolygon criteria to be present.	M
FRMCS_ListOfAddressedArea (List of Areas)	Area_1; Area_2; ... Area_n	N/A	Initiation Message from Controller	Evaluation upon reception of initiation message	List of Addressed areas the server shall take into account for evaluation. The server shall take the union of all Addressed Areas into account  Area_x can shall be an area name (equal to Location Label)	M for single area M-Vx for multiple area Area
FRMCS_AddressAreaPolygon	AreaPolygon;	N/A	Initiation Message from Controller	Evaluation upon reception of initiation message	Addressed area the server takes into account for evaluation.  Area_x is a polygon definition  In case of polygon definition, the addressed controllers shall be all the controllers associated to the predefined addressed areas fully or partially included in the manually defined area.	M-Vx
FRMCS_TargetParticipantList (List of FAs)	FA1; FA2; ... FA_n	N/A	Initiation Message	Evaluation upon reception of initiation message	List of target FAs the communication is addressed to.  Definition is generic to allow also multiple target participant list. Then the addressed area would be union of all addressed FAs.	M-Vx
FRMCS_UseRailwayInfrastructureLocation (List of Location Parameters)	Param_1; Param_2;	N/A	N/A	Evaluation upon reception of initiation message	Use railway infrastructure for location,  Criteria is used as vehicle to transport non standard location information which is not covered by MCX Location reporting	M-Vx

Table 2: List of criteria for ad hoc group call and ad hoc emergency alert

Legend:

R	Criteria is always required
---	-----------------------------

4.3.6.10.5. Combined REC alert and REC voice shall use the same criteria for REC alert part and associated REC voice part. (M)

4.3.6.10.6. Combined REC alert and REC data shall use the same criteria for REC alert part and associated REC data part. (M-Vx)

#### 4.3.6.11. Ad hoc Group call server based parameter definition

4.3.6.11.1. The following list of parameters shall be supported for REC alert and REC voice call control as parameter used in FRMCS service server for call control functionality. (M)

Parameter name	Additional parameter	Description	Category
FRMCS_PredefinedParticipants PerAdressedArea (Datatype <TBD>)	Area_1: Participant_1; Participant_2; Participant_n;  Area_2: Participant_1; Participant_2; Participant_n;  Area_n:	Predefined User(s) for the addressed area, such as controller(s).	M
FRMCS_PredefinedRECvoice PerFunctionalLabel (Datatype <TBD>)	FunctionalLabelRule 1: NoAutomaticRECVoice   AutomaticRECVoice  FunctionalLabelRule 2: NoAutomaticRECVoice   AutomaticRECVoice		M-Vx
FRMCS_PredefinedRECvoice PerTargetArea (Datatype <TBD>)	InitiatingArea 1: NoAutomaticRECVoice   AutomaticRECVoice  InitiatingArea 2: NoAutomaticRECVoice   AutomaticRECVoice		M-Vx
FRMCS_ExcludeParticipants DifferentRoute (Datatype <TBD>)	Route_1; Route_2; Route_n;	Serverexcludes participants having a route not concerned by the emergency situation	M-Vx
FRMCS_ExcludeParticipants DifferentSpeed (Boolean)	SpeedCriteria (TBD)	Server excludes participants not matching speed criteria.	M-Vx
FRMCS_ExcludeParticipants DifferentDirection (Boolean)	-	Server excludes participants not driving in the direction of the emergency location	M-Vx

Table 3: List of parameters used in FRMCS service server for call control functionality

#### 4.3.7. Additional REC requirements

4.3.7.1.1. The MCX mechanism for ad hoc group emergency alert participant list notification shall be used to inform the controller about the recipients of the REC alert. (M-V3)

[Editor's Note17] *For FRMCS V2, ad hoc group emergency alert participant list notification is not essential as REC voice is always set up when REC alert is initiated.*

- 4.3.7.1.2. The MCX mechanism for ad hoc group call participant list notification shall be used to inform the controller about the recipients of the REC voice. (M)

#### 4.3.8. Floor Control requirements

- 4.3.8.1.1. The REC-voice floor control mechanism shall be based on the defined mechanism for floor control for Ad hoc group calls as defined in [TS 23.379] and [TS 24.380]. (M)
- 4.3.8.1.2. The REC-voice floor control mechanism shall determine the floor priority as per effective floor priority determination defined in [TS 24.380] Chapter 4.1.1.4. (M)
- 4.3.8.1.3. The floor priority for dispatcher Users shall be always higher than for other REC-voice participants, using a defined higher floor priority number in the Floor Request message. (M)
- 4.3.8.1.4. The floor priority for dispatcher Users shall be pre-emptive such as the current talker is overridden. (M)

[Editor's Note18] *In this version of the document single user talker control is defined (only a single user is allowed to talk).*

- 4.3.8.1.5. The floor priority for non-dispatcher Users shall use a floor-priority defined by configuration, lower than dispatcher User floor-priority. (M)
- 4.3.8.1.6. The floor priority scheme defined in [FRMCS SRS] shall be used by the participants. (M-V3)

[Editor's Note19] *The expected floor priority scheme for REC should be reflected in FRS in the next version.*

## 4.4. Voice communications

### 4.4.1. Introduction

- 4.4.1.1.1. Voice communication is specified according to the requirements of the applicable sub-sections of section 10 in [FRMCS FRS]. (I)

### 4.4.2. Voice communication User Registration and Role Management

- 4.4.2.1.1. The MCX Client associated to a voice communication user shall comply to the requirements specified in section 2.2.2 of this document. (M)
- 4.4.2.1.2. The MCX Client associated to a voice communication user shall comply to the requirements specified in section 3.1.2.3 of this document in order to perform voice communication. (M)
- 4.4.2.1.3. A voice communication shall activate functional identities in the FRMCS System in accordance with the requirements specified by section 3.1.3 of this document in order to perform voice communication for which functional identity(ies) registration is a prerequisite. (M-V3)

[Editor's Note <sup>20</sup> ] <i>Except for REC, it is not yet clarified which FRMCS Applications will require as prerequisite to activate a Functional Alias.</i>
---

### 4.4.3. Voice communication principles

- 4.4.3.1.1. The onboard voice communication application uses the Tight-Coupled mode as described in section 1.4 of this document. (I)
- 4.4.3.1.2. The trackside voice communication application uses the Tight-Coupled mode as described in section 1.4 of this document or the TSCtrl interface as specified in [FRMCS SRS]. (I)
- 4.4.3.1.3. The call flows of a voice communication based on ad hoc group call shall use related Stage-2 procedures using “on-demand” Session in [TS 23.379]. (M)
- 4.4.3.1.4. The call flows of a voice communication based on ad hoc group call shall use related Stage-3 procedures using “on-demand” Session in [TS 24.379]. (M)
- 4.4.3.1.5. The call flows of a voice communication based on private call shall be aligned with the private call functional specification in [TS 23.379]. (M)
- 4.4.3.1.6. The call flows of a voice communication based on private call shall be aligned with the private call protocol specification in [TS 24.379]. (M)



#### 4.4.4. QoS and priority

- 4.4.4.1.1. The voice communication application uses the QoS and priority parameters according to section 10 of [FRMCS FRS] and section 14 in [FRMCS SRS]. (I)
- 4.4.4.1.1i The MCX Client associated with the voice communication application shall request the QoS and priority level as specified within [TS 103 765-1]. (M)
- 4.4.4.1.2. The MCX Client associated with the voice communication application shall be able to provide the requested application priority as specified within section 3.3. (M-V3)
- 4.4.4.1.3. The MCX Server is responsible for the determination of the appropriate QoS and for the propagation to the transport layer (see [FRMCS SRS] for details about QoS and priority). (I)

#### 4.4.5. Voice communication flows

##### 4.4.5.1. Message flow for voice communication from driver towards the controller(s)

- 4.4.5.1.1. The message flow for voice communication from driver towards the controller(s) shall conform to the flows depicted in Figure 36. (M)

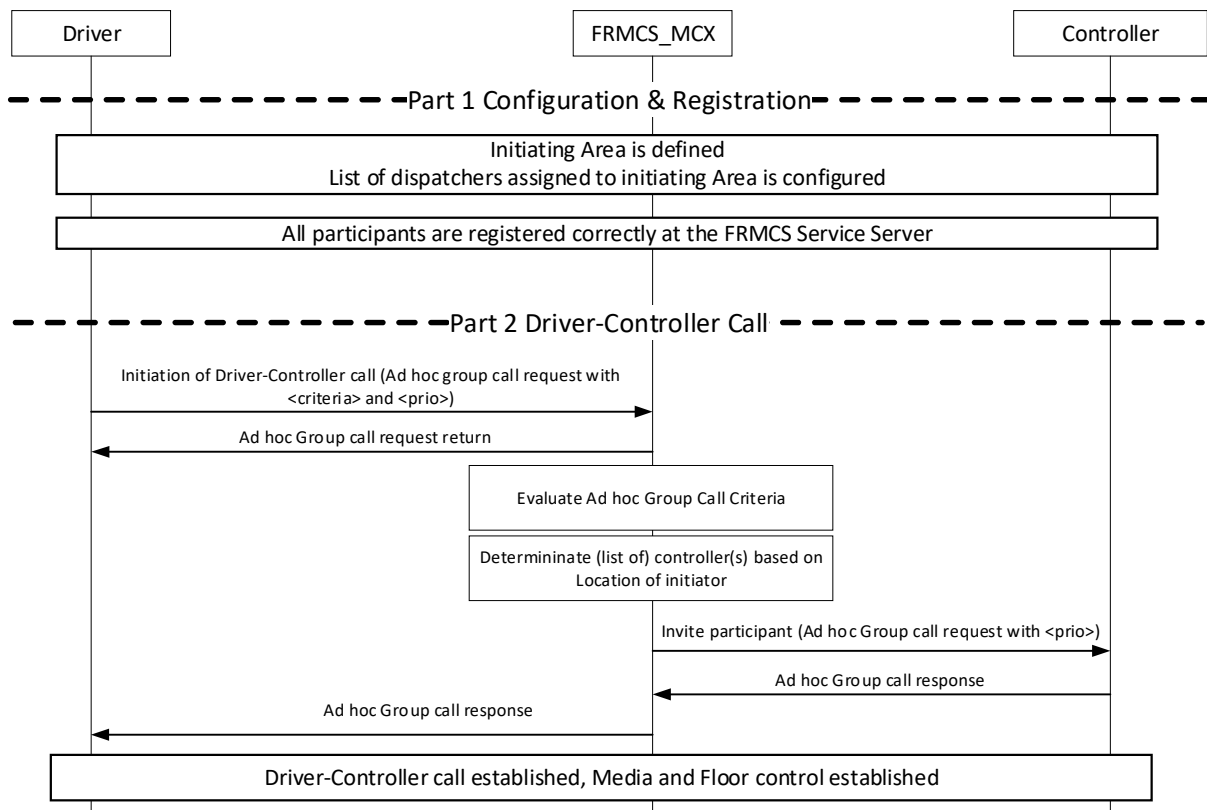

Figure 36: Driver to controller voice communication flow

Flow Description:

- 4.4.5.1.2. The call related operations depicted in Figure 36 to initiate a voice communication from driver towards controller(s) shall be achieved if, as prerequisite, the following conditions are fulfilled: (M)
- a) Initiating Area is configured
  - b) Controller(s) identity(ies) associated to Initiating Area is(are) configured
  - d) All clients participating in communication Sessions are registered correctly at the FRMCS Service Server
  - e) Controller(s) is(are) registered as controller identity
  - f) Roles (Functional Alias) have been registered accordingly by all participants
- 4.4.5.1.3. As depicted in Figure 36, a driver shall initiate the driver-to-controller communication as an Ad hoc group call with the following specific criteria parameters included: (M)
- a) FRMCS\_UseInitiatorLocation
  - b) FRMCS\_CallType
- 4.4.5.1.4. For the initiation of the driver-to-controller communication, depending on the type of communication (normal or urgent see

[FRMCS FRS] for details), the criteria FRMCS\_CallType shall be set to : (M)

- a) "FRMCS\_CT\_DRIVER2CONTROLLER\_NORMAL" or
- b) "FRMCS\_CT\_DRIVER2CONTROLLER\_URGENT".

4.4.5.1.5. The functional alias of the initiator of the driver-to-controller communication shall be provided as "functional alias of the calling party" as per information element "functional alias" in Ad hoc group call request in [TS 23.379] Table 10.19.2.1-1. (M)

4.4.5.1.6. To achieve the call related operation depicted in Figure 36, the FRMCS\_MCX Server shall: (M)

- a) evaluate the Ad hoc Group Call criteria
- b) determine the (list of) controller(s) based on the Initiating Area and available predefined definitions for this Initiating Area (e.g. responsible controllers)
- c) invite the determined controller(s) to the Ad hoc Group call with the appropriate communication priority (see [FRMCS FRS] and [FRMCS SRS]) and establishes the respective media and floor control

4.4.5.1.7. As the outcome of the call related operations depicted in Figure 36, the driver-to-controller communication shall be established and kept ongoing between all determined participants. (M)

#### 4.4.5.2. Message flow for voice communication from controller towards driver

4.4.5.2.1. The message flow for voice communication from controller towards driver shall conform to the flows depicted in Figure 37. (M)

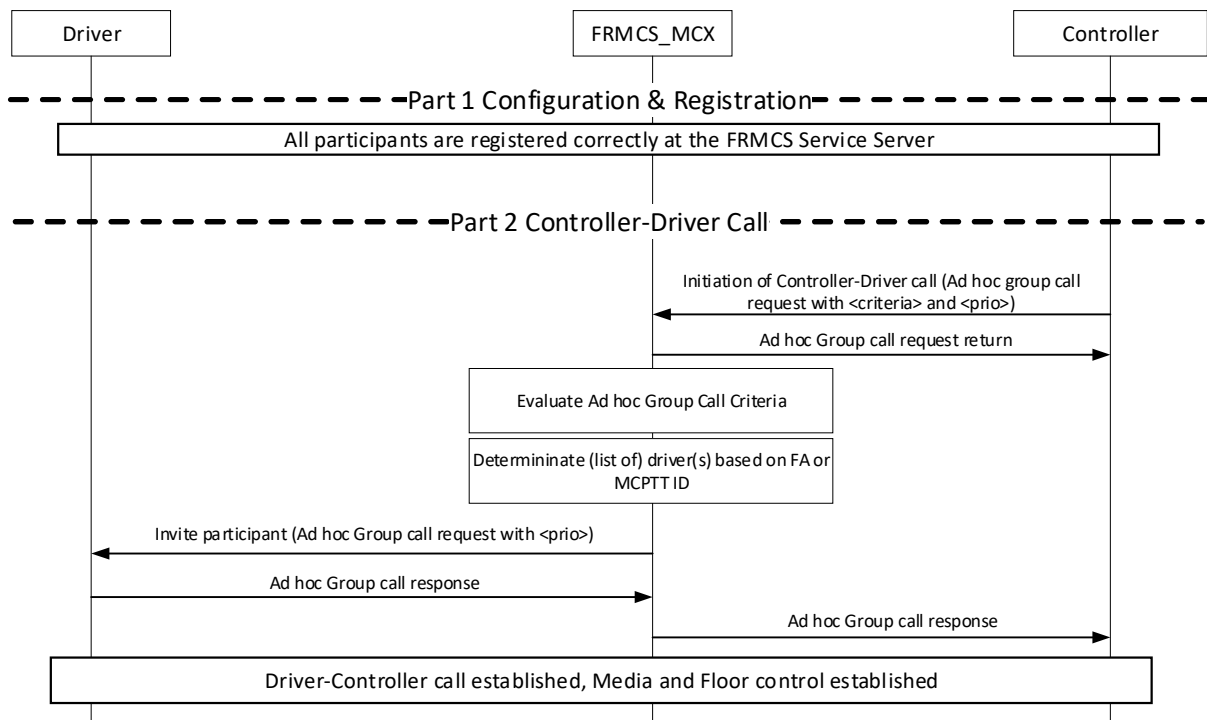

Figure 37: Controller to driver voice communication flow

#### Flow Description:

- 4.4.5.2.2. The call related operations depicted in Figure 37 to initiate a voice communication from controller towards driver shall be achieved if, as prerequisite, the following conditions are fulfilled: (M)
- a) All clients participating in communication Sessions are registered correctly at the FRMCS Service Server
  - b) Controller is registered as controller identity
  - c) Roles (Functional Alias) have been registered accordingly by all participants
- 4.4.5.2.3. As depicted in Figure 37, a controller shall initiate the controller-to-driver communication as an Ad hoc group call with the following specific criteria parameters included: (M)
- a) FRMCS\_TargetParticipantFA and/or FRMCS\_TargetParticipantUserId
  - b) FRMCS\_CallType
- 4.4.5.2.4. For the initiation of the controller-to-driver communication, the criteria FRMCS\_CallType shall be set to FRMCS\_CT\_CONTROLLER2DRIVER\_NORMAL. (M)
- 4.4.5.2.5. The functional alias of the initiator of the controller-to-driver communication shall be provided as "functional alias of the calling party" as per information element "functional alias" in Ad hoc group call request in [TS 23.379] Table 10.19.2.1-1. (M)

- 4.4.5.2.6. To achieve the call related operation depicted in Figure 37, the FRMCS\_MCX Server shall: (M)
- a) evaluate the Ad hoc Group Call criteria
  - b) determine the (list of) driver(s) based on the Functional Alias(es) or MCPTT User ID(s) which was(were) included in the setup message
  - c) invite the determined driver(s) to the Ad hoc Group call, with the appropriate communication priority – as specified in [FRMCS FRS] and [FRMCS SRS] – and establishes the respective media and floor control

4.4.5.2.7. As the outcome of the call related operations depicted in Figure 37, the controller-to-driver communication shall be established and kept ongoing between all determined participants. (M)

#### 4.4.5.3. Message flow for multi-train voice communication initiated by Driver

4.4.5.3.1. The message flow for multi-train voice communication initiated by driver shall conform to the flows depicted in Figure 38. (M)

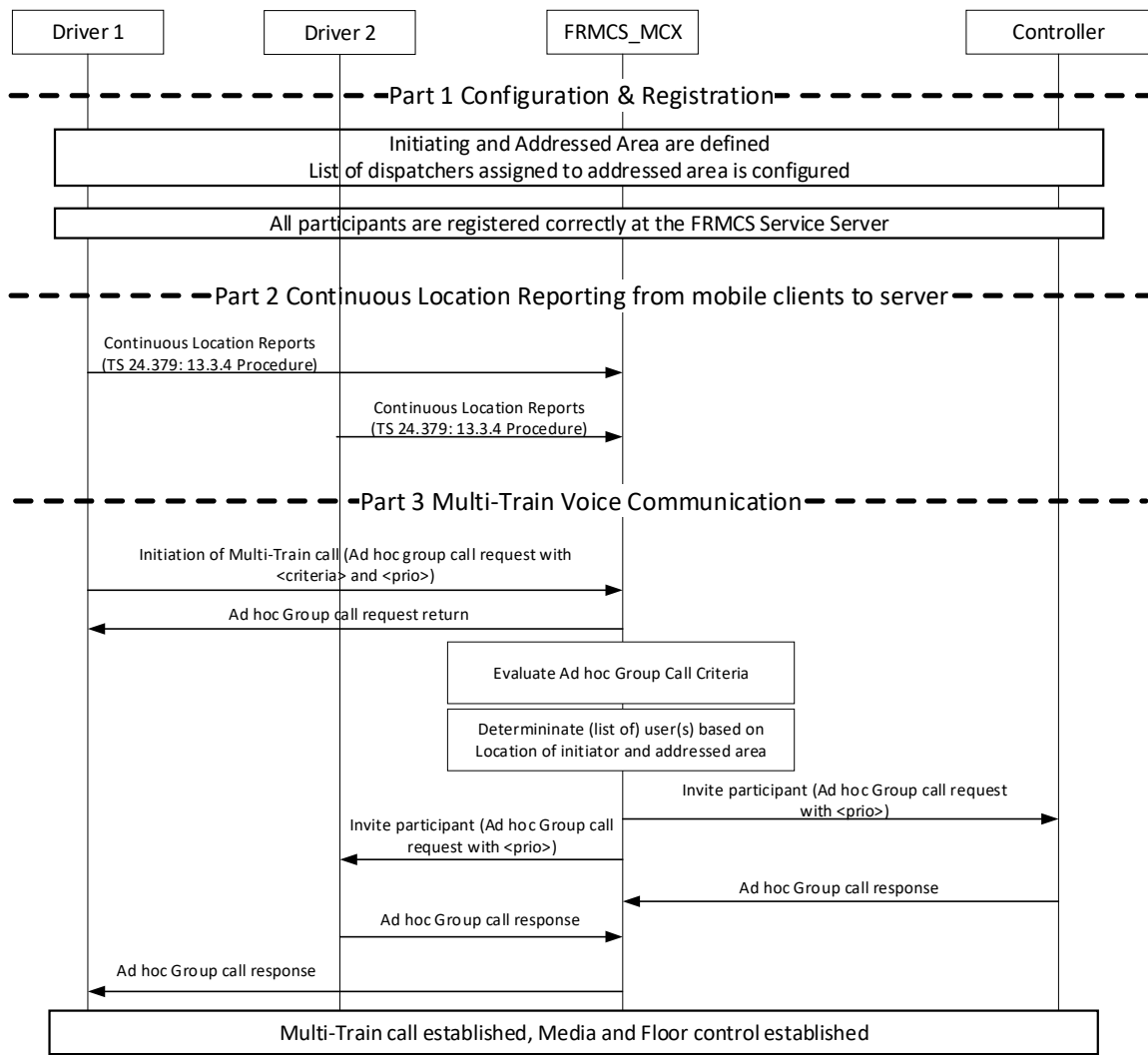

Figure 38: Multi-Train voice communication initiated by driver communication flow

Flow Description:

4.4.5.3.2. The call related operations depicted in Figure 38 to initiate a multi-train voice communication initiated by driver shall be achieved if, as prerequisite, the following conditions are fulfilled: (M)

- a) Initiating and addressed area are configured
- b) Controllers identities associated to addressed area are configured
- c) All clients participating in communication Sessions are registered correctly at the FRMCS Service Server
- d) Controller is registered as controller identity
- e) Roles (Functional Alias) are registered accordingly by all participants
- f) Location information related to the MCX Clients of the mobile Users received through location reports as defined in section 3.2.2 is available.

- 4.4.5.3.3. As depicted in Figure 38, a driver shall initiate a multi-train voice communication as an Ad hoc group call with the following specific criteria parameters included: (M)
- a) FRMCS UseInitiatorLocation
  - b) FRMCS CallType
- 4.4.5.3.4. For the initiation of the multi-train voice communication initiated by driver, depending on the type of communication (normal or urgent see [FRMCS FRS] for details), the criteria FRMCS\_CallType shall be set to : (M)
- a) FRMCS\_CT\_MULTITRAIN\_NORMAL or
  - b) FRMCS\_CT\_MULTITRAIN\_URGENT
- 4.4.5.3.5. The functional alias of the initiator of the multi-train voice communication shall be provided as "functional alias of the calling party" as per information element "functional alias" in Ad hoc group call request in [TS 23.379] Table 10.19.2.1-1. (M)
- 4.4.5.3.6. To achieve the call related operation depicted in Figure 38, the FRMCS\_MCX Server shall: (M)
- a) evaluate the Ad hoc Group Call criteria
  - b) determine the addressed area using the Initiating Area
  - c) determine the (list of) controller(s) and driver(s) based on the addressed area, and available predefined definitions for this addressed area (e.g. responsible controllers)
  - d) The FRMCS\_MCX Server invites the determined controller(s) and driver(s) to the Ad hoc Group call, with the appropriate communication priority – as specified in [FRMCS FRS] and [FRMCS SRS] – and establishes the respective media and floor control
- 4.4.5.3.7. As the outcome of the call related operations depicted in Figure 38, the multi-train voice communication initiated by driver shall be established and kept ongoing between all determined participants. (M)

#### 4.4.5.4. Message flow for multi-train voice communication initiated by controller

- 4.4.5.4.1. The message flow for multi-train voice communication initiated by controller shall conform to the flows depicted in Figure 39. (M)

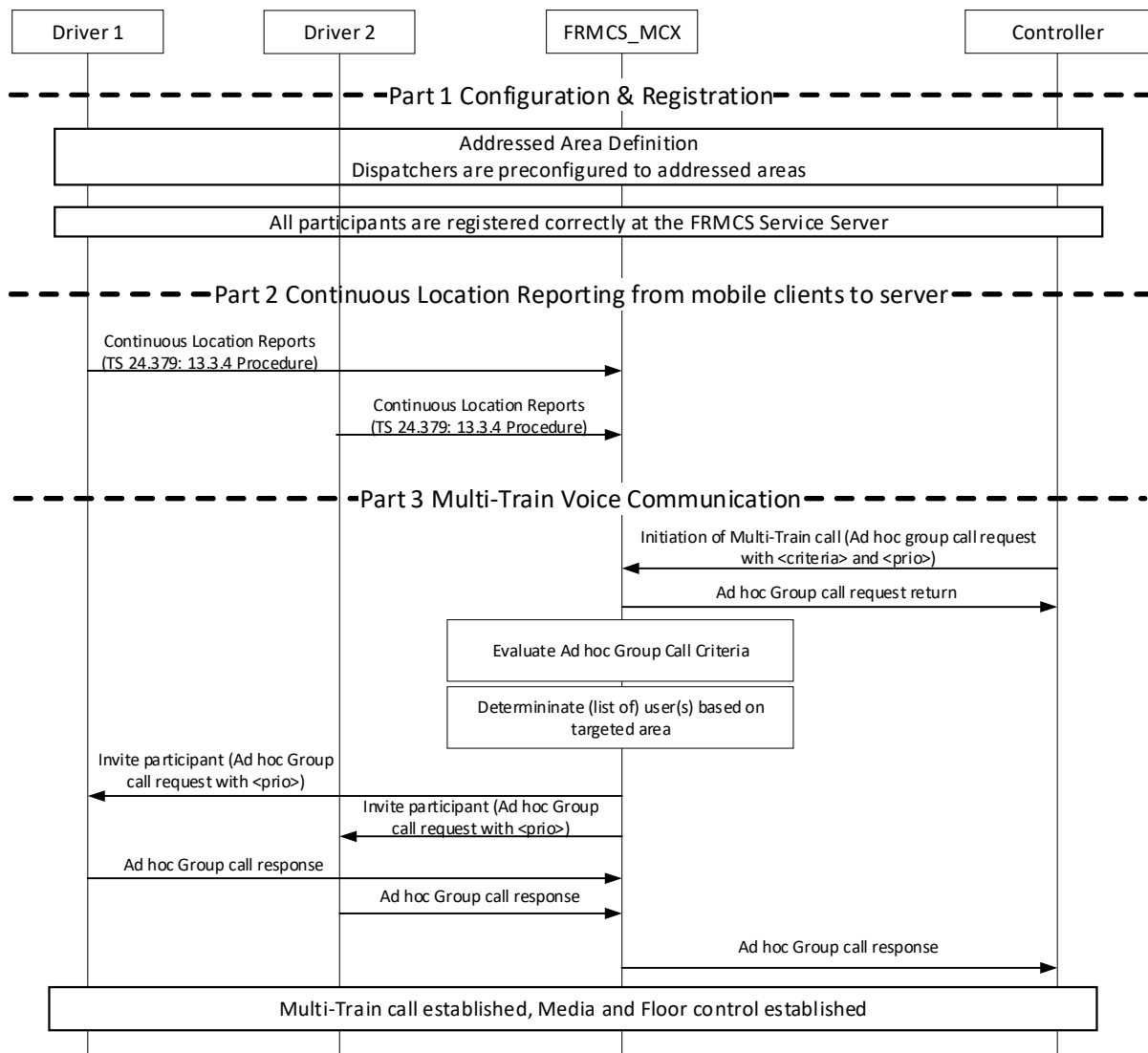

Figure 39: Multi-Train voice communication initiated by controller communication flow

#### Flow Description:

4.4.5.4.2. The call related operations depicted in Figure 39 to initiate a voice communication from driver towards controller(s) shall be achieved if, as prerequisite, the following conditions are fulfilled:

(M)

- a) Initiating and addressed area are configured
- b) Controllers identities associated to addressed area are configured
- c) All clients which participating in communication Sessions area registered correctly at the FRMCS Service Server
- d) Controller(s) is(area) registered as controller identity(ies)
- e) Roles (Functional Alias) are registered accordingly by all participants
- f) Location information related to the MCX Clients of the mobile Users received through location reports as defined in section 3.2.2 is available.



- 4.4.5.4.3. As depicted in Figure 39, a controller shall initiate a multi-train voice communication as an Ad hoc group call with the following specific criteria parameters included: (M)
- a) FRMCS\_ListOfAddressedArea
  - b) FRMCS\_CallType
- 4.4.5.4.4. For the initiation of the multi-train voice communication initiated by controller, depending on the type of communication (normal or urgent see [FRMCS FRS] for details), the criteria FRMCS\_CallType shall be set to: (M)
- a) FRMCS\_CT\_MULTITRAIN\_NORMAL or
  - b) FRMCS\_CT\_MULTITRAIN\_URGENT
- 4.4.5.4.5. The functional alias of the initiator of the multi-train voice communication shall be provided as "functional alias of the calling party" as per information element "functional alias" in Ad hoc group call request in [TS 23.379] Table 10.19.2.1-1. (M)
- 4.4.5.4.6. To achieve the call related operation depicted in Figure 39, the FRMCS\_MCX Server shall: (M)
- a) evaluate the Ad hoc Group Call criteria
  - b) determine the (list of) controller(s) and driver(s) based on the addressed area, and available predefined definitions for this addressed area (e.g. responsible controllers)
  - c) invite the determined controller(s) and driver(s) to the Ad hoc Group call, with the appropriate communication priority – as specified in [FRMCS FRS] and [FRMCS SRS] – and establishes the respective media and floor control
- 4.4.5.4.7. As the outcome of the call related operations depicted in Figure 39, the multi-train voice communication initiated by controller shall be established and kept ongoing between all determined participants. (M)

#### 4.4.5.5. Message flow for controller to controller(s) voice communication using ad-hoc group call

- 4.4.5.5.1. The message flow for controller-to-controller(s) voice communication using ad-hoc group call shall conform to the flows depicted in Figure 40. (M)

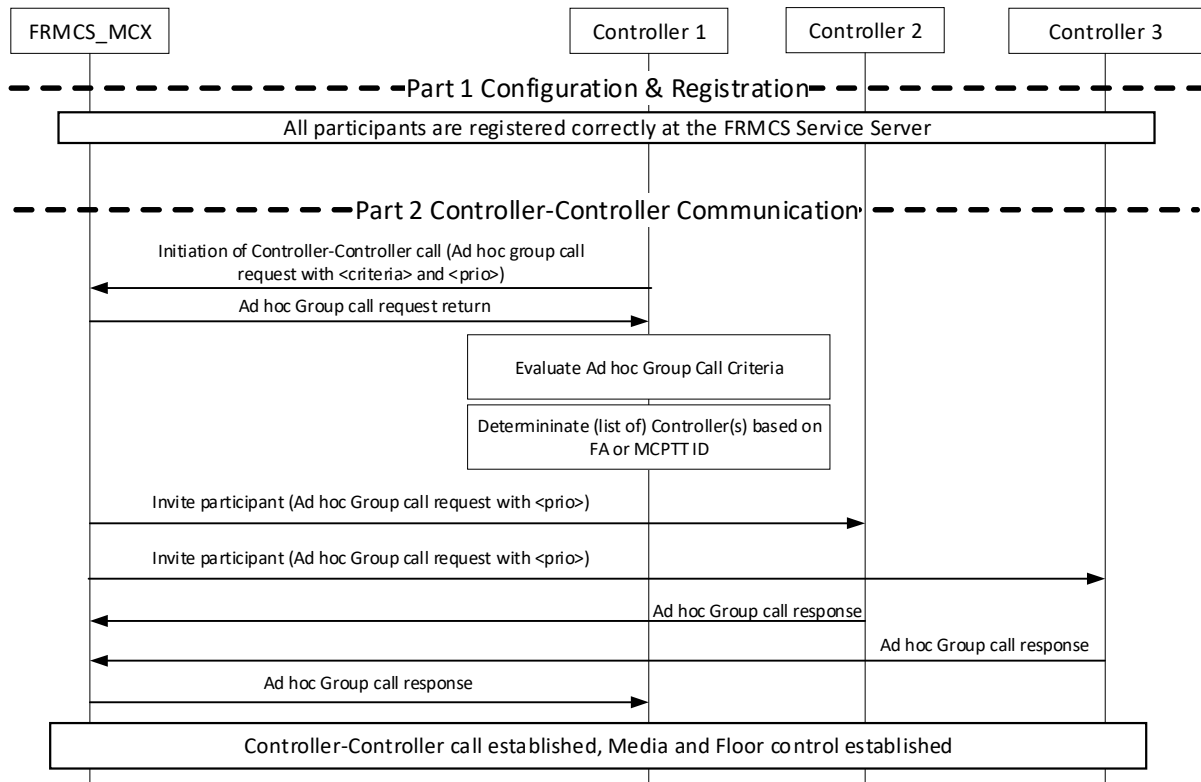

Figure 40: Controller-to-controller(s) voice communication using ad hoc group call flow

#### Flow Description:

- 4.4.5.5.2. The call related operations depicted in Figure 40 to initiate a controller-to-controller(s) voice communication using ad-hoc group call shall be achieved if, as prerequisite, the following conditions are fulfilled: (M)
- a) All clients participating in communication Sessions shall be registered correctly at the FRMCS Service Server
  - b) Controller is registered as controller identity
  - c) Roles (Functional Alias) are registered accordingly by all participants
- 4.4.5.5.3. As depicted in Figure 40, a controller shall initiate a controller-to-controller communication using ad-hoc group call as an Ad hoc group call with the following specific criteria parameters included: (M)
- a) FRMCS\_TargetParticipantFA and/or FRMCS\_TargetParticipantUserld
  - b) FRMCS\_CallType
- 4.4.5.5.4. For the initiation of the controller-to-controller communication using ad-hoc group call, the criteria FRMCS\_CallType shall be set to FRMCS\_CT\_CONTROLLER2CONTROLLER\_NORMAL. (M)

- 4.4.5.5.5. To achieve the call related operation depicted in Figure 40, the FRMCS\_MCX Server shall: (M)
- a) evaluate the Ad hoc Group Call criteria
  - b) determines the (list of) controller(s) based on the Functional Alias and/or MCPTT User ID which was included in the setup message
  - c) invite the determined controllers to the Ad hoc Group call, with the appropriate communication priority – as specified in [FRMCS FRS] and [FRMCS SRS] – and establishes the respective media and floor control

- 4.4.5.5.6. As the outcome of the call related operations depicted in Figure 40, the controller-to-controller communication using ad-hoc group call shall be established and kept ongoing between all determined participants. (M)

#### 4.4.5.6. Message flow for controller to controller voice communication using private call

- 4.4.5.6.1. The FRMCS system shall support the use of private call according to [TS 23.379], figure 10.7.2.2.1-1 for controller to controller voice communication. (M-Vx)

#### 4.4.5.7. Message flow for leaving an ad-hoc group call

- 4.4.5.7.1. If a User leaves an ongoing ad-hoc group call, the corresponding MCX Client stays in this communication but the call will be hidden from the main user interface. (I)

[Editor's Note21] *In this version of the specification, if a User leaves an ongoing voice call, other participants are not aware because there is no notification mechanism available.*

#### 4.4.5.8. Message flow for adding a participant to an on-going ad-hoc group call

- 4.4.5.8.1. The message flow for adding a participant to an on-going ad-hoc group call shall conform to the flows depicted in Figure 41. (M)

[Editor's Note22] *In this version of the specification (based on 3GPP Rel 18), only an authorized User of an ad-hoc group call can modify this call later on, using the Stage-2 procedure specified in [TS 23.379] §10.19.3.1.6 (Modification of ad hoc group call criteria by an authorized User).*

[Editor's Note23] *The related Stage-3 procedure using “on-demand” Session in [TS 24.379] will be referenced in a next version of this document because it is not yet defined.*

[Editor's Note24] *The procedures for removal of a participant from an on-going ad-hoc group call are similar to the ones for adding a participant to an on-going ad-hoc group call.*

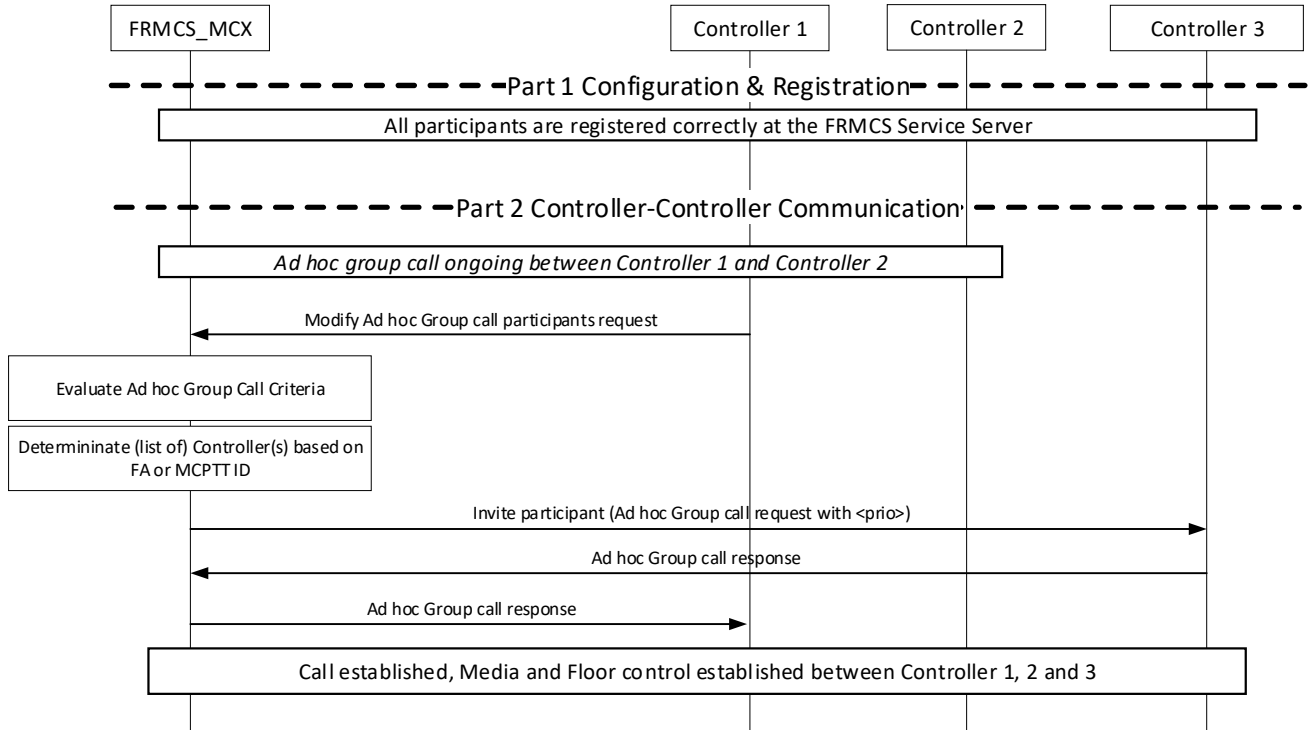

Figure 41: Adding a participant to an on-going ad-hoc group call

#### Flow Description:

4.4.5.8.2. The call related operations depicted in Figure 41 to add a participant to an ongoing ad-hoc group call shall be achieved if, as prerequisite, the following conditions are fulfilled: (M)

- a) All clients participating in communication Sessions are registered correctly at the FRMCS Service Server
- b) Controller is registered as controller identity
- c) Roles (Functional Alias) are registered accordingly by all participants
- d) An Ad hoc group call is established and on-going between Controller 1 and Controller 2
- e) Authorization for Controller1 to add a participant is configured

4.4.5.8.3. As depicted in Figure 41, Controller1 shall include Controller 3 in the ongoing ad-hoc group call by modifying the following specific criteria parameters: (M)

- a) FRMCS\_TargetParticipantFA or
- b) FRMCS\_TargetParticipantUserId

- 4.4.5.8.4. To achieve the call related operations as depicted in Figure 41, the updated version of the criteria shall include identity of Controller 3 and the identity of Controller 2. (M)
- 4.4.5.8.5. To achieve the call related operation depicted in Figure 41, the FRMCS\_MCX Server shall: (M)
- a) evaluate the Ad hoc Group Call criteria
  - b) determines the (list of) controller(s) and/or driver(s) based on the criteria.
  - c) invite all the new participants as requested by Controller 1 to the Ad hoc Group call, with the correct communication priority and establishes the respective media and floor control
- 4.4.5.8.6. As the outcome of the call related operations depicted in Figure 41, the Ad hoc group call shall be kept ongoing and shall include the participants defined in the updated criteria parameters. (M)

#### 4.4.5.9. Message flow for pseudo-merging of two on-going voice communication

- 4.4.5.9.1. The message flow for pseudo-merging of two voice communications between controllers using ad-hoc group call shall conform to the flows depicted in Figure 42. (M-V3)

<p>[Editor's Note25] <i>The actual merging of two on-going voice communications is not included in this version of the specification, as this functionality will only be supported in 3GPP Rel 20.</i></p>
--

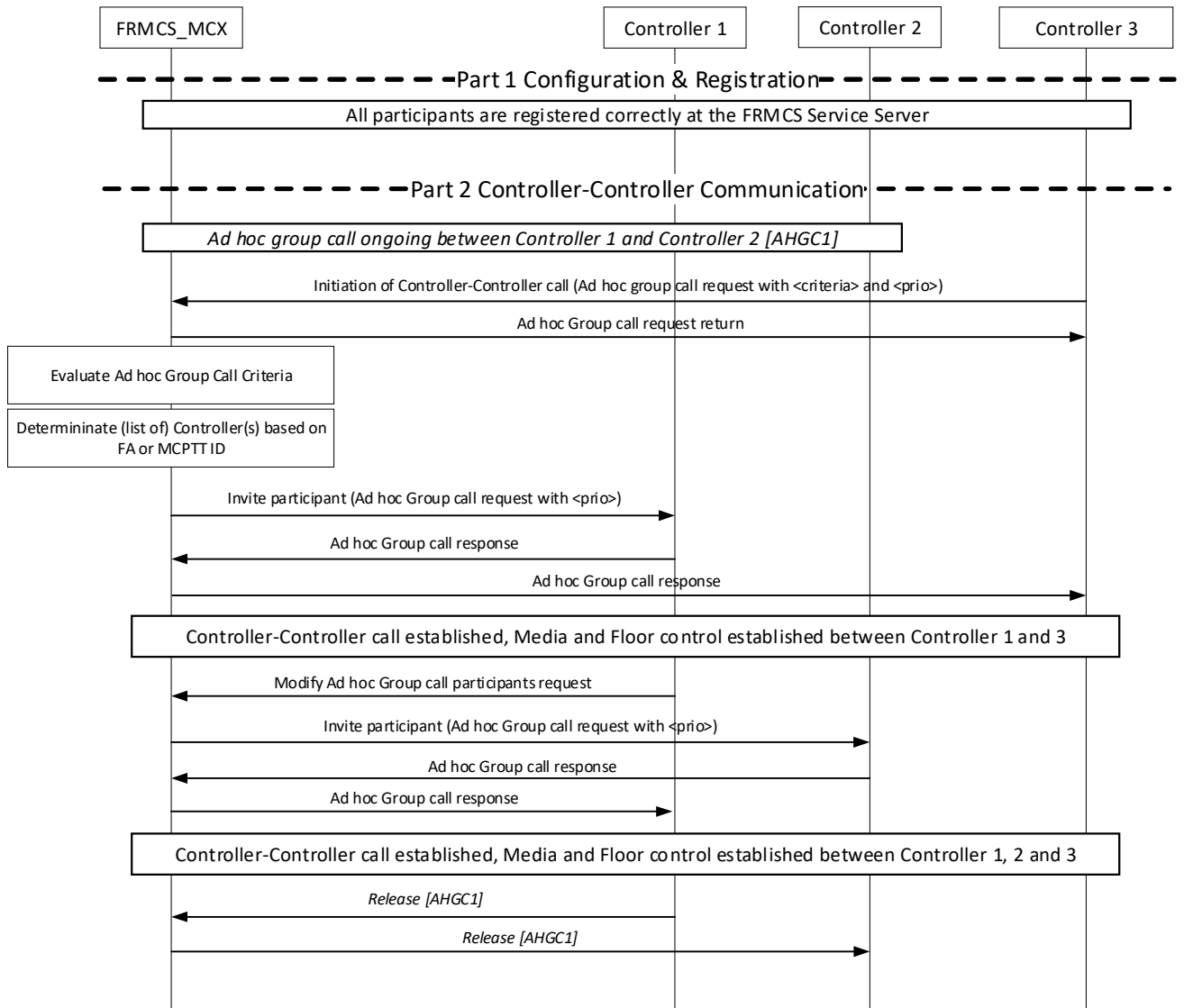

Figure 42: Pseudo-merging of two ongoing voice communications flow

#### Flow Description:

4.4.5.9.2. The call related operations depicted in Figure 42 to perform the pseudo-merging of two voice communications between controllers using ad-hoc group call shall be achieved if, as prerequisite, the following conditions are fulfilled: (M-V3)

- a) All clients participating in communication are registered correctly at the FRMCS Service Server
- b) Controller is registered as controller identity
- c) Roles (Functional Alias) have been registered accordingly by all participants
- d) An Ad hoc group call is established and on-going between Controller 1 and Controller 2 (AHGC1)
- e) A controller or driver is currently initiating an Ad hoc group call with specific criteria parameters included as defined in sections 4.4.5.1, 4.4.5.2 or 4.4.5.5.

- 4.4.5.9.3. To achieve the call related operations as depicted in Figure 42, Controller1 shall be able to place itself on-hold (queuing) in the former Ad hoc group call (AHGC1) and then to join the newly established Ad hoc group call. (M-V3)
- 4.4.5.9.4. As an intermediate outcome of the call related operation depicted in Figure 42, the two ad hoc group call shall be established and kept ongoing between all determined participants with Controller1 participating in AHGC2 while AHGC1 is his communication queue (hold). (M-V3)
- 4.4.5.9.5. To achieve the call related operations as depicted in Figure 38, Controller1 shall be able to modify the Ad hoc group call to include in the newly established Ad hoc group call all participants of AHGC1 and then to request the release of AHGC1. (M-V3)
- 4.4.5.9.6. As the outcome of the call related operations depicted in Figure 42, the newly established Ad hoc group call shall be kept ongoing and shall include the participants initially involved in each of the two Ad hoc group call. (M-V3)

#### 4.4.5.10. Floor request for voice communication

- 4.4.5.10.1. The message flow for requesting floor by a specific User shall be based on the defined mechanism for floor control for ad hoc group calls as defined in [TS 23.379]. (M)
- 4.4.5.10.2. The voice floor control mechanism shall determine the floor priority as per effective floor priority determination defined in [TS 24.380] Chapter 4.1.1.4. (M)
- 4.4.5.10.3. The floor priority for dispatcher Users shall be always higher than for other voice participants, using a defined higher floor priority number in the Floor Request message. (M)
- 4.4.5.10.4. The floor priority for dispatcher Users shall be pre-emptive such as the current talker is overridden. (M)

[Editor's Note26] *In this version of the document single user talker control is defined (only a single user is allowed to talk).*

- 4.4.5.10.5. The floor priority for non-dispatcher Users shall use a floor-priority defined by configuration, lower than dispatcher User floor-priority. (M)
- 4.4.5.10.6. The floor priority scheme defined in [FRMCS SRS] shall be used by the participants. (M-V3)

[Editor's Note27] *The expected floor priority scheme for Voice communication applications should be reflected in FRS in the next version.*

#### 4.4.6. Voice communication criteria definition

- 4.4.6.1.1. The following list of criteria shall be supported for voice communication call control as parameter in 3GPP ad hoc group call flows as “Criteria for determining the participants”. (M)
- 4.4.6.1.2. The criteria shall be insert inserted as a <call-participants-criterias> with one or more criteria as a comma separated list into <anyExt> element of <mcptt-Params> element of <mcpttinfo> element of the application/vnd.3gpp.mcptt-info+xml MIME body in the SIP INVITE request, as per [TS 24.379]. (M)
- 4.4.6.1.3. The comma separated list shall be of the following format: criteria\_name\_1=“Value\_1”, criteria\_name\_2=“Value\_2”,..., criteria\_name\_n=“Value\_n”. For example FRMCS\_CallType=“FRMCS\_CT\_CONTROLLER2CONTROLLER”, FRMCS\_UseInitiatorLocation=“True” . (M)
- 4.4.6.1.4. All criteria as shown in the following list are used by the initiator in the initiation message, and by the FRMCS server for the evaluation of the initiation message. (I)

Criteria name	Criteria parameter	Usage by initiator <sup>1)</sup>					Description	Category
		§ 4.4.5.1	§ 4.4.5.2	§ 4.4.5.3	§ 4.4.5.4	§ 4.4.5.5		
FRMCS_CallType		R	R	R	R	R	Definition of Adhoc Call Type	M
FRMCS_UseInitiator Location (Boolean)	-	R		R			Service Server shall take location of initiator into account for addressing area determination	M
FRMCS_UseAddressedArea (Boolean)	-	R	R	R	R	R	Service Server shall take addressed area into account instead of server based addressing area definition Usage of this parameter requires to have either the FRMCS_ListOfAddressedArea or the FRMCS_AddressedAreaPolygon criteria to be present.	M
FRMCS_ListOfAddressedArea (List of Areas)	Area_1; Area_2; ... Area_n				R <sup>2)</sup>		List of Addressed Areas the server shall take into account for evaluation. The server shall take the union of all Addressed Areas into account  Area_x can shall be an area name (equal to Location Label)	M for single area M-Vx for multiple area Area
FRMCS_AddressedAreaPolygon	AreaPolygon;						Addressed area the server takes into account for evaluation.  Area_x is a polygon definition	M-Vx



Criteria name	Criteria parameter	Usage by initiator <sup>1)</sup>					Description	Category
		§ 4.1	§ 4.2	§ 4.3	§ 4.4	§ 4.5		
							In case of polygon definition, the addressed controllers shall be all the controllers associated to the predefined Addressed Areas fully or partially included in the manually defined area.	
FRMCS_TargetParticipantFA (List of FAs)	FA1; FA2; .... FA_n		R <sup>2)</sup>			R <sup>2)</sup>	List of target Functional Aliases the communication is addressed to.	M-V3
FRMCS_TargetParticipantUserID (List of MC User IDs)	ID1; ID2; .... ID_n		R <sup>2)</sup>			R <sup>2)</sup>	List of target MC Service User IDs the communication is addressed to.	M-V3

Table 4: List of criteria for ad hoc group used for voice communications

Legend:

R	Criteria is always required
---	-----------------------------

Note 1): The columns indicate the applicability for message flows according to the sub-chapters of this document.

Note 2): Either FRMCS\_TargetParticipantFA or FRMCS\_TargetParticipantUserID will be used.

#### 4.4.7. FRMCS call queueing on voice communication application level

[Editor's Note28] *A change request is ongoing at 3GPP level in order to achieve the call queueing mechanism needed for FRMCS but specification could only be available in Rel19 or even Rel20.*

## 4.5. Train control and monitoring system

### 4.5.1. Introduction

- 4.5.1.1.1. This section specifies basic communication requirements for the TCMS system. (I)
- 4.5.1.1.2. TCMS establish communication from the vehicle to the trackside. After the communication is established, commands and data transfer can be initiated from any direction. (I)
- 4.5.1.1.3. Features of TCMS requiring communication are for example:(I)
  - a) Installation of software and security packages.
  - b) Alarm and event handling.
  - c) Telemetry.
  - d) Transfer of system logs.
  - e) Configuration of operational parameters.
  - f) Passenger information application.

### 4.5.2. TCMS Train to Track Communication

- 4.5.2.1.1. LC access mode as specified in section 2.1 shall be used for communication between the TCMS onboard application and the TCMS trackside application. (M)
- 4.5.2.1.2. The access mode to use (LC H2H, LC H2N or SLC) is left open for implementation. (I)
- 4.5.2.1.3. The Session Start shall be initiated by onboard TCMS application. (M)
- 4.5.2.1.4. The destination address(es) to the TCMS trackside application shall be configured in the TCMS onboard application or in the third-party entity placed between the TCMS onboard application and the On-Board FRMCS, in URI/SIP format. (M)

## 5. Coordinating function for voice applications

Intentionally deleted.

## 6. FRMCS/GSM-R interworking

Intentionally deleted.

## 7. Annex A: REC Implementation Options

Intentionally deleted.

## 8. Annex B: Interoperability requirements in EU

This annex is the placeholder for identifying the requirements relevant for interoperability in the European Union, i.e. the requirements, with respect to the authorisation in the EU according to the TSI, that are considered in the European Directives to be relevant for interoperability as fulfilling the essential requirements for the Control-Command and Signalling (CCS) subsystem related to safety and technical compatibility which must be met by the rail system, the subsystems, and the interoperability constituents, including interfaces according to the corresponding conditions set out in Directive (EU) 2016/797. It is mandatory that each railway subsystem in the EU meets these requirements on lines under the scope of the Directive and the CCS TSI to ensure technical compatibility between Member States and safe integration between train and track.

At this stage, the version of this specification is not considered complete for the purpose of tendering On-Board FRMCS equipment, and the identification of all requirements relevant for interoperability is for further study.

This annex part is therefore only informative.

### 8.1. Scope and Purpose

- 8.1.1 This document lists a classification into categories of all the clauses in the Form Fit Functional Interface Specification (FRMCS FIS).
- 8.1.2 The purpose of this document is to ease the assessment of the compliance of a FRMCS on-board and trackside equipment with the FIS.
- 8.1.3 To that effect, this document comprehensively identifies which clauses contain requirements allocated to the FRMCS on-board and/or trackside equipment and conversely which ones do not.

### 8.2. Definitions

- 8.2.1 The following categories are used to classify each FIS clause:
  - 8.2.1.1 Candidate MI requirement: a requirement that, as expressed in this FRMCS V2 specification, is considered to be related to interoperability (MI=mandatory for interoperability in Europe). This pre-assessment can be used to focus on the requirements that shall be completed in FRMCS V3 and also, to drive attention to the fact that a latter inclusion of the identified functionality will have to be done with careful attention to the compatibility between new and previous installations.
  - 8.2.1.2 Note that the identification of “candidate MI” requirements is just an indication to the reader, and, since this FRMCS V2 version is not to be part of a CCS TSI and the specifications are not yet ready for product production, it has no impact on the certification tasks of the Notified Bodies.
- 8.2.2 In case a requirement equally applies to both FRMCS on-board equipment and FRMCS trackside or in case it is not possible to distinguish between on-board and trackside functionality, requirements are kept together in the concerned clause.

### 8.3. List of MI Candidate clauses

The table below covers sections and individual requirements of the FIS.

Section	Requirements	Candidate MI for TS (MI/O)	Candidate MI for OB (MI/O)	Notes
2.1 Service Session for LC	Those proposed as M:	MI	MI	
	2.1.2.1.2			
	2.1.2.1.6			
	2.1.2.1.6i			
	2.1.2.1.8			
	2.1.2.1.8i			
	2.1.2.1.9			
	2.1.2.1.9i			
	2.1.2.1.10			
	2.1.2.1.12			
	2.1.2.1.13			
	2.1.3.1.3			
	2.1.3.1.4			
	2.1.3.1.5			
	2.1.3.1.7			
	2.1.3.1.8			
	2.1.3.1.9			
	2.1.3.1.10			
	2.1.3.1.11			
	2.1.3.1.11i			
	2.1.3.1.11iii			
	2.1.3.1.12			
	2.1.3.1.14			
2.1.3.1.15				
2.1.3.1.16				
2.1.3.1.17				
2.1.4.1.2				
2.1.4.1.3				
2.1.4.1.4				
2.2 Service Session for TC mode	Those proposed as M:	MI	MI	
	2.2.2.1.1			
	2.2.2.1.3			

Section	Requirements	Candidate MI for TS (MI/O)	Candidate MI for OB (MI/O)	Notes
	2.2.2.1.4 2.2.2.1.6 2.2.2.1.7 2.2.2.1.8 2.2.2.1.9 2.2.2.1.10 2.2.2.1.11			
3.1 Role management	Those proposed as M and M-V3: 3.1.2.1.2 3.1.2.1.9 3.1.2.1.10 3.1.2.1.11 3.1.2.1.12 3.1.2.1.13 3.1.3.1.1 3.1.3.2.1 3.1.3.2.2 3.1.3.2.3 3.1.3.3.1 3.1.3.3.2 3.1.3.3.3 3.1.3.4.1 3.1.3.4.2 3.1.3.4.3 3.1.3.6.1 3.1.3.6.2 3.1.3.7.1 3.1.3.7.2	MI	MI	
3.2 Location services common function	Those proposed as M: 3.2.2.1.1 3.2.2.1.4iii 3.2.2.1.4iv 3.2.2.1.5	MI	MI	



Section	Requirements	Candidate MI for TS (MI/O)	Candidate MI for OB (MI/O)	Notes
	3.2.2.1.7 3.2.2.1.8 3.2.2.1.8i 3.2.2.1.11			
3.3 Arbitration common function	Those proposed as M and M-V3: 3.3.2.1.1 3.3.2.1.2 3.3.2.1.3 3.3.2.1.4 3.3.2.1.5 3.3.2.1.6 3.3.2.1.7 3.3.2.1.9 3.3.2.1.10 3.3.2.1.11 3.3.2.1.13 3.3.2.1.14	MI	MI	
3.4 Inter-FRMCS-Service-Domain Transition	Those proposed as M: 3.4.3.1.1 3.4.3.1.4	MI	MI	
4.1 Automatic train protection	Those proposed as M and M-V3: 4.1.2.1.1 4.1.2.1.2 4.1.2.1.5 4.1.4.1.2 4.1.5.2.1 4.1.5.2.2 4.1.5.3.1 4.1.6.2.2 4.1.6.2.3 4.1.6.3.6 4.1.6.3.8 4.1.7.2.1	MI	MI	

Section	Requirements	Candidate MI for TS (MI/O)	Candidate MI for OB (MI/O)	Notes
	4.1.7.3.1 4.1.7.4.1			
4.2 Automatic train operation	Those proposed as M: 4.2.2.1.1 4.2.2.1.2 4.2.2.1.5 4.2.4.1.2 4.2.5.1.1 4.2.5.1.2 4.2.6.1.1 4.2.7.1.1	MI	MI	
4.3 Railway emergency communication	Those proposed as M and M-V3: 4.3.1.1.2 4.3.2.1.1 4.3.2.1.2 4.3.2.1.2i 4.3.3.1.3 4.3.3.1.4 4.3.4.1.2 4.3.4.1.3 4.3.4.1.4 4.3.4.1.8 4.3.4.1.9 4.3.5.1.1ii 4.3.5.1.2 4.3.6.1.3 4.3.6.1.5 4.3.6.2.1 4.3.6.2.1i 4.3.6.2.1ii 4.3.6.2.1iii 4.3.6.2.1iv 4.3.6.2.1v	MI	MI	

Section	Requirements	Candidate MI for TS (MI/O)	Candidate MI for OB (MI/O)	Notes
	4.3.6.2.2			
	4.3.6.2.3			
	4.3.6.3.1			
	4.3.6.3.1i			
	4.3.6.3.3			
	4.3.6.3.4			
	4.3.6.3.5			
	4.3.6.3.6			
	4.3.6.3.7			
	4.3.6.3.8			
	4.3.6.4.1			
	4.3.6.4.1i			
	4.3.6.4.3			
	4.3.6.4.4			
	4.3.6.4.5			
	4.3.6.4.6			
	4.3.6.4.7			
	4.3.6.4.8			
	4.3.6.5.1			
	4.3.6.5.2			
	4.3.6.5.2i			
	4.3.6.5.2ii			
	4.3.6.5.2iii			
	4.3.6.5.2iv			
	4.3.6.5.3			
	4.3.6.5.4			
	4.3.6.6.1			
	4.3.6.6.3			
	4.3.6.6.4			
	4.3.6.6.5			
	4.3.6.6.6			
	4.3.6.6.7			
	4.3.6.6.8			
	4.3.6.6.9			

Section	Requirements	Candidate MI for TS (MI/O)	Candidate MI for OB (MI/O)	Notes
	4.3.6.7.1 4.3.6.7.2 4.3.6.7.3 4.3.6.7.4 4.3.6.7.5 4.3.6.7.6 4.3.6.7.7 4.3.6.7.8 4.3.6.8.1 4.3.6.9.1 4.3.6.9.3 4.3.6.10.1 4.3.6.10.2 4.3.6.10.3 4.3.6.10.4 4.3.6.10.5 4.3.6.11.1 4.3.7.1.1 4.3.7.1.2 4.3.8.1.1 4.3.8.1.2 4.3.8.1.3 4.3.8.1.4 4.3.8.1.5 4.3.8.1.6			
4.4 Voice communications	Those proposed as M and M-V3: 4.4.2.1.1 4.4.2.1.2 4.4.2.1.3 4.4.3.1.3 4.4.3.1.4 4.4.3.1.5 4.4.3.1.6	MI	MI	

Section	Requirements	Candidate MI for TS (MI/O)	Candidate MI for OB (MI/O)	Notes
	4.4.4.1.1i			
	4.4.4.1.2			
	4.4.5.1.1			
	4.4.5.1.2			
	4.4.5.1.3			
	4.4.5.1.4			
	4.4.5.1.5			
	4.4.5.1.6			
	4.4.5.1.7			
	4.4.5.2.1			
	4.4.5.2.2			
	4.4.5.2.3			
	4.4.5.2.4			
	4.4.5.2.5			
	4.4.5.2.6			
	4.4.5.2.7			
	4.4.5.3.1			
	4.4.5.3.2			
	4.4.5.3.3			
	4.4.5.3.4			
	4.4.5.3.5			
	4.4.5.3.6			
	4.4.5.3.7			
	4.4.5.4.1			
	4.4.5.4.2			
	4.4.5.4.3			
	4.4.5.4.4			
	4.4.5.4.5			
	4.4.5.4.6			
	4.4.5.4.7			
	4.4.5.5.1			
	4.4.5.5.2			
	4.4.5.5.3			
	4.4.5.5.4			

Section	Requirements	Candidate MI for TS (MI/O)	Candidate MI for OB (MI/O)	Notes
	4.4.5.5.5			
	4.4.5.5.6			
	4.4.5.8.1			
	4.4.5.8.2			
	4.4.5.8.3			
	4.4.5.8.4			
	4.4.5.8.5			
	4.4.5.8.6			
	4.4.5.9.1			
	4.4.5.9.2			
	4.4.5.9.3			
	4.4.5.9.4			
	4.4.5.9.5			
	4.4.5.9.6			
	4.4.5.10.1			
	4.4.5.10.2			
	4.4.5.10.3			
	4.4.5.10.4			
	4.4.5.10.5			
	4.4.5.10.6			
	4.4.6.1.1			
	4.4.6.1.2			
	4.4.6.1.3			
	4.4.6.1.4			



Printed by

International Union of Railways

16, rue Jean Rey 75015 Paris – France

April 2025

Legal deposit: April 2025

ISBN 978-2-7461-3127-9