



ERTMS/ETCS

ETCS System Version Management

REF : SUBSET-104

ISSUE : 3.2.0

DATE : 12/05/14

1. MODIFICATION HISTORY

Issue Number Date	Section Number	Modification / Description	Author
Issue 0.0.1 2004-10-04		First Issue	Hougardy A.
Issue 0.0.2 2004-12-06		See revision marks	Hougardy A.
Issue 0.0.3 2005-12-06		Update of table 4.3.1 according to TSI annex A 12/12/05 Update of annex C, according to SRS 2.3.0	Hougardy A.
Issue 0.0.4 2006-09-13		According to review held in SVM WG meetings # 4, 5, 6	Hougardy A.
Issue 0.0.5 2006-11-24		According to review held in SVM WG meeting # 7 & 8	Hougardy A.
Issue 0.0.6 2006-12-26		According to review held in SVM WG meeting # 9	Hougardy A.
Issue 0.0.7 2007-02-14		According to review held in SVM WG meeting # 10	Hougardy A.
Issue 0.0.8 2008-11-28		Feedback from implementation of CR 757 into the SRS, according to ad-hoc meeting 19/11/08.	Hougardy A.
Issue 3.0.0 2008-12-23		Release version	Hougardy A.
Issue 3.0.1 2012-02-23		Update according to TSI annex A list amended for Baseline 3	Hougardy A.
Issue 3.1.0 2012-02-29		Minor editorial corrections Baseline 3 release version	Hougardy A.
Issue 3.1.1 2014-04-23	4.3.2	Update according to TSI annex A list amended for Baseline 3 1st maintenance release Baseline 3 1st maintenance pre-release version	Hougardy A.

<p>Issue 3.1.2 2014-05-07</p>	<p>4.3.2</p>	<p>Old misalignment with TSI annex A list Baseline 3 1st maintenance 2nd pre-release version</p>	<p>Hougardy A.</p>
<p>Issue 3.2.0 2014-05-12</p>		<p>Baseline 3 1st maintenance release version</p>	<p>Hougardy A.</p>

2. TABLE OF CONTENTS

1. MODIFICATION HISTORY	2
2. TABLE OF CONTENTS.....	4
3. INTRODUCTION.....	6
3.1 Scope and purpose.....	6
3.2 Content	6
3.3 References	6
3.4 Terms, definitions and abbreviations.....	6
4. SYSTEM VERSION DEFINITION	8
4.1 What system version is	8
4.2 What system version is not	8
4.3 What can affect system version.....	8
4.3.1 Foreword.....	8
4.3.2 TSI annex A documents impacting system version	8
4.4 Identification/evolution of the versions.....	11
4.5 Operated system version versus system version in ERTMS/ETCS constituents	12
4.5.1 Operated system version	12
4.5.2 System version in ERTMS/ETCS constituents	12
5. COMPATIBILITY/INCOMPATIBILITY CRITERIA	13
5.1 Definitions	13
5.2 Evaluation of a new baseline.....	14
5.3 Evaluation of a single CR.....	15
5.3.1 Decision chart.....	15
5.3.2 Explanatory table for compatibility/incompatibility decision chart.....	16
6. COEXISTENCE OF SYSTEM VERSIONS.....	17
6.1 System principles.....	17
6.1.1 Introduction	17
6.1.2 Legally operated system versions	18
6.1.3 Uniqueness of the reference baseline	19
6.2 Coexistence of incompatible system versions: trackside infrastructures.....	19
6.2.1 Principles	19
6.2.2 Example.....	20
6.2.3 Level 0/STM areas.....	29
6.3 Coexistence of compatible system versions: trackside infrastructures.....	29
6.4 Coexistence of compatible/incompatible system versions: on-board equipments.....	30
7. MIGRATION STRATEGY	31
7.1 Introduction	31
7.2 Migration models.....	31

7.2.1	Model 1: new X version with no phasing out of older X version	31
7.2.2	Model 2: new X version with phasing out of oldest X version	33
7.2.3	Model 3: Phasing out of oldest X version with no new X version	35
8.	ANNEXES	37
8.1	Annex A: Guidelines for assessment of the size of the envelope of legally operated X versions	37
8.1.1	Introduction	37
8.1.2	Context	37
8.1.3	Technical criteria	37
8.1.4	Economic criteria	38
8.1.5	Operational criteria	38
8.1.6	Direction or Regulation criteria	38
8.2	Annex B: Migration parameters	39
8.2.1	Introduction	39
8.2.2	Model 1: new X version with no phasing out of older X version	39
8.2.3	Model 2: new X version with phasing out of oldest X version	39
8.2.4	Model 3: phasing out of oldest X version with no new X version	40

3. INTRODUCTION

3.1 Scope and purpose

- 3.1.1.1 This document aims at defining unambiguously what is the ERTMS/ETCS system version and hence at clarifying what does affect and what does not affect the ERTMS/ETCS system version.
- 3.1.1.2 This document deals with ERTMS/ETCS system version management related to interoperability between ERTMS/ETCS trackside and on-board equipments.
- 3.1.1.3 In particular, system version management with regard to STMs is not considered in this document.
- 3.1.1.4 This document describes how and when to upgrade the ERTMS/ETCS system version on the trackside and on-board assemblies, during the ERTMS/ETCS system lifetime.
- 3.1.1.5 Even though this document gives some directions, how and when to reach the decision to create a new ERTMS/ETCS system version is outside the scope of this document, as this decision can only be taken in the frame of the ERA Change Control Management.
- 3.1.1.6 Additional requirements regarding management of ERTMS/ETCS system version by ERTMS/ETCS trackside and on-board equipments are described in Subset 026.

3.2 Content

- 3.2.1.1 This document covers the following subjects:
 1. Definition of the ERTMS/ETCS system version.
 2. Definition of the criteria leading to compatibility or incompatibility between two consecutive ERTMS/ETCS system versions.
 3. Coexistence of non-homogeneous ERTMS/ETCS trackside installations and on-board equipments throughout Europe.
 4. Description of migration strategy for upgrading ERTMS/ETCS trackside and on-board equipments towards new ERTMS/ETCS system versions.

3.3 References

ERA_ERTMS_000 1	ERTMS Change Control Management process, version 2.0
Subset 023	ERTMS/ETCS Glossary of Terms and Abbreviations
Subset 026	ERTMS/ETCS System Requirements Specification

3.4 Terms, definitions and abbreviations

- 3.4.1.1 For general terms, definitions and abbreviations refer to [Subset 023]
- 3.4.1.2 Other abbreviations used in this document are listed in the table below

Abbreviation	Definition
CCM	Change Control Management
CR	Change Request
IM	Infrastructure Manager
LOP	Legally Operable
PO	Phasing Out
RU	Railway Undertaking

4. SYSTEM VERSION DEFINITION

4.1 What system version is

4.1.1.1 The system version defines unambiguously the ETCS mandatory functions that ensure technical interoperability between ERTMS/ETCS on-board and trackside subsystems.

4.2 What system version is not

4.2.1.1 The ERTMS/ETCS system version is neither to be assimilated to an ERTMS/ETCS baseline nor to a baseline release of the TSI Annex A

4.2.1.2 The ERTMS/ETCS system version is not defined by a single document such as the SRS, even if the version number of this latter has been often used to identify the system version.

4.2.1.2.1 Note: as a matter a fact, the version number of the SRS is incremented each time there is a new system version, at least because definition of variable M_VERSION (in SRS chapter 7) has to be changed.

4.2.1.3 The ERTMS/ETCS system version is not the version of the ETCS language (the so-called airgap) or any other standardised language within the ERTMS/ETCS specifications.

4.2.1.4 The ERTMS/ETCS system version is not to be confused with any supplier's product version, which may be upgraded for other reasons.

4.3 What can affect system version

4.3.1 Foreword

4.3.1.1 The system version is used to prevent situations leading to an unacceptable reduction of safety or performance, due to changes in the ERTMS/ETCS specifications.

4.3.1.2 Therefore, any technical change having the potential to change the behaviour, the performance or the safety of the ERTMS/ETCS system shall be considered as impacting the system version.

4.3.2 TSI annex A documents impacting system version

4.3.2.1 The table below identifies amongst the complete list of TSI Annex A mandatory specifications, the ones potentially impacting directly the ERTMS/ETCS system version.

4.3.2.2 Note: the purpose of this table is to provide a decision tool to the ERA CCM Control Group, when packaging CRs intended for a future baseline.

Index N	Reference	Document Name	Impacting
1	Intentionally Deleted		

Index N	Reference	Document Name	Impacting
2	Intentionally Deleted		
3	SUBSET-023	Glossary of Terms and Abbreviations	N
4	SUBSET-026	System Requirements Specification	Y
5	SUBSET-027	FIS Juridical Recording	N
6	ERA_ERTMS_015560	ETCS Driver Machine Interface	N
7	SUBSET-034	Train Interface FIS	N
8	SUBSET-035	Specific Transmission Module FFFIS	Y
9	SUBSET-036	FFFIS for Eurobalise	Y
10	SUBSET-037	Euroradio FIS	Y
11	SUBSET-038	Off-line Key Management FIS	N
12	SUBSET-039	FIS for the RBC/RBC Handover	N
13	SUBSET-040	Dimensioning and Engineering rules	Y
14	SUBSET-041	Performance Requirements for Interoperability	Y
15	Intentionally Deleted		
16	SUBSET-044	FFFIS for Euroloop subsystem	Y
17	Intentionally Deleted		
18	Intentionally Deleted		
19	SUBSET-047	Track-side-Trainborne FIS for Radio In-Fill	Y
20	SUBSET-048	Trainborne FFFIS for Radio In-Fill	Y
21	Intentionally Deleted		
22	Intentionally Deleted		
23	SUBSET-054	Responsibilities and rules for the assignment of values to ETCS variables	N
24	Intentionally Deleted		
25	SUBSET-056	STM FFFIS Safe Time Layer	N
26	SUBSET-057	STM FFFIS Safe Link Layer	N
27	SUBSET-091	Safety Requirements for the Technical Interoperability of ETCS in Levels 1 & 2	Y
28	Intentionally Deleted		
29	SUBSET-102	Test specification for Interface "K"	N
30	Intentionally deleted		
31	SUBSET-094	Functional Requirements for an On-board Reference Test Facility	N
32	EIRENE FRS	GSM-R Functional Requirements Specification	Y

Index N	Reference	Document Name	Impacting
33	EIRENE SRS	GSM-R System Requirements Specification	Y
34	A11T6001	(MORANE) Radio Transmission FFFIS for EuroRadio	Y
35	Intentionally deleted		
36a	Intentionally deleted		
36b	Intentionally deleted		
36c	SUBSET-074-2	FFFIS STM Test cases document	N
37a	Intentionally deleted		
37b	SUBSET-076-5-2	Test cases related to features	N
37c	Reserved SUBSET-076-6-3	Test sequences	N
37d	SUBSET-076-7	Scope of the test specifications	N
37e	Intentionally deleted		
38	06E068	ETCS Marker board definition	N
39	SUBSET-092-1	ERTMS EuroRadio Conformance Requirements	N
40	SUBSET-092-2	ERTMS EuroRadio Test cases Safety Layer	N
41	Intentionally deleted		
42	Intentionally deleted		
43	SUBSET-085	Test Specification for Eurobalise FFFIS	N
44	Intentionally Deleted		
45	SUBSET-101	Interface "K" Specification	N
46	SUBSET-100	Interface "G" specification	N
47	Intentionally deleted		
48	Intentionally Deleted		
49	SUBSET-059	Performance requirements for STM	N
50	SUBSET-103	Test specification for EUROLOOP	N
51	Intentionally deleted		
52	SUBSET-058	FFFIS STM Application Layer	N
53	Intentionally deleted		
54	Intentionally deleted		
55	Intentionally deleted		
56	Intentionally deleted		
57	Intentionally deleted		
58	Intentionally deleted		
59	Intentionally deleted		

Index N	Reference	Document Name	Impacting
60	SUBSET-104	ETCS System Version Management	N
61	Intentionally deleted		
62	Intentionally deleted		
63	SUBSET-098	RBC-RBC Safe Communication Interface	N
64	EN 301 515	Global System for Mobile Communication (GSM); Requirements for GSM operation on railways	N
65	TR 102 281	Detailed requirements for GSM operation on railways	N
66	TS 103 169	ASCI Options for Interoperability	N
67	(MORANE) P 38 T 9001	FFFIS for GSM-R SIM Cards	N
68	ETSI TS 102 610	Railway Telecommunication; GSM; Usage of the UUIE for GSM operation on railways	N
69	(MORANE) F 10 T 6002	FFFS for Confirmation of High Priority Calls'	N
70	(MORANE) F 12 T 6002	FIS for Confirmation of High Priority Calls	N
71	(MORANE) E 10 T 6001	FFFS for Functional Addressing	N
72	(MORANE) E 12 T 6001	FIS for Functional Addressing	N
73	(MORANE) F 10 T6001	FFFS for Location Dependent Addressing	N
74	(MORANE) F 12 T6001	FIS for Location Dependent Addressing	N
75	(MORANE) F 10 T 6003	FFFS for Presentation of Functional Numbers to Called and Calling Parties	N
76	(MORANE) F 12 T 6003	FIS for Presentation of Functional Numbers to Called and Calling Parties	N
77	ERA/ERTMS/033281	Interfaces between CCS track-side and other subsystems	N
78	Intentionally Deleted		
79	SUBSET-114	KMC-ETCS Entity Off-line KM FIS	N
80	Intentionally Deleted		

4.4 Identification/evolution of the versions

- 4.4.1.1 The evolution of the versions of the ERTMS/ETCS system shall be sequential, i.e. there shall only be one direct upgrade of an existing version and no branch is accepted.
- 4.4.1.2 The version of the ERTMS/ETCS system shall be identified by a version number which complies with the following:

- Each version number will have the following format: X.Y, where X is any number between 1 and 7 and Y is any between 0 and 15. Examples: 2.0, 3.7, 5.15
 - The first number distinguishes incompatible versions.
 - The second number indicates compatibility within a version X.
 - If the first numbers of two versions are the same, this indicates that those versions are compatible, independently of the second number. (e.g. version 3.5 is compatible with 3.3, 3.0, 3.6,...).
- 4.4.1.3 The way to transmit the balise, Euroloop, Radio Infill Unit and RBC version shall not be subject to evolution.

4.5 Operated system version versus system version in ERTMS/ETCS constituents

4.5.1 Operated system version

- 4.5.1.1 From a general point of view, to operate a system version means to comply with all requirements from all TSI annex A documents impacting the system version (see 4.3.2).
- 4.5.1.2 The operated system version is determined by trackside; in that respect, to operate a system version number X within a delimited trackside area means that all on-board equipments running on this area shall behave according to the set of requirements applicable to this operated version (see section 6.1.3 for further details).
- 4.5.1.3 By definition, on-board equipment may support a system version number Y different from the one ordered by trackside. This underlines the fact that only system version number X is relevant, for the determination of the version to be operated.

4.5.2 System version in ERTMS/ETCS constituents

- 4.5.2.1 The system version(s) of an ERTMS/ETCS constituent must be regarded separately from the operated system version:
- a) The system versions supported by on-board equipment indicate the different trackside areas, operated with any of these system versions, on which on-board is able to operate;
 - b) The system version transmitted by RBC indicates the system version operated in the RBC area; it also implies that the version of ETCS language specified for the operated system version is used to dialog with on-board equipments;
 - c) The system version transmitted by RIU indicates that the version of ETCS language specified for the corresponding system version is used to encode the transmitted information;
 - d) The system version marked in the header of telegram/message transmitted by balises/loops indicates that the version of ETCS language specified for the corresponding system version is used to encode the transmitted information.

5. COMPATIBILITY/INCOMPATIBILITY CRITERIA

5.1 Definitions

- 5.1.1.1 The compatibility/incompatibility between two consecutive ERTMS/ETCS system versions is established by analysing the relationship between an ERTMS/ETCS on-board equipment operating one system version and an ERTMS/ETCS trackside infrastructure operated with the other one.
- 5.1.1.2 In the following sections, version A is the existing system version, while version B is the subsequent system version, for which the compatibility/incompatibility is to be determined.
- 5.1.1.3 The version B is compatible with version A if both following conditions are met (see Figure 1):
- a) a train operating version A can run a normal service on trackside infrastructure operated with version B
 - b) a train operating version B can run a normal service on trackside infrastructure operated with version A
- 5.1.1.4 Conversely, the version B is incompatible with version A if one of following conditions is met (see Figure 2):
- a) there is a technical, operational or safety related obstacle preventing a train operating version A from running a normal service on a trackside infrastructure operated with version B
 - b) there is a technical, operational or safety related obstacle preventing a train operating version B from running a normal service on a trackside infrastructure operated with version A
- 5.1.1.5 The expression “train running a normal service” shall be understood as “train which is not penalised because of a reduction of performance or safety”.

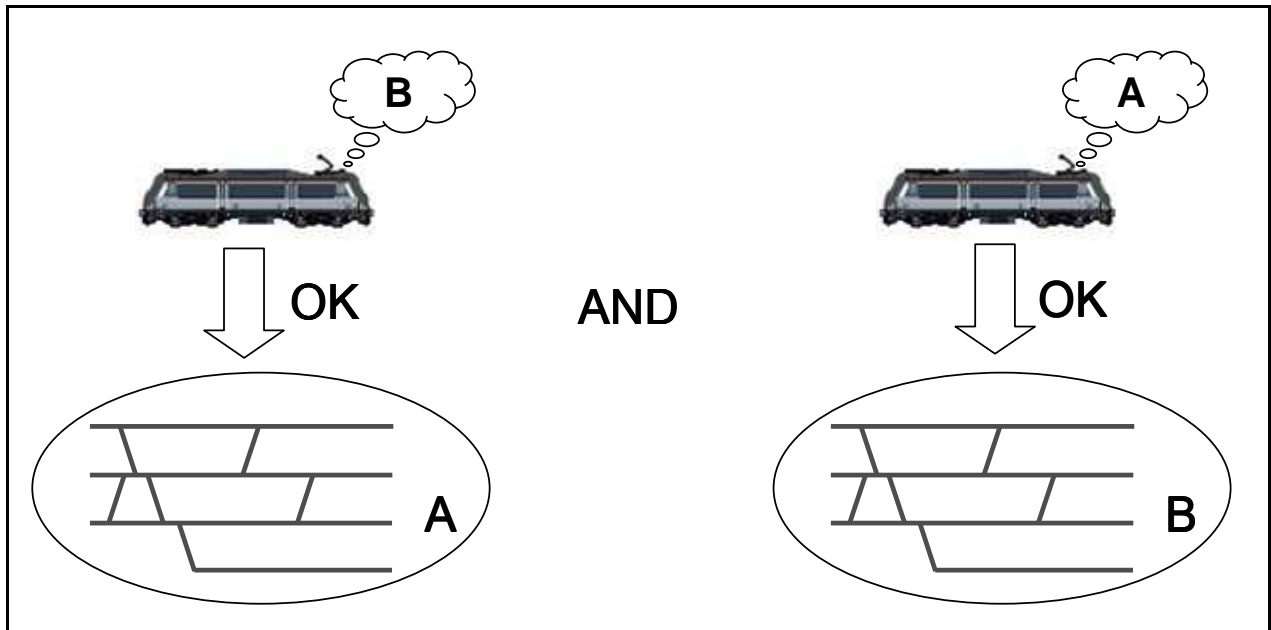

Figure 1: compatibility of system versions A & B

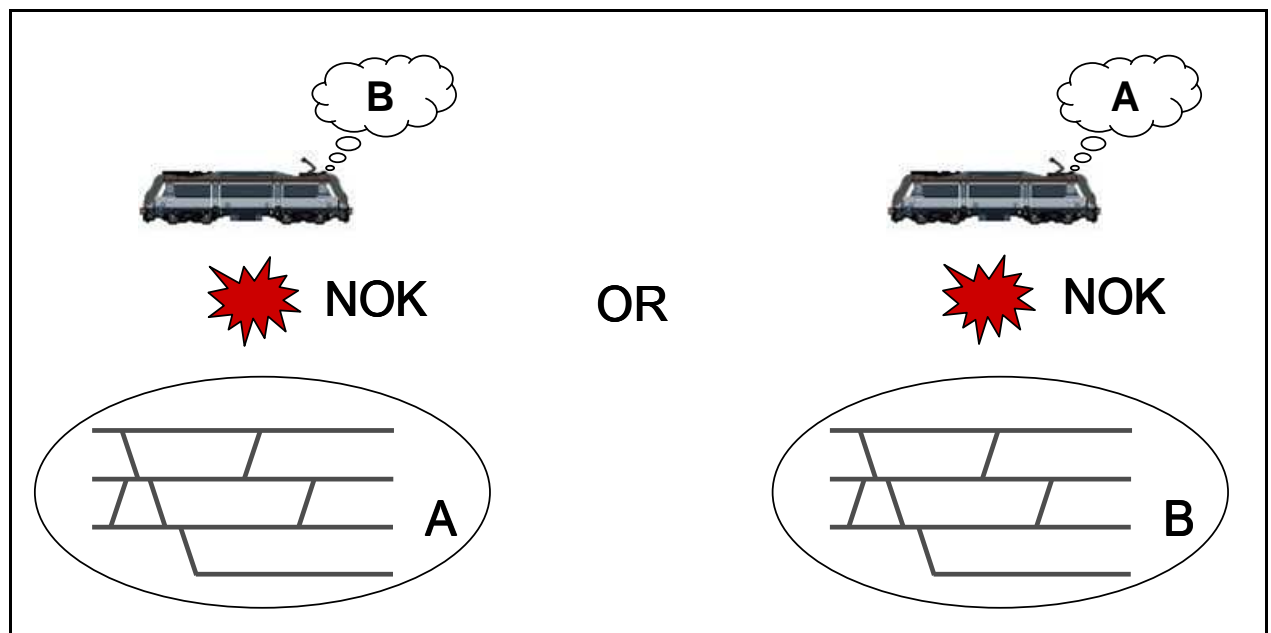

Figure 2: incompatibility of system versions A & B

5.2 Evaluation of a new baseline

- 5.2.1.1 When it is envisaged by the ERA CCM to bring changes to the ERTMS/ETCS system, it must be assessed whether they impact the system version and, if yes, whether to increment the system version number X or Y.
- 5.2.1.2 Compatibility/incompatibility between two consecutive ERTMS/ETCS system versions shall be evaluated with regard to a set of agreed CRs.
- 5.2.1.3 Each CR from this set shall impact at least one of the TSI annex A documents that are identified as impacting the ERTMS/ETCS system version (see section 4.3.2).

- 5.2.1.4 Each CR, regardless the number of modifications distributed in the different impacted TSI annex A documents, shall be evaluated as a whole, leading to an individual decision with regard to its compatibility/incompatibility. For that purpose, the definitions given in section 5.1 shall be used by assuming that the CR represents the difference between version B and version A.
- 5.2.1.5 If all the evaluated CRs are declared compatible, the new ERTMS/ETCS system version shall be declared compatible with regard to the existing one (Y increment).
- 5.2.1.6 If at least one CR, out of the set of evaluated CRs, is declared incompatible, the new ERTMS/ETCS system version shall be declared incompatible with regard to the existing one (X increment).
- 5.2.1.6.1 Note: to avoid incompatibility, the ERA CCM could decide to reassess, postpone or even rework one or more CRs, thus possibly keeping the versions compatible.

5.3 Evaluation of a single CR

5.3.1 Decision chart

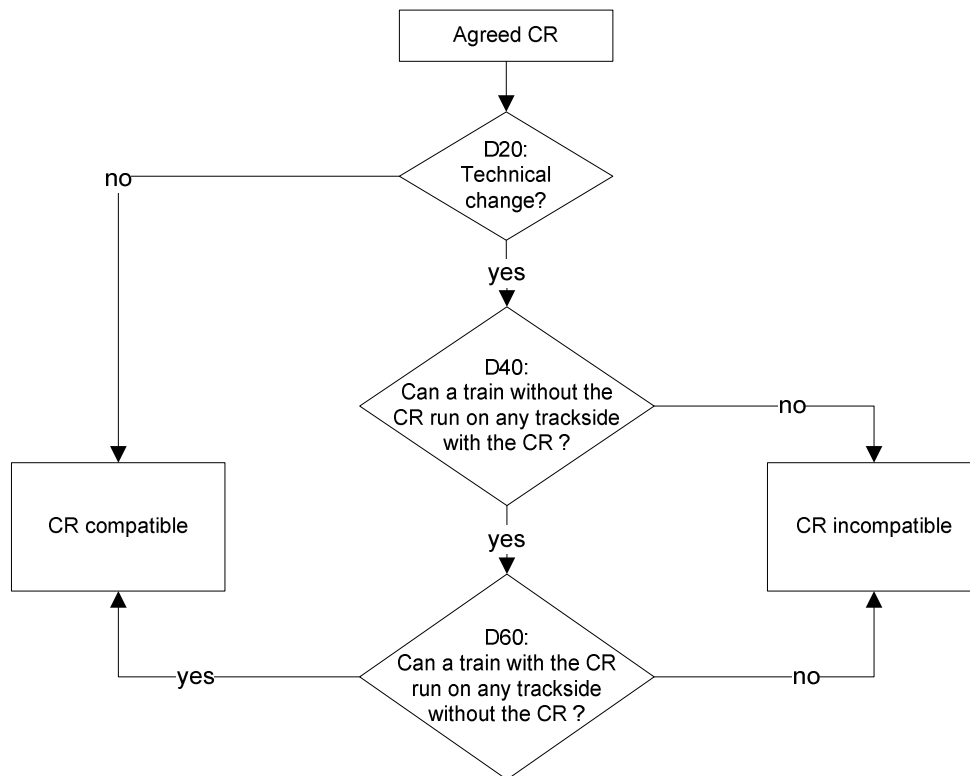

5.3.2 Explanatory table for compatibility/incompatibility decision chart

#	Description
D20	<p>If at least one of the modifications decided in the CR affects the behaviour or the implementation of either ERTMS/ETCS on-board or ERTMS/ETCS trackside, the CR shall be identified as a technical change and the process shall go to D40. Conversely, if all the modifications brought by the CR are purely editorial (wording) or explanatory, the CR shall be identified as an editorial change and shall be declared as compatible.</p>
D40	<p>A technical change shall be evaluated by addressing the following question: “Can a train without the CR run a normal service on any trackside infrastructure where the CR is implemented?”</p> <p>a) If there is no technical, operational or safety related obstacle preventing a train without the CR from running a normal service within any trackside infrastructure, the CR shall go to D60</p> <p>b) if there is at least one technical, operational or safety related obstacle, the CR shall be declared as incompatible.</p> <p>Note: to take into consideration operational and safety aspects for all concerned infrastructures is relevant as long as operational and safety rules are not harmonized.</p>
D60	<p>The evaluation shall be continued by addressing the following question: “Can a train with the CR run a normal service on any trackside infrastructure where the CR is not implemented?”</p> <p>a) If there is no technical, operational or safety related obstacle preventing a train with the CR from running a normal service within any trackside infrastructure, the CR shall be declared as compatible;</p> <p>b) if there is at least one technical, operational or safety related obstacle, the CR shall be declared as incompatible</p> <p>Note: to take into consideration operational and safety aspects for all concerned infrastructures is relevant as long as operational and safety rules are not harmonized.</p>

5.3.2.1 All the decisions listed here above shall be taken in the frame of the ERA CCM.

6. COEXISTENCE OF SYSTEM VERSIONS

6.1 System principles

6.1.1 Introduction

6.1.1.1 Each time any value of the system version number $X.Y$ is incremented, the unavoidable consequences will be, at a given time:

- The coexistence of distinct trackside infrastructures (contiguous or not) operated with different system versions.
- The existence of trackside infrastructures (e.g. level 2/3 areas) where ERTMS/ETCS constituents transmits information marked with a system version different from the one operated.

6.1.1.2 If the increments relate to system version number X , then:

- the on-board equipments must be able to operate with at least two incompatible system versions, in order to run on trackside infrastructures operated with different system version numbers X (see Figure 3) ;
- the on-board equipments must be able to interpret (i.e. to translate) information received from trackside constituents, which is marked with a system version different from the one operated in the concerned trackside infrastructure.

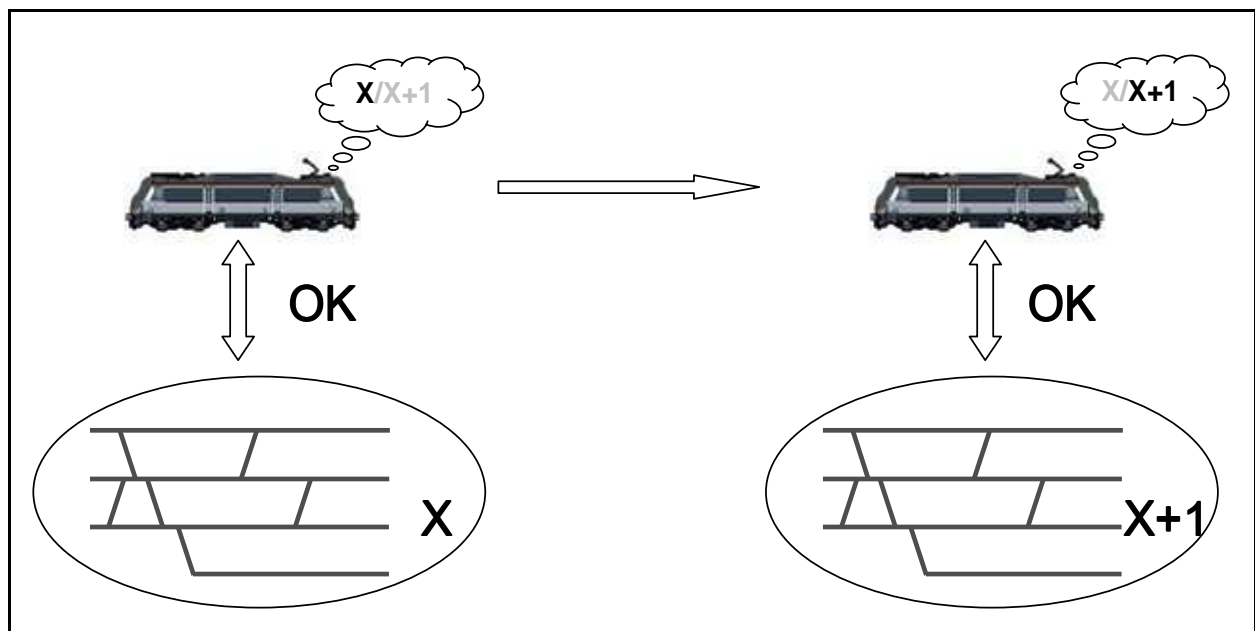

Figure 3: On-board capable to operate with different X system versions

6.1.1.3 On the other hand, coexistence of several compatible system versions, within the same version X , does not yield, by definition, any constraint or limitation to the deployment of ERTMS/ETCS on-board equipments and trackside infrastructures.

6.1.1.4 Going further into the ERTM/ETCS systems lifetime, when at least three incompatible system versions will have been defined, the two apparently antagonist approaches arise:

- a) Limiting to a reasonable value the number of incompatible system versions simultaneously operated in Europe,
 - b) Avoiding unnecessary efforts to upgrade the "non-RBC" trackside components (balises, loops, RIUs).
- 6.1.1.5 A compromise between those two constraints is developed in the next sections of this document and is based on the existence of:
- a) Rules governing the deployment of ERTMS/ETCS trackside infrastructures that limit this number of incompatible system versions simultaneously operated in Europe;
 - b) A maximum flexibility in the management of system version of balise telegrams, loop and RIU messages, both from on-board and trackside point of view.

6.1.2 Legally operated system versions

6.1.2.1 The incompatible system versions, which are allowed to be simultaneously operated in Europe, are defined by the “envelope of legally operated X versions”. This envelope shall be composed of a number of consecutive X versions, and will be subject to evolutions throughout the ERTMS/ETCS system lifetime (see Figure 4).

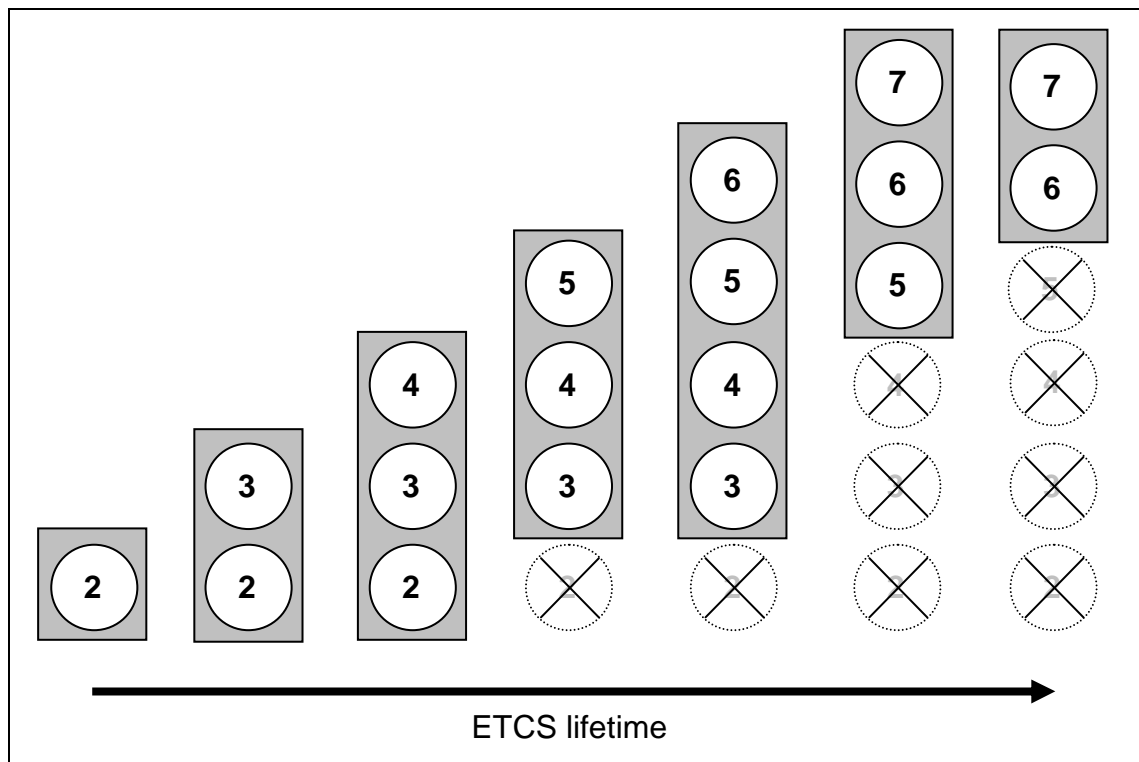

Figure 4: Envelope of legally operated X versions, example of evolution throughout ETCS lifetime

- 6.1.2.2 The composition of the envelope shall be changed when a new ERTMS/ETCS baseline leading to an X increment is proposed (see section 5.2). The possible decisions, illustrated by Figure 4, consist either in:
- a) Incrementing the number of X versions within the envelope, with no X version phasing out, or
 - b) Keeping unchanged the number of X versions within the envelope, by phasing out one X version, or

- c) Reducing the number of X versions within the envelope, by phasing out more than one X version.
- 6.1.2.3 It shall also be possible to change the composition of the envelope when a new ERTMS/ETCS baseline not leading to an X increment is proposed. The possible decision, illustrated by Figure 4, consists in reducing the number of X versions within the envelope by phasing out one or more X versions.
- 6.1.2.4 All the studies and evaluations regarding the envelope shall be undertaken in the frame of the ERA CCM. In particular, the driving factors having led to a decision about the envelope shall be part of the dossier supporting a new baseline.
- 6.1.2.4.1 Note: even if it is not in the scope of this document to establish the criteria (technical, operational, economic,...) used to assess the composition of the envelope, guidelines are given in annex A.
- 6.1.2.5 The Figure 4 here above only shows an example of different envelopes of legally operated X versions, which correspond to stabilised situations. How these stabilised situations are reached and hence how the transition periods (migration strategies) between them are organised is described in chapter 7 of this document.

6.1.3 Uniqueness of the reference baseline

- 6.1.3.1 The legally operated ERTMS/ETCS system versions (including the intermediate compatible versions, if any) shall be embodied in a single baseline of the TSI annex A.
- 6.1.3.2 The composition of the envelope of X versions, complemented by the possible Y versions, shall be specified in the SRS. All the requirements listed in the TSI annex A documents shall by default be applicable to all the legally operated system versions, unless otherwise specified.
- 6.1.3.3 The specific requirements relative to the older versions (i.e. which are applicable to ERTMS/ETCS trackside and/or on-board equipment operating any version of the envelope, which is older than the last one introduced) shall be specified accordingly in the same release of each concerned TSI annex A document.
- 6.1.3.3.1 Note: depending on the type of change between the different system versions, this may consist in a limited number of requirements:
 - a) to be marked as “not applicable” for the concerned older system version, or
 - b) where the older/different version of the concerned clauses prevails.

6.2 Coexistence of incompatible system versions: trackside infrastructures

6.2.1 Principles

- 6.2.1.1 ERTMS/ETCS infrastructures shall be operated with a system version number X belonging to the current envelope of legally operated X versions.
- 6.2.1.2 To operate a system version X within a trackside area does not imply that all the fitted "non-RBC" trackside components (balises, loops, RIUs) must transmit information marked with the same version number X; in that respect, it shall be possible to fit the

concerned trackside area with balises, loops or RIUs transmitting information marked with a different version number X, which:

- a) is inside the envelope of legally operated X versions;
- b) is outside the envelope of legally operated X versions and obsolete, provided that the transmitted telegrams/messages include information that the on-board equipment is able to interpret (see SUBSET-026 chapter 6 for details).

6.2.1.3 In all levels and at all suitable locations, it shall be possible for ERTMS/ETCS trackside to order the operated system version to the ERTMS/ETCS on-board equipment (see SUBSET-026 section 3.17 and chapter 7 for details).

6.2.1.3.1 Justification: this is needed for all levels, including level 2/3 to cope with master engines in degraded situation and with slave engines.

6.2.2 Example

6.2.2.1 Introduction

6.2.2.1.1 This section aims at describing the examples of different possible trackside configurations that can be found from a snapshot of the whole Trans-European Network, when three incompatible ERTMS/ETCS system versions have been defined.

6.2.2.1.2 This example assumes that, when this snapshot is taken, two incompatible system versions are legally operated, and that the oldest system version was phased out in the past (i.e. is now obsolete).

6.2.2.1.3 Trans-European Network can be seen, from ERTMS/ETCS point of view, as a big level 0/STM desert, with a few level 1 or 2 oases, actually the only ones to be recognised as operated with ERTM/ETCS (see Figure 5).

6.2.2.1.4 In the next sections, a closer look is taken on those areas, showing various possible combinations of ERTM/ETCS trackside constituents, with regard to their system version number. For clarity reasons, the two legally operated system versions are identified as 3.0 and 4.0, whilst the obsolete system version is 2.0.

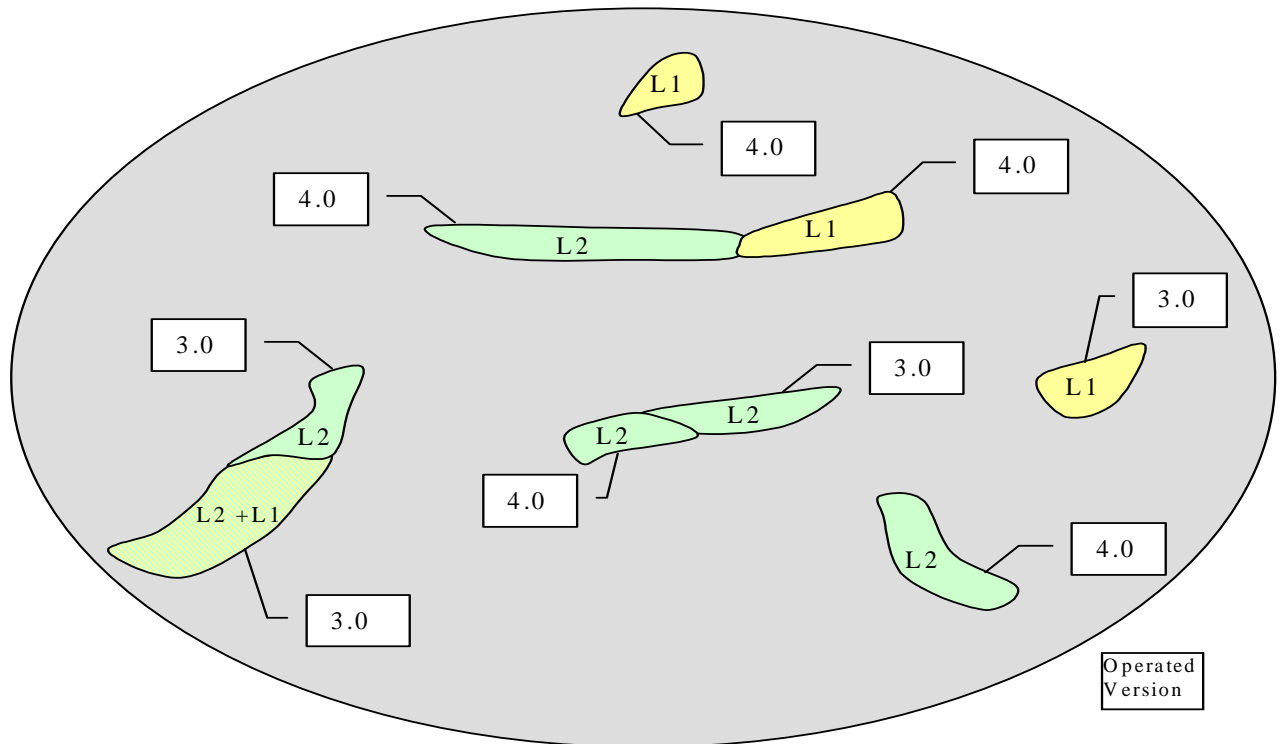

Figure 5 : Snapshot of ERTMS/ETCS Trans European Network

6.2.2.1.5 Important remark: in the following sections, border balise groups (including level transition and/or RBC transition orders) are considered as being part of both neighbouring areas; indeed, these balise groups include different information valid for each direction pointing towards the concerned area.

6.2.2.2 Level 2/3 areas

6.2.2.2.1 Within a level 2/3 area, the granularity of operated system version is the RBC area, because RBC imposes the version to be operated and transmits all its messages related to a unique system version (see Figure 6).

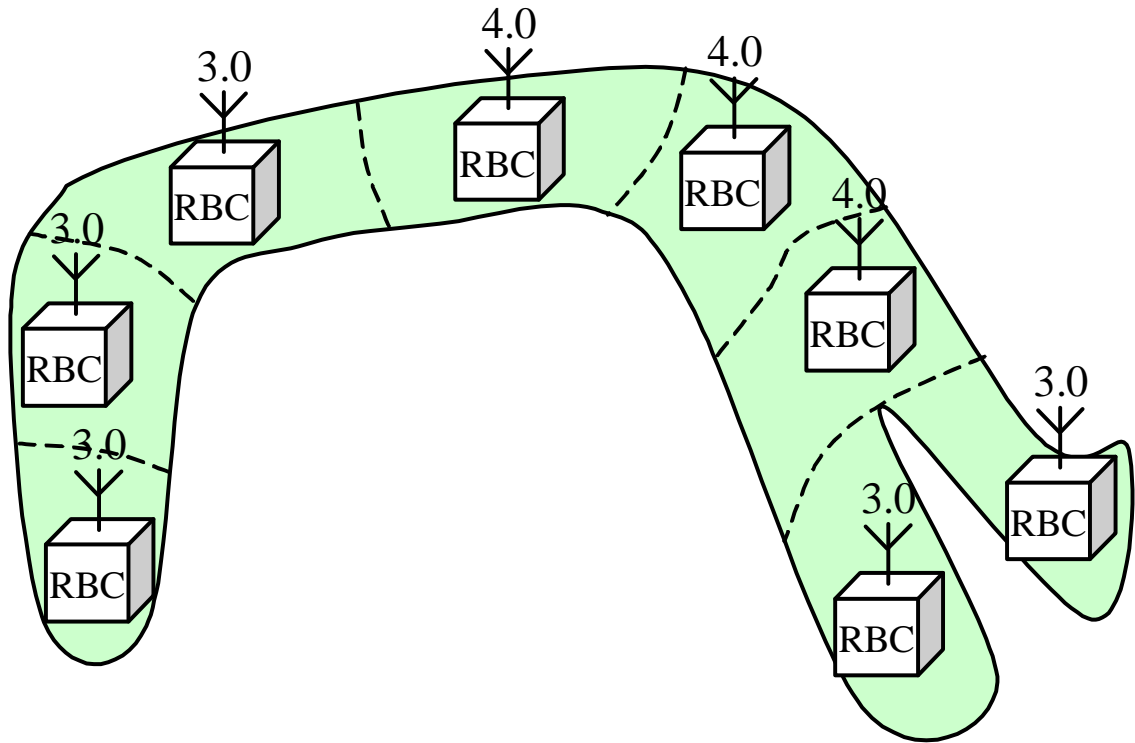

Figure 6: granularity of operated system version for level 2/3 area

6.2.2.2.2 Within a level 2/3 area, the only other ERTMS/ETCS constituents are balises; most of them are installed for relocation purpose and transmit no packet at all, whilst some of them include packet(s) that might be impacted by a system version upgrade.

6.2.2.2.3 Case 1: homogeneous RBC area

6.2.2.2.3.1 All the balise telegrams have been elaborated with the same system version as the RBC; this is the case of a RBC area, which has been installed and commissioned after the operated version has been legally enforced.

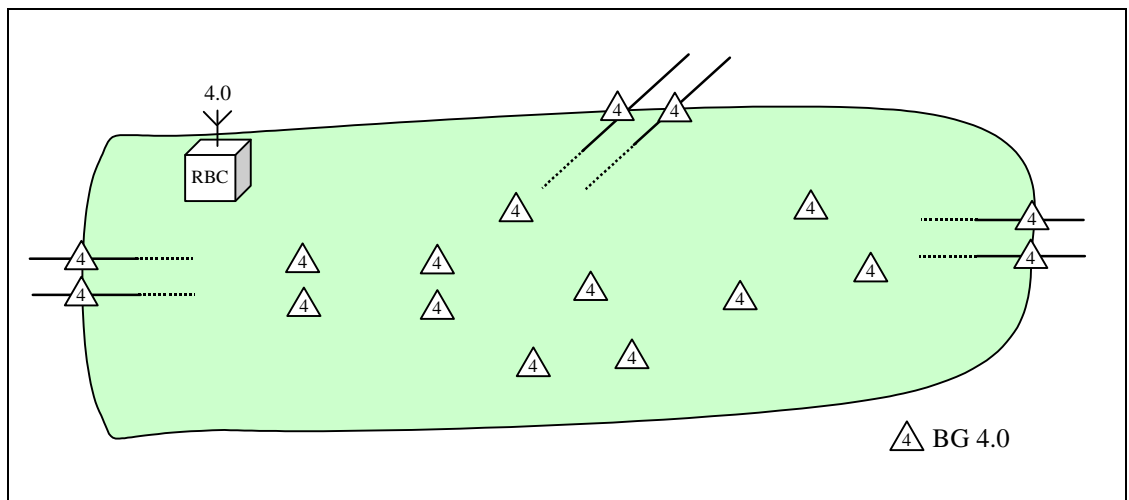

Figure 7: homogeneous RBC area

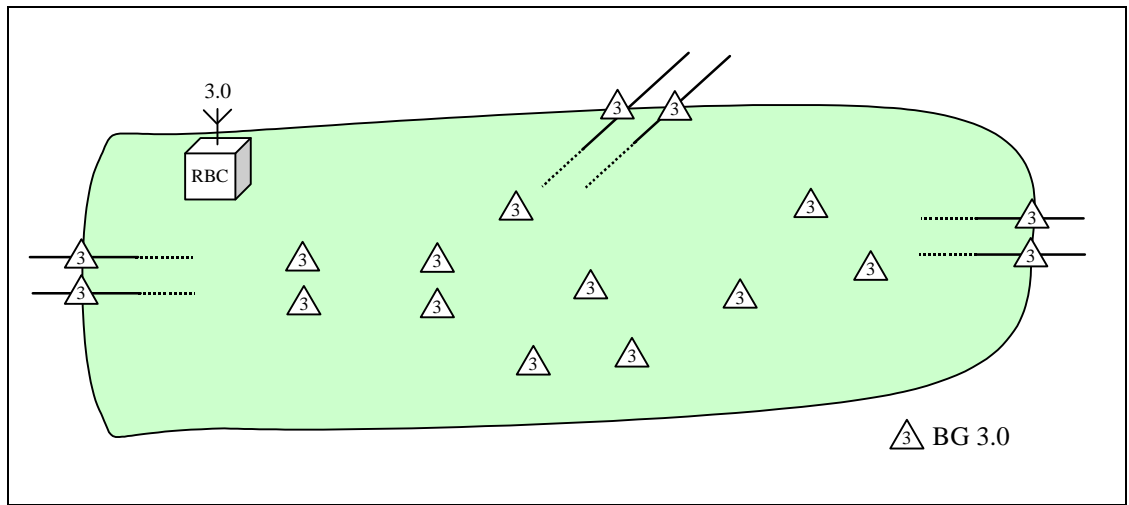

Figure 8: homogeneous RBC area

6.2.2.2.4 Case 2: Up to date RBC with older but non obsolete balises

6.2.2.2.4.1 This is the case of an RBC area commissioned with the previous but still legally operated system version, where the RBC has been upgraded first, together with a few balises transmitting information proper to the new system version.

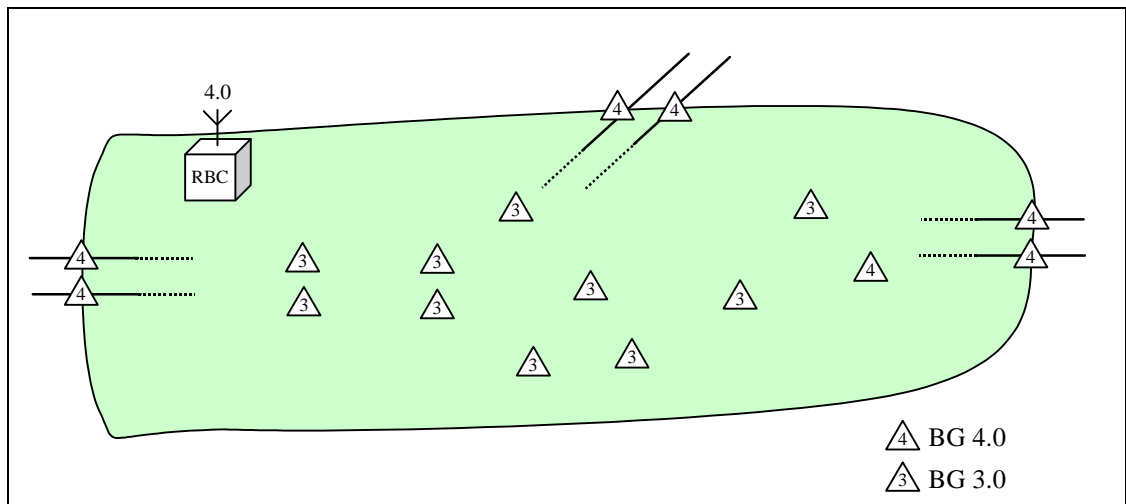

Figure 9: RBC 4.0 with balises 4.0 & 3.0

6.2.2.2.5 Case 3: Up to date RBC with older obsolete balises

6.2.2.2.5.1 This is the case of an RBC area commissioned with a previous but obsolete system version, where the RBC has been upgraded twice, each time together with a few balises transmitting information proper to the new system version.

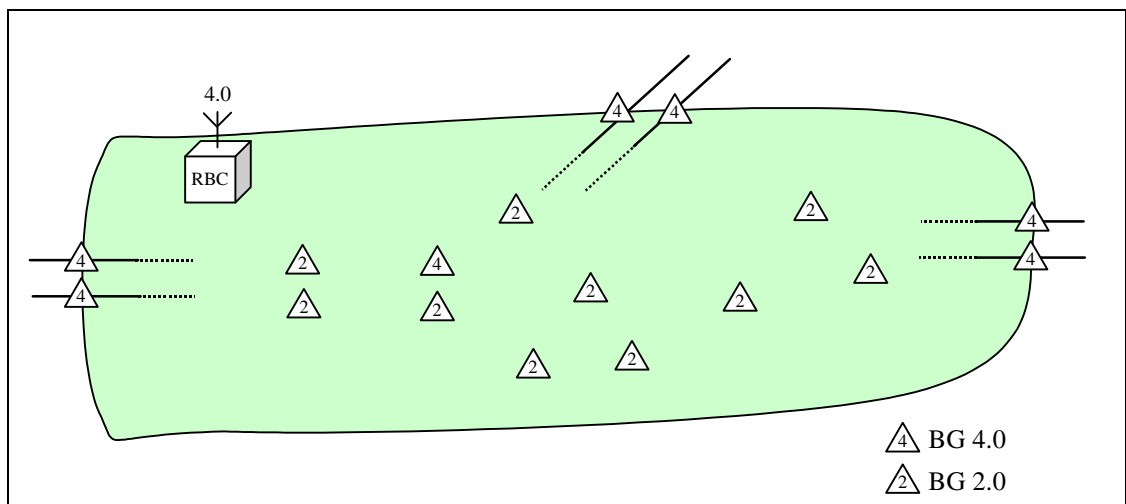

Figure 10: RBC 4.0 with balises 4.0 & 2.0

6.2.2.2.6 Case 4: Up to date RBC with older non obsolete and older obsolete balises

6.2.2.2.6.1 This is the case of an RBC area commissioned with a previous but obsolete system version, where the RBC has been upgraded twice. Some balises have been upgraded to the latest version, while some others still transmit information related to previous but legally operated system version.

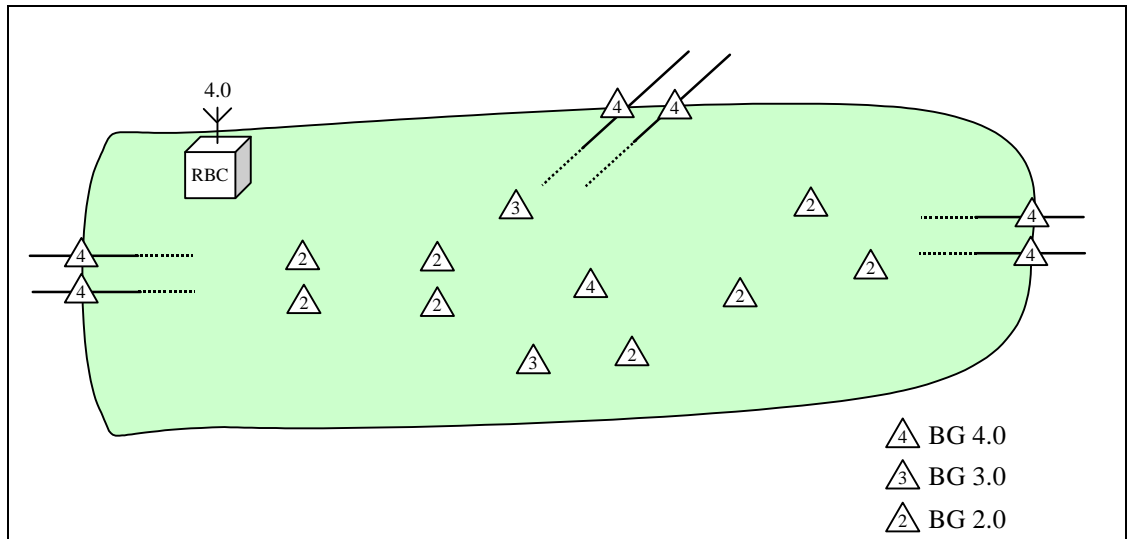

Figure 11: RBC 4.0 with balises 4.0, 3.0 & 2.0

6.2.2.2.7 Case 5: Non up to date RBC with newer balises

6.2.2.2.7.1 This is the case of an RBC area commissioned with a previous but still legally operated system version. During the migration period to the latest version, some balises have been upgraded, prior to the RBC upgrade.

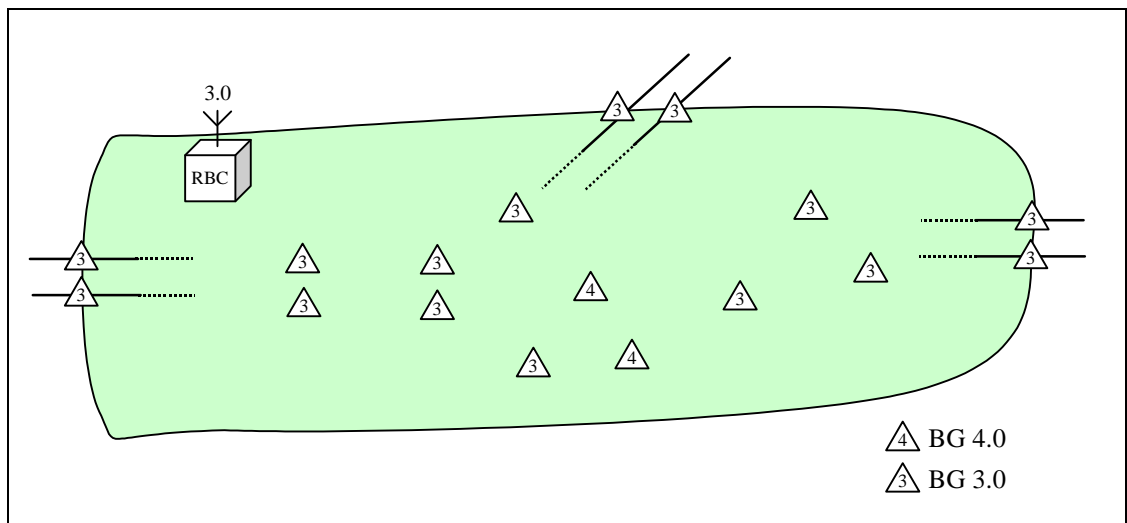

Figure 12: RBC 3.0 with balises 3.0 & 4.0

6.2.2.2.8 Case 6: Non up to date RBC with older obsolete balises

6.2.2.2.8.1 This is the case of an RBC area commissioned with a previous system version now obsolete, where the RBC has been upgraded once. Some balises were upgraded to the older but still legally operated system version, because they include information proper to this version.

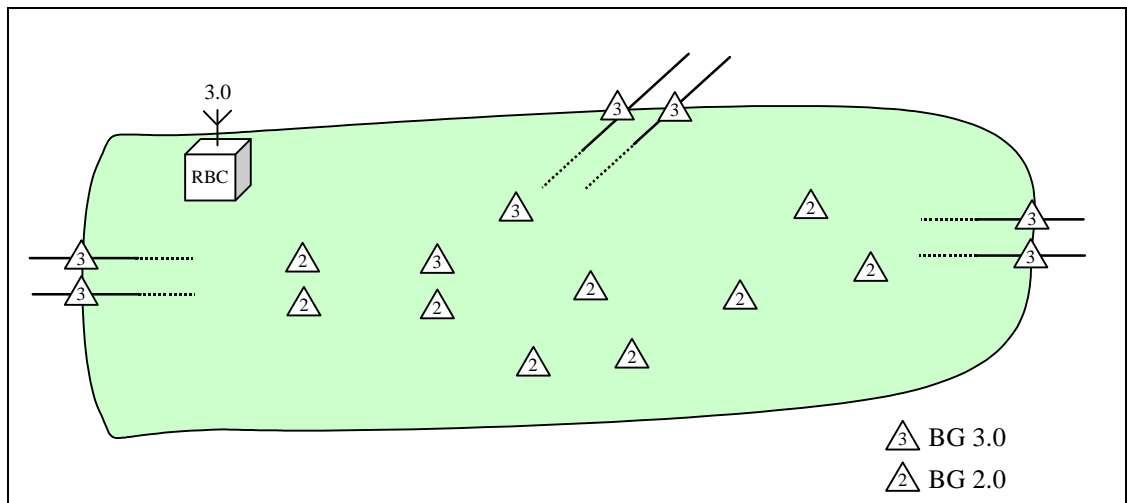

Figure 13: RBC 3.0 with balises 3.0 & 2.0

6.2.2.2.9 Case 7: Non up to date RBC with newer balises and older obsolete balises

6.2.2.2.9.1 This is the case of an RBC area commissioned with a previous system version now obsolete, where the RBC has been upgraded once. Some balises were upgraded to the older but still legally operated system version; during the migration period to the latest version, some others balises have been upgraded, prior to the RBC upgrade.

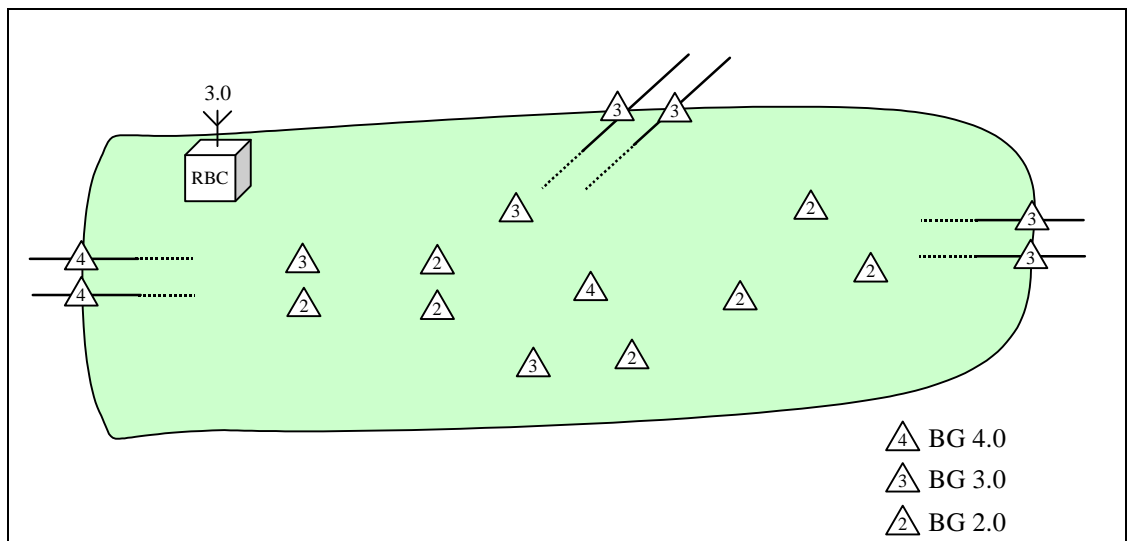

Figure 14: RBC 3.0 with balises 4.0, 3.0 & 2.0

6.2.2.2.10 Case 8: Contiguous RBC areas operated with different system versions

6.2.2.2.10.1 This is the case of a level 2/3 area where an RBC migration plan is ongoing, either conducted by one single supplier or by two different suppliers.

6.2.2.2.10.2 It is assumed that border balise groups have been upgraded to the newest system version, in order to include the system version order packet.

6.2.2.2.10.3 It is also assumed that the RBC, which is upgraded to the newest version, is able to transmit/receive RBC/RBC messages in the RBC/RBC language corresponding to the system version of the other RBC, if necessary.

6.2.2.2.10.3.1 Note: this is not in contradiction with SUBSET-026 § 3.17.3.2 and is needed in order to perform smooth RBC/RBC Handover.

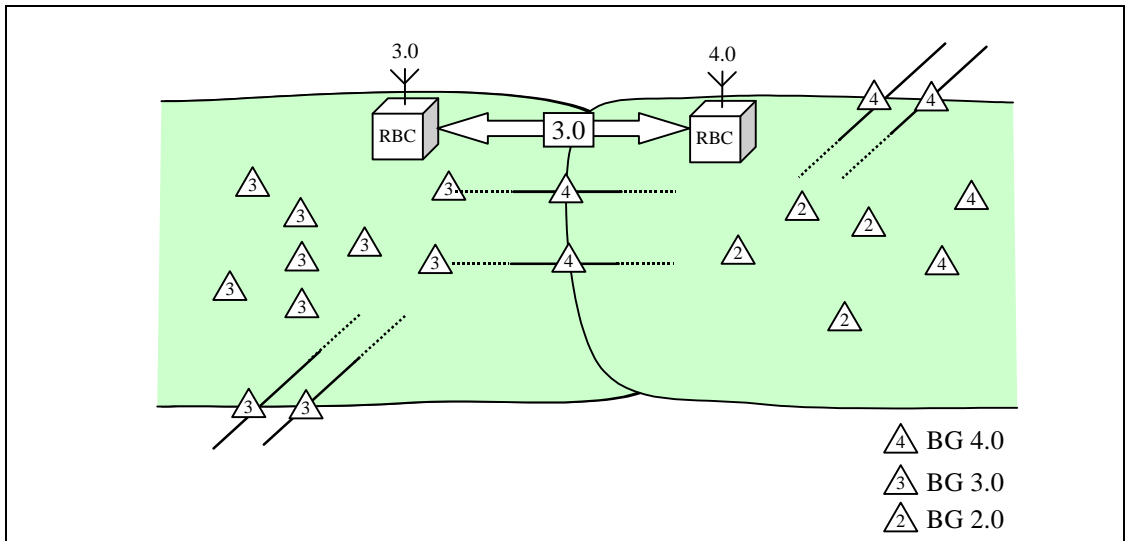

Figure 15: RBC 3.0 contiguous to RBC 4.0

6.2.2.3 Level 1 areas

6.2.2.3.1 In contrast to level 2/3 area, the granularity of operated system version for level 1 area is not technically limited and entire freedom is left to infrastructure owner. Nevertheless, it is expected that this granularity should not be finer than a signalling block, for obvious operational reasons.

6.2.2.3.2 The different cases studied for level 2/3 areas (except for case 8 where the interfacing of two RBCs certified to a different version is irrelevant) can be transposed to level 1 areas, going from the simplest configuration (the homogeneous area) to the most complex one (see Figure 16); the main differences are:

- a) The size of an elementary area operated with a given system version can be anything, from the entire level 1 area to a single signalling block.
- b) In-fill devices (loops and RIUs) may be used

6.2.2.3.3 Another particularity, proper to level 1 trackside engineering, may arise for balise groups: the possibility that telegrams transmitted by the balises of a same group have not been marked with the same system version; indeed, many level 1 balise groups are composed of one switchable balise and one fixed balise, this latter being used only for determining the direction of the balise group or containing fixed information. The temptation not to upgrade this fixed balise is naturally reinforced by the fact that, in most of the cases, the switchable balise information is remotely upgraded.

6.2.2.3.3.1 Note: the mixed balise group with regard to system version are also technically possible for other levels, but the gain in terms of upgrading costs is probably less significant.

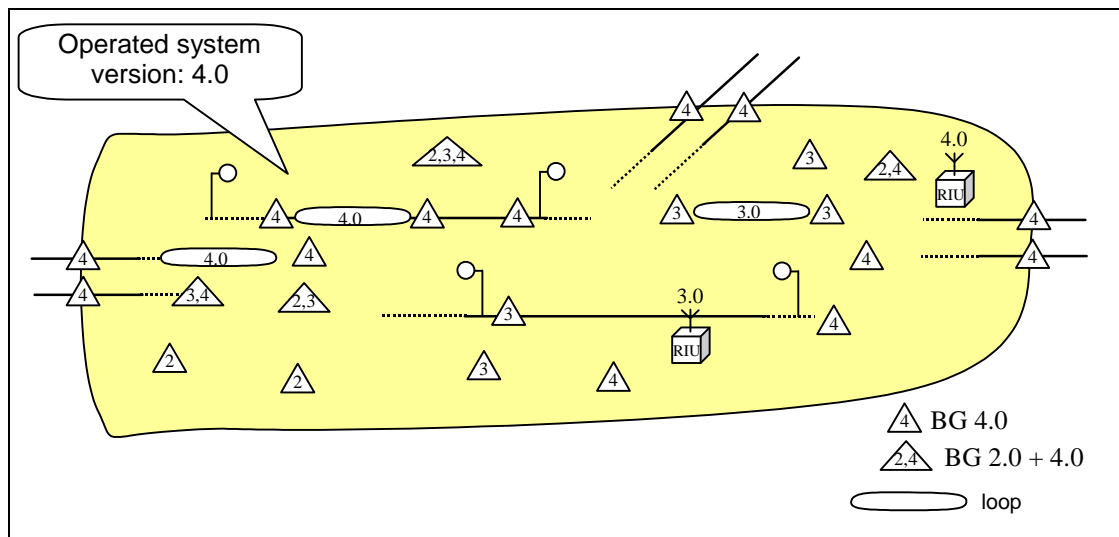

Figure 16: level 1 area with all possible combinations

6.2.2.4 Mixed Level 1 + 2 areas

- 6.2.2.4.1 Within a mixed level 1 + 2 area, the granularity of operated version for level 1 can in theory be defined independently from the RBC area decomposition. This superimposition can be worked out because in level 2, when a session is established with RBC, on-boards disregards the operated system version management ordered by balise groups (see SUBSET-026 § 3.17.2.8).
- 6.2.2.4.2 As a result, what is described for level 1 and level 2/3 areas here above remain valid and can be combined.

6.2.3 Level 0/STM areas

- 6.2.3.1 When exiting the ERTMS/ETCS fitted areas towards level 0/STM areas, on-board equipment shall be ordered to operate the lowest system version of the envelope of legally operated system versions.
- 6.2.3.2 This principle does not prevent from ordering a different behaviour for a specific sub area, provided that the default behaviour is re-ordered again when the train leaves this area.

6.3 Coexistence of compatible system versions: trackside infrastructures

- 6.3.1.1 With regard to system version number Y, any combination of trackside constituents is possible from the larger scale (Trans European Networks) to the smaller one (the balise group), without any influence on the system version operated by on-board equipment.
- 6.3.1.2 For level 2/3 areas only: if the system versions of two interconnected RBCs only differ by numbers Y, the RBC with the newest system version shall apply the appropriate mitigation measures for the Route Related Information messages (e.g. providing to the receiver an alternative information to the ETCS language add-on defined in the new system version).

6.4 Coexistence of compatible/incompatible system versions: on-board equipments

- 6.4.1.1 The on-board equipment shall be able to operate with (i.e. shall support) any of the incompatible ERTMS/ETCS system versions included in the envelope that is part of the TSI release to which it has been certified.
- 6.4.1.2 If, between two consecutive incompatible system versions of the envelope, at least one compatible version has been defined, the on-board equipment shall be able to operate with (i.e. shall support) any of the system version number Y, within the lower system version number X.
- 6.4.1.2.1 Justification: this is due to the fact that the evolution of the system version is purely sequential and that no branch is possible.

7. MIGRATION STRATEGY

7.1 Introduction

- 7.1.1.1 The aim of this section is to define the transitional measures that must accompany a release of the TSI annex A, in case this latter encloses a modification of the envelope of legally operated X versions. These measures consist of mandatory steps that must be respected by all the stakeholders in Europe, for upgrading the ERTMS/ETCS constituents.
- 7.1.1.2 These mandatory steps are only intended to prevent individual initiatives or collusions that could harm interoperability or distort competition. It is however not in the scope of this chapter to describe the detailed migration phases of individual projects.
- 7.1.1.3 The evolution of the ERTMS/ETCS system version is purely sequential. Any intermediate upgrades of system version number Y that can take place between two consecutive version numbers X, have no influence on what follows. Consequently, the rest of this chapter must be understood as if the system version was referenced with the number X only.

7.2 Migration models

7.2.1 Model 1: new X version with no phasing out of older X version

- 7.2.1.1 Starting when the new TSI becomes applicable, an initial transition period (δ_{LOP}) shall be defined, to allow flexibility for the first preparation of the products.
- 7.2.1.2 During this initial transition period, all the Infrastructure Managers shall not be allowed to deploy constituents transmitting information marked with the new X version, on any level 1, 2 or 3 line operated in commercial service. Only when it expires, the new X version becomes legally operable.
- 7.2.1.3 Any Infrastructure Manager who aims at operating the new X version shall notify its intention to do so.
- 7.2.1.3.1 It is not in the scope of this document to specify how this public notification is handled (e.g. through the interoperability register of infrastructure).
- 7.2.1.4 The Railway Undertakings, which have to operate on a notifying infrastructure, shall fit their fleets with ETCS on-board equipments supporting the new envelope of X versions, within a compliance period. This compliance period:
- Shall start from the notification time (t_{not_IM}) of the Infrastructure Manager
 - Shall not be shorter than a fixed nominal value ($\delta_{nomcomp_RU}$), which shall be unique for the new envelope of X versions
 - Shall not end before the initial transition period expires
- 7.2.1.5 Until the compliance period expires, the concerned Infrastructure Manager shall not be allowed to deploy constituents transmitting information marked with the new X version, on any level 1, 2 or 3 line operated in commercial service.

- 7.2.1.6 The Figure 17 illustrates the requirements here above, with an example of a transition from an envelope composed of three versions {2+3+4} to an envelope composed of four versions {2+3+4+5}.
- 7.2.1.6.1 In Figure 17, the green arrows represent the migration period during which an IM deploys constituents transmitting information marked with the new X version and switches the operated system version.
- 7.2.1.7 For further information about migration parameters, see annex B.

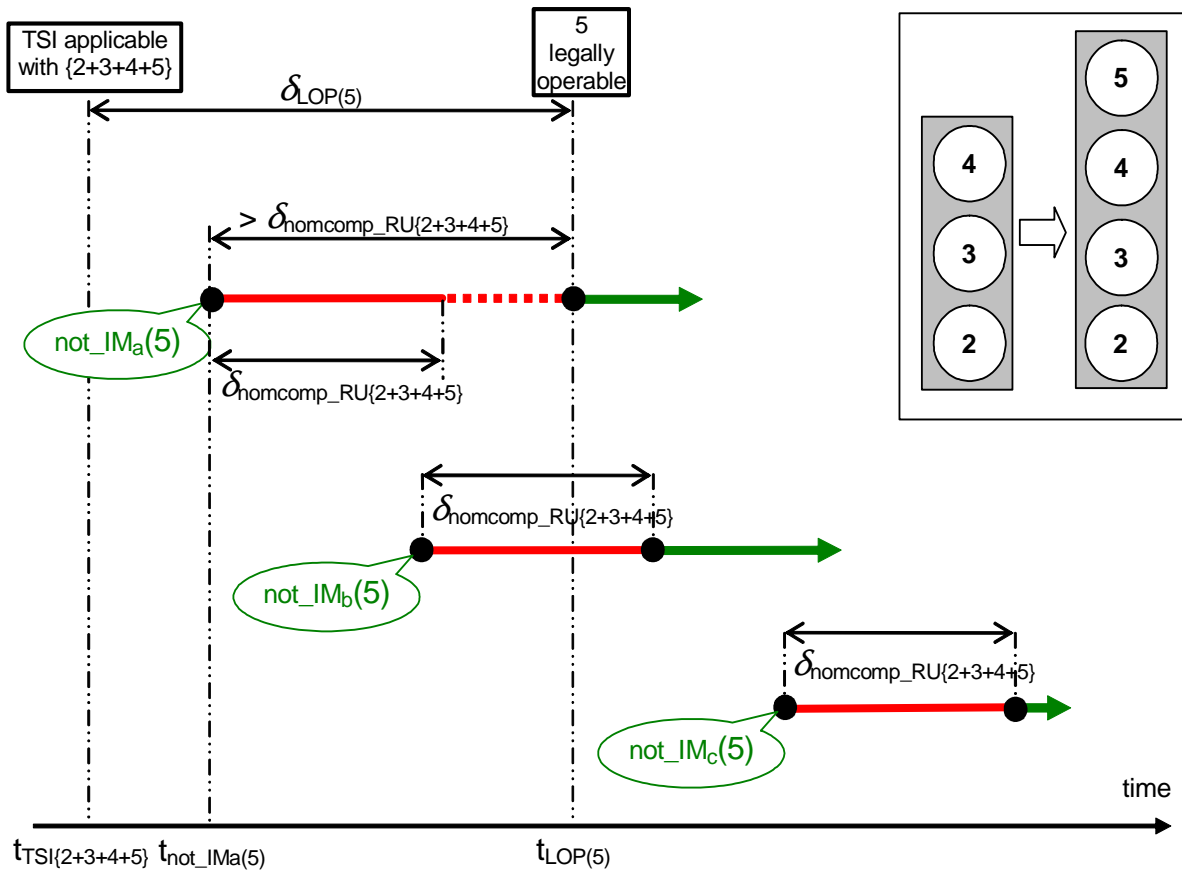

Figure 17: creation of new X version, with no phasing out

7.2.2 Model 2: new X version with phasing out of oldest X version

7.2.2.1 The period of version phasing out (δ_{PO}) shall be composed of three sequential phases, see details in table below.

Mandatory steps for phasing out of X version			
Phase	Triggering event	Requirements	Final situation
I	TSI including the new envelope becomes applicable $t_{TSI\{new\ envelope\}}$	If there is more than one common version between the old and the new envelope, each IM still operating version to be phased out shall notify, within a fixed notification period (δ_{not_IM}), which intermediate version it will operate in a first step. If there is only one common version between the old and the new envelope, the notification for this common version shall automatically be considered as immediate (i.e. $\delta_{not_IM} = 0$).	All concerned RUs are notified
II	Phase I expires $t_{TSI\{new\ envelope\}} + \delta_{not_IM}$	RUs, which have to operate on a notifying infrastructure and which do not support the intermediate notified version, shall fit their fleets with ETCS on-board equipments supporting the previously applicable envelope of X versions, within the nominal compliance period previously defined for this envelope ($\delta_{nomcomp_RU\{prev\ envelope\}}$) During the compliance period, the concerned IMs shall not be allowed to deploy constituents transmitting information marked with the notified intermediate X version, on any level 1, 2 or 3 line operated in commercial service	All ETCS on-board equipments shall support the envelope of X versions applicable as per previous TSI release
III	Phase II expires $t_{TSI\{new\ envelope\}} + \delta_{not_IM} + \delta_{nomcomp_RU\{prev\ envelope\}}$	IMs shall deploy ETCS constituents transmitting information marked with the notified intermediate X version and shall switch the operated version, within a fixed migration period (δ_{dep_IM})	Obsolete version is phased out

7.2.2.2 The completion of these three sequential phases defines the official time of version phasing out (t_{PO}), after which it shall be forbidden to operate the obsolete version.

$$t_{PO} = t_{TSI\{new\ envelope\}} + \delta_{PO}$$

$$\text{where } \delta_{PO} = \delta_{not_IM} + \delta_{nomcomp_RU\{prev\ envelope\}} + \delta_{dep_IM}$$

7.2.2.3 For the migration to the new X version, the requirements listed in section 7.2.1 shall be applicable, with an initial transition period defined as the sum of:

- a) the phasing out period of the oldest X version
- b) a deployment period for installation of on-board equipments supporting the new envelope of X versions

$$\delta_{LOP} = \delta_{PO} + \delta_{dep_RU\{new\ envelope\}}$$

7.2.2.3.1 Justification: Railway Undertakings, which have to operate on an infrastructure where the oldest version is being phased out, can not start the deployment of on-board equipments supporting the new envelope on their fleets, before this old version is completely phased out.

7.2.2.4 The Figure 18 illustrates the requirements here above, with an example of a transition from an envelope composed of three versions {2+3+4} to an envelope composed of three versions {3+4+5} and with phasing out of version 2.

7.2.2.4.1 In Figure 18, the green arrows represent the migration period during which an IM deploys constituents transmitting information marked with the new X version and switches the operated system version.

7.2.2.4.2 In Figure 18, IM_a has notified its intention to migrate to version 5, while the version 2 is being phased out on its infrastructure; therefore the RUs operating on this infrastructure cannot start to deploy on-board equipments supporting the new envelope {3+4+5} before the version 2 is completely phased out.

7.2.2.4.3 In Figure 18, IM_b has notified its intention to migrate to version 5, while the version 2 is being phased out on a neighbouring infrastructure; therefore the RUs operating both on this neighbouring infrastructure and the infrastructure of IM_b cannot start to deploy on-board equipments supporting the new envelope {3+4+5} before the version 2 is completely phased out. On the other hand, RUs that do not operate on another infrastructure where the version 2 is being phased out can deploy on-board equipments supporting the new envelope {3+4+5}, independently from the phasing out of version 2.

7.2.2.5 For further information about migration parameters, see annex B.

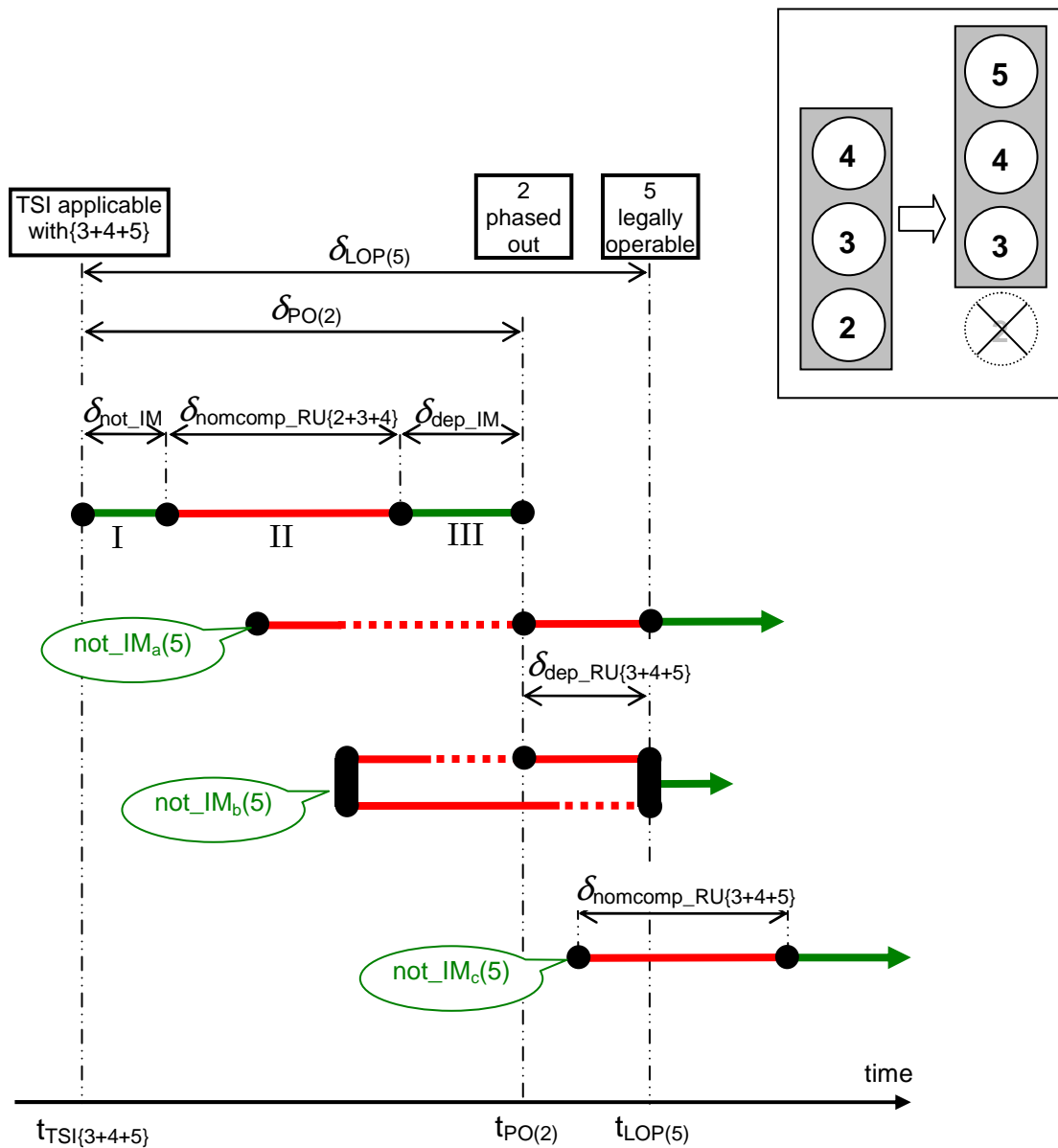

Figure 18: Creation of new X version, with phasing out of oldest version

7.2.3 Model 3: Phasing out of oldest X version with no new X version

- 7.2.3.1 The decision to phase out the oldest X version without introducing a new X version may arise from time to time in order to help avoid the need for two upgrades in a short period of time, which would apply to IMs that remained at the oldest version and to RUs that remained at an older envelope.
- 7.2.3.2 Requirements 7.2.2.1 and 7.2.2.2 shall be applicable, for the phasing out of the version.
- 7.2.3.3 The Figure 19 illustrates the requirements here above, with an example of a transition from an envelope composed of three versions {2+3+4} to an envelope composed of two versions {3+4}, i.e. the phasing out of version 2.
- 7.2.3.4 For further information about migration parameters, see annex B.

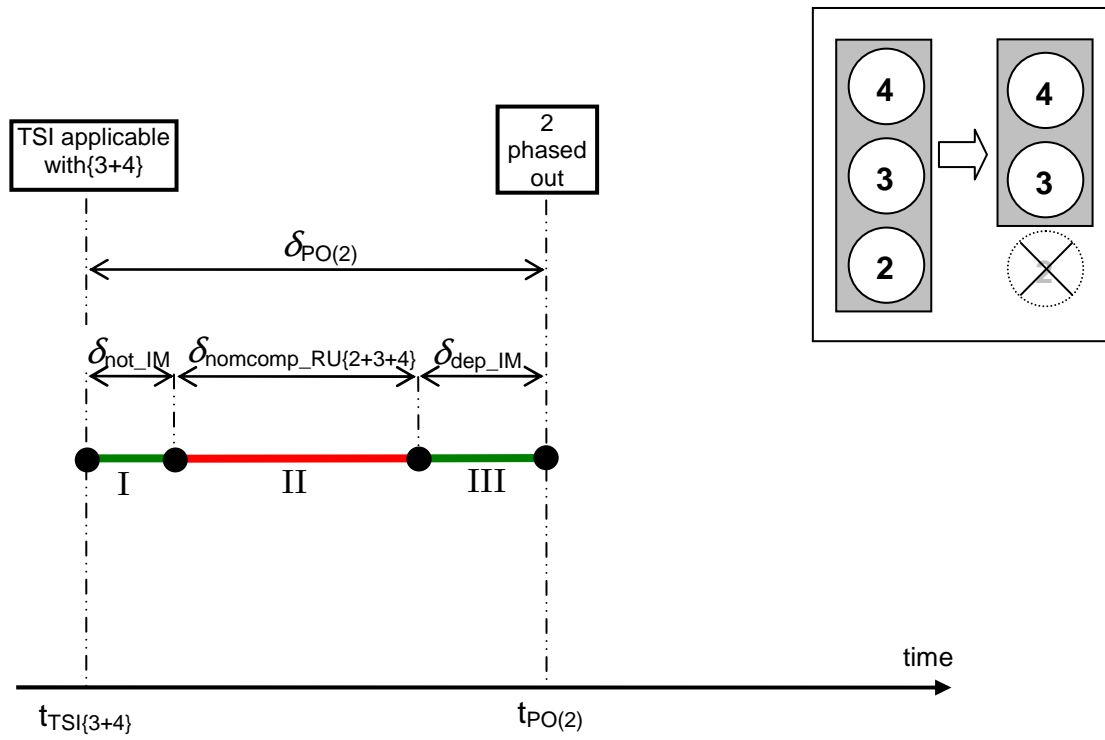

Figure 19: Phasing out of oldest version, with no creation of new X version

8. ANNEXES

8.1 Annex A: Guidelines for assessment of the size of the envelope of legally operated X versions

8.1.1 Introduction

8.1.1.1 The concept of envelope of legally operated X versions introduces a limit on the number of X versions that can co-exist. This annex proposes criteria that may be used to help assess such a limit.

8.1.2 Context

8.1.2.1 As the specification for ETCS moves towards harmonisation and maturity, a number of changes to scope, functionality and operation are likely to be introduced from time to time that will be reflected in new System Versions.

8.1.2.2 This document has adopted the principle of a train being able to operate with the new X version and already existing X versions, which actually provides a backwards compatibility between X versions.

8.1.2.3 For an interoperable route (e.g. a corridor) a possible scenario is that an initial installation for infrastructure and trains was all made at System Version X_1 . Subsequent extensions to the route were made at times when new System Versions had been approved and issued in the TSI annex A, so that the extended corridor has sections of infrastructure operated with $X_1, X_2 \dots X_n$, with the trains capable to support $X_1, X_2 \dots X_n$. What is the limit for 'n', i.e. how many incompatible System Versions can be permitted to co-exist?

8.1.3 Technical criteria

8.1.3.1 There are two technical scenarios that could limit the size of the envelope of legally operated X versions ('n'):

- a) Where the changes required to the software to maintain backwards compatibility are very complex – i.e. where simply adding new functions does not satisfy the changes and the interaction with existing functions needs to be modified. In this circumstance the prospect of 'collateral damage' may give rise to a software re-write and this would be a natural time to consider the full scope of the System Version.
- b) Where the new Version requires changes to the hardware installed. The new Version may require new memory or processing power and the introduction of new computing capacity raises the prospect of new software. Component obsolescence could also be a cause for hardware modifications. While this does not automatically restrict the number of Versions, if the software has to be significantly re-written to run on the new hardware this could restrict the number of older Versions included, simply on economic grounds of avoiding the costs of rewriting and validating obsolete functions.

8.1.3.2 It is reasonable to assume that such situations would be supplier specific, depending on the nature of the particular solutions offered.

8.1.3.3 This, in turn, may lead to consideration of seeking 'life guarantees' for an installed Version. However, to achieve compatibility between different suppliers' trackside and on-board sub-systems, this may only be workable if a 'blanket' minimum Version validity period is endorsed by the sector.

8.1.4 Economic criteria

8.1.4.1 It is assumed that the acceptance of Change Requests and the approval of any new X versions are underpinned by positive economic impact assessments. However, upgrading the infrastructure and trains of a route that is already operated with an earlier X version will fall into the following possible scenarios, which induce benefits and/or are business case driven:

- a) Where the functionality of the new Version offers attractive benefits to both IM & RU that offset the costs of upgrade
- b) Where the benefits are attractive mainly to the RU and the IMs upgrade because of competition for RU business (where there are alternative routes via a different IM)
- c) Where the benefits are attractive to the RU and the IM is given incentives through the access charge regime.

8.1.5 Operational criteria

8.1.5.1 Operating ERTMS in interoperable cross-border traffic will require harmonised operating rules. These rules will have to cater for differences in the operation under consecutive versions of the system. These differences will have to be evaluated according to the following criteria:

- a) Has the system changed in a way that requires different rules depending on the version under which the system operates?
- b) Can it be difficult for the user of the system to select the right operating rules for the appropriate version?
- c) Is the total set of rules getting too complex for the users?
- d) Can the application of the rule for the wrong version lead to a significant disturbance of traffic?
- e) Can the application of the rule for the wrong version lead to a safety risk?

8.1.5.2 If one of these questions is answered with yes, a reduction of the envelope will have to be considered.

8.1.6 Direction or Regulation criteria

8.1.6.1 Whilst it may be preferable to adopt one of the criteria described here above, this may not always be successful. Therefore, there may be circumstances where a central 'governing mind' determines that it is now 'right' or 'appropriate' for routes or sections to be upgraded to the current Version for the 'greater good' of all.

8.2 Annex B: Migration parameters

8.2.1 Introduction

8.2.1.1 The values of the migration parameters described here below are to be defined in the frame of the ERA CCM, each time a dossier for a new baseline is prepared. Indicative values are only given here for readability purpose.

8.2.2 Model 1: new X version with no phasing out of older X version

8.2.2.1 Let the new envelope of X versions enforced in the TSI be $\{X_n+X_{n+1}+X_{n+2}+X_{n+3}\}$, in place of the previous envelope $\{X_n+X_{n+1}+X_{n+2}\}$; X_{n+3} is the new version to be legally operated; the table here below gives indicative values for the migration parameters.

Parameter	Description	Indicative value(year)
$\delta_{LOP}(X_{n+3})$	Duration of the initial transition period, derived from the minimum time left to RUs and suppliers to implement the new version for the first time in the products. During this initial transition period, IMs shall not be allowed to deploy ETCS constituents transmitting information marked with the new version X_{n+3} .	>2
$\delta_{nomcomp_RU}\{new\ envelope\}$	Duration of the nominal compliance period left to RUs to fit their fleets with ETCS on-board equipments supporting the new envelope. This nominal compliance period includes contracting, design, certification, prototyping, tests and deployment phases.	2

8.2.3 Model 2: new X version with phasing out of oldest X version

8.2.3.1 Let the new envelope of X versions enforced in the TSI be $\{X_{n+1}+X_{n+2}+X_{n+3}\}$, in place of the previous envelope $\{X_n+X_{n+1}+X_{n+2}\}$; X_{n+3} is new version to be legally operated and X_n is the obsolete version to be phased out; the table here below gives indicative values for the migration parameters.

Parameter	Description	Indicative value(year)
$\delta_{nomcomp_RU}\{new\ envelope\}$	Duration of the nominal compliance period left to RUs to fit their fleets with ETCS on-board equipments supporting the new envelope. This nominal compliance period includes contracting, design, certification, prototyping, tests and deployment phases.	2
$\delta_{dep_RU}\{new\ envelope\}$	Duration of the period left to RUs to deploy ETCS on-board equipments supporting the new envelope.	<2

Parameter	Description	Indicative value(year)
$\delta_{\text{not_IM}}$	Duration of the period left to IMs who are still operating the version to be phased out, to notify the intermediate version (X_{n+1} or X_{n+2}) to which they shall migrate.	0,5
$\delta_{\text{nomcomp_RU}\{\text{prev envelope}\}}$	Duration of the nominal compliance period left to RUs to fit their fleets with ETCS on-board equipments supporting the previous envelope. This nominal compliance period includes contracting, design, certification, prototyping, deployment.	2
$\delta_{\text{dep_IM}}$	Duration of the period left to IMs to phase out the obsolete version X_n and to deploy the intermediate version (X_{n+1} or X_{n+2}) they have notified.	1
$\delta_{\text{PO}}(X_n)$	Duration of the phasing out period of the obsolete version X_n . It is equal to the sum of $\delta_{\text{not_IM}}$, $\delta_{\text{nomcomp_RU}\{\text{prev envelope}\}}$ and $\delta_{\text{dep_IM}}$.	
$\delta_{\text{LOP}}(X_{n+3})$	Duration of the initial transition period, during which IMs shall not be allowed to deploy ETCS constituents transmitting information marked with the new version X_{n+3} . It is equal to the sum of $\delta_{\text{PO}}(X_n)$ and $\delta_{\text{dep_RU}\{\text{new envelope}\}}$.	

8.2.4 Model 3: phasing out of oldest X version with no new X version

8.2.4.1 Let the new envelope of X versions enforced in the TSI be $\{X_{n+1}+X_{n+2}\}$, in place of the previous envelope $\{X_n+X_{n+1}+X_{n+2}\}$; X_n is the obsolete version to be phased out; the table here below gives indicative values for the migration parameters.

Parameter	Description	Indicative value(year)
$\delta_{\text{not_IM}}$	Duration of the period left to IMs who are still operating the version to be phased out, to notify the intermediate version (X_{n+1} or X_{n+2}) to which they shall migrate.	0,5
$\delta_{\text{nomcomp_RU}\{\text{prev envelope}\}}$	Duration of the nominal compliance period left to RUs to fit their fleets with ETCS on-board equipments supporting the previous envelope. This nominal compliance period includes contracting, design, certification, prototyping, deployment.	2
$\delta_{\text{dep_IM}}$	Duration of the period left to IMs to phase out the obsolete version X_n and to deploy the intermediate version (X_{n+1} or X_{n+2}) they have notified.	1
$\delta_{\text{PO}}(X_n)$	Duration of the phasing out period of the obsolete version X_n . It is equal to the sum of $\delta_{\text{not_IM}}$, $\delta_{\text{nomcomp_RU}\{\text{prev envelope}\}}$ and $\delta_{\text{dep_IM}}$.	

